

simply
practical

FATH[®]

COMPONENTS



VISUAL MANAGEMENT
VISUAL MANAGEMENT

Container Labelings
Behälterkennzeichnungen 1

Shelf Labelings
Regalkennzeichnungen 2

Floor Markings
Bodenmarkierungen 3

Stickers
Aufkleber 4

Inserting Systems
Einstecksysteme 5

Visual Boards
Visual Boards 6

MATERIAL FLOW
MATERIALFLUSS

Material Transport
Materialtransport 7

Material Supply
Materialbereitstellung 8

LEAN 4.0

EDITION 1.3 | EN-DE

FATH[®]

COMPONENTS



LEAN 4.0

EDITION 1.3 | EN-DE

PRODUCT OVERVIEW *PRODUKTÜBERSICHT*





Container Labelings Behälterkennzeichnungen

- 1 **VISUAL POCKETS
SICHTTASCHEN** 
- 2 **KANBAN LABEL HOLDERS
AND ENVELOPES
KANBAN-ETIKETTENHALTER
UND -HÜLLEN** 

Shelf Labelings Regalkennzeichnungen

- 3 **SHELF LABELINGS
REGALKENNZEICHNUNGEN** 

Floor Markings Bodenmarkierungen

- 4 **FLOOR MARKING TAPES
BODENMARKIERUNGSBÄNDER** 
- 5 **FLOOR MARKINGS SHAPES
AND FLOOR WINDOWS
BODENMARKIERUNGSFORMEN
UND -FENSTER** 
- 6 **FLOOR SIGNS
BODENSCHILDER** 

Stickers Aufkleber

- 7 **STICKERS
AUFKLEBER** 

Insertings Systems Einstecksysteme

- 8 **INSERTING SYSTEMS
EINSTECKSYSTEME** 

Visual Bords Visual Boards

- 9 **VISUAL BORDS
VISUAL BOARDS** 
- 10 **MAGNETIC DOCUMENT WINDOWS
MAGNETISCHE DOKUMENTENFENSTER** 

Material Transport Materialtransport

- 11 **DOLLIES
BODENROLLER** 

Material Supply Materialbereitstellung

- 12 **PARKING RAILS
PARKSCHIENEN** 
- 13 **GUIDING RAILS FIFO
FÜHRUNGSSCHIENEN FIFO** 

VISUAL MANAGEMENT *VISUAL MANAGEMENT*

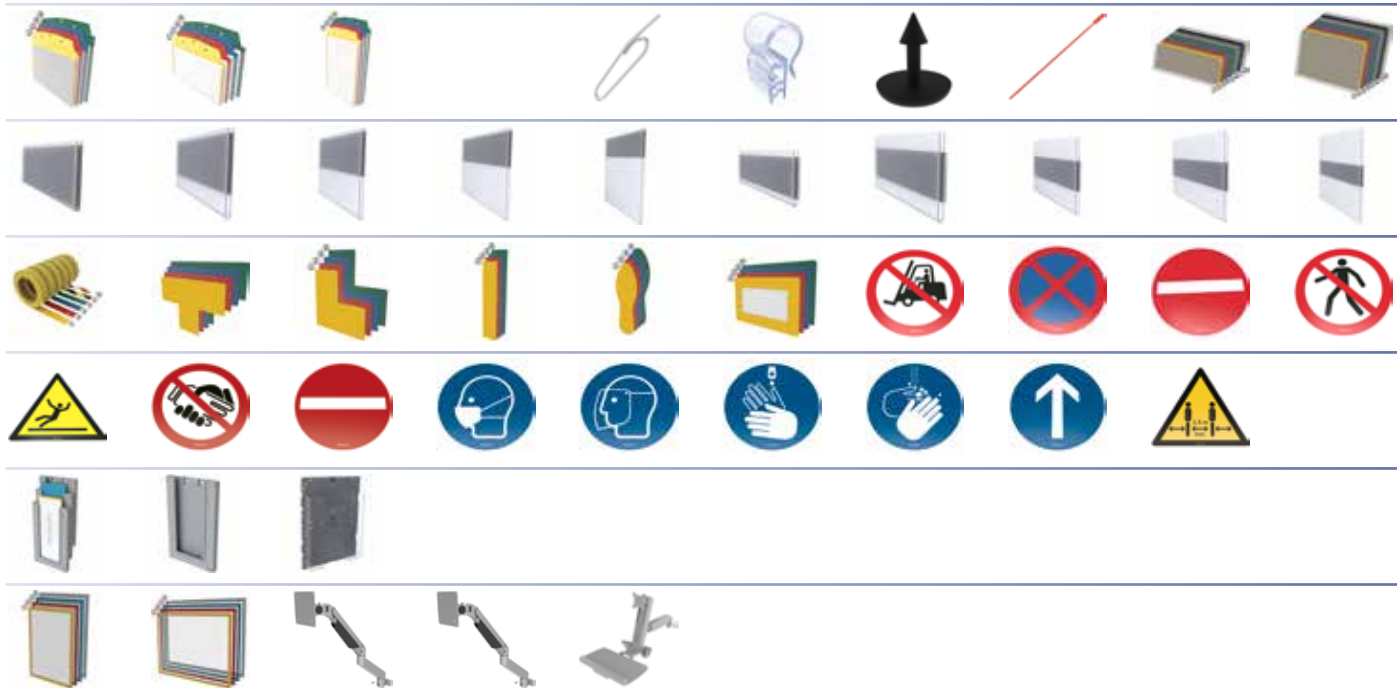

MATERIAL FLOW *MATERIALFLUSS*



	<p>Container Labelings <i>Behälterkennzeichnungen</i> 1</p>
	<p>Shelf Labelings <i>Regalkennzeichnungen</i> 2</p>
	<p>Floor Markings <i>Bodenmarkierungen</i> 3</p>
	<p>Stickers <i>Aufkleber</i> 4</p>
	<p>Inserting Systems <i>Einstecksysteme</i> 5</p>
	<p>Visual Boards <i>Visual Boards</i> 6</p>

	<p>Material Transport <i>Materialtransport</i> 7</p>
	<p>Material Supply <i>Materialbereitstellung</i> 8</p>

CONTAINER LABELINGS *BEHÄLTERKENNZEICHNUNGEN*



Container Labelings
Behälterkennzeichnungen 1

Shelf Labelings
Regalkennzeichnungen 2

Floor Markings
Bodenmarkierungen 3

Stickers
Aufkleber 4













Inserting Systems
Einstecksysteme 5

Visual Boards
Visual Boards 6

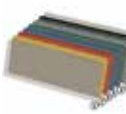
MATERIAL FLOW *MATERIALFLUSS*

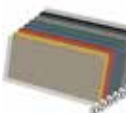
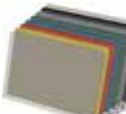
Material Transport
Materialtransport 7

Material Supply
Materialbereitstellung 8

	Attached Visual Pocket DIN A5 Landscape - 8.3" x 5.8" <i>Anhänge-Sichttasche DIN A5 quer</i>	15		U-loop Steel Clamp for Visual Pocket <i>Bügelklemme für Sichttasche</i>	25
	Attached Visual Pocket 1/3 DIN A4 Portrait - 8.3" x 3.9" <i>Anhänge-Sichttasche 1/3 DIN A4 hoch</i>	16		Lattice Box Clip for Visual Pocket <i>Gitterbox-Clip für Sichttasche</i>	26
	Attached Visual Pocket DIN A4 Portrait - 8.3" x 11.7" <i>Anhänge-Sichttasche DIN A4 hoch</i>	17		Plastic Pin for Visual Pocket <i>Kunststoffpiekser für Sichttasche</i>	27
	Self-adhesive Visual Pocket DIN A5 Landscape - 8.3" x 5.8" <i>Selbstklebende Sichttasche DIN A5 quer</i>	18		Plastic Tie for Visual Pocket <i>Kunststoffbinder für Sichttasche</i>	28
	Self-adhesive Visual Pocket 1/3 DIN A4 Portrait - 8.3" x 3.9" <i>Selbstklebende Sichttasche 1/3 DIN A4 hoch</i>	19		Top Open KANBAN Envelope 200 x 67 - 7.9" x 2.6" <i>Oben offene KANBAN Hülle 200 x 67</i>	33
	Self-adhesive Visual Pocket DIN A4 Portrait - 8.3" x 11.7" <i>Selbstklebende Sichttasche DIN A4 hoch</i>	20		Top Open KANBAN Envelope 200 x 85 - 7.9" x 3.4" <i>Oben offene KANBAN Hülle 200 x 85</i>	34
	Magnetic Visual Pocket DIN A5 Landscape - 8.3" x 5.8" <i>Magnetische Sichttasche DIN A5 quer</i>	21		Top Open KANBAN Envelope 200 x 135 - 7.9" x 5.3" <i>Oben offene KANBAN Hülle 200 x 135</i>	35
	Magnetic Visual Pocket 1/3 DIN A4 Portrait - 8.3" x 3.9" <i>Magnetische Sichttasche 1/3 DIN A4 hoch</i>	22		Side Open KANBAN Envelope 200 x 67 - 7.9" x 2.6" <i>Seitlich offene KANBAN Hülle 200 x 67</i>	36
	Magnetic Visual Pocket DIN A4 Portrait - 8.3" x 11.7" <i>Magnetische Sichttasche DIN A4 hoch</i>	23		Side Open KANBAN Envelope 200 x 85 - 7.9" x 3.4" <i>Seitlich offene KANBAN Hülle 200 x 85</i>	37
	Magnetic Visual Pocket DIN A4 Portrait - 8.3" x 11.7" <i>Magnetische Sichttasche DIN A4 hoch</i>	24		Side Open KANBAN Envelope 200 x 135 - 7.9" x 5.3" <i>Seitlich offene KANBAN Hülle 200 x 135</i>	38



KANBAN Clip Document Holder 70 x 30 - 2.8" x 1.2"
KANBAN-Clip Dokumentenhalter 70 x 30

39



Overhanging KANBAN Label Holder
Überhänge-KANBAN-Etikettenhalter

40



Self-adhesive KANBAN Label Holder
Selbstklebende KANBAN-Etikettenhalter

41



Magnetic KANBAN Label Holder
Magnetische KANBAN-Etikettenhalter

42

1

2

3

4

5

6

7

8

simply
practical

VISUAL POCKETS SICHTTASCHEN

FATH®
COMPONENTS



REUSABLE ADHESIVE
MULTI-USE KLEBER

MULTI-USE: LABEL YOUR WAREHOUSE RELIABLY WITH FATH'S VERSATILE VISUAL POCKETS MULTI-USE: LAGERBEHÄLTER FLEXIBEL UND ZUVERLÄSSIG KENNZEICHNEN MIT DEN FATH SICHTTASCHEN

Magnetic, reusable self-adhesive or attachable with accessories
Made of durable plastic with a reinforced header, the Visual Pockets are available in the following versions: magnetic, reusable self-adhesive or attachable with accessories. Each version is available in four colors and three formats. You can use them to label all standard crates, boxes, and containers, whether they are made of plastic, metal, wood or glass. You can choose from numerous attachment accessories that are compatible with Euro boxes, plastic crates and trays, lattice boxes, SLCs, heavy load carriers, and many more. The front of the Visual Pocket is made of a transparent film while the back is made of a colored plastic. Thanks to the nature of the transparent film, a scanner can easily read the inserted documentation without it needing to be removed.

Visual Pockets for easily labeling all standard containers

- Magnetic, reusable self-adhesive or attachable with accessories
- Scanner readable
- A wide variety of colors and formats
- Numerous attachment options
- Durable with reinforced header pieces

- REUSABLE ADHESIVE TAPES
- NEODYMIUM MAGNET WITH ULTRA-HOLDING FORCE

Selbstklebend, magnetisch oder zum Anhängen

Die Sichttaschen aus strapazierfähigem Kunststoff mit verstärktem Kopfteil sind in den Varianten selbstklebend (multi-use), magnetisch und zum Anhängen erhältlich – jeweils in vier Farben und drei Formaten. Damit können Sie alle gängigen Kisten und Behälter aus Kunststoff, Metall, Holz oder Glas zuverlässig kennzeichnen. Für Euroboxen, Kunststoffkästen, Gitterboxen, KLT und GLT etc. stehen zahlreiche Befestigungsmöglichkeiten zur Wahl. Die Vorderseite der Sichttasche besteht aus transparenter Klarsichtfolie, die rückseitige Folie aus farbigem Kunststoff. Durch die Klarsichtfolie ist das automatische Einlesen der eingesteckten Papiere mit dem Scanner problemlos möglich – ohne Entnahme der Belege.

Sichttaschen für die einfache Kennzeichnung aller gängigen Behälter

- Zum Anhängen, selbstklebend (multi-use) und magnetisch
- Scannerlesbar
- Viele unterschiedliche Farben und Formate
- Zahlreiche flexible Befestigungsmöglichkeiten
- Strapazierfähig mit verstärktem Kopfteil

- WIEDERVERWENDBARE KLEBESTREIFEN (MULTI-USE)
- NEODYMMAGNETE MIT ULTRA HAFTKRAFT

UNIQUE WORLDWIDE: REUSABLE SELF-ADHESIVE VISUAL POCKETS WELTWEIT EINZIGARTIG: SELBSTKLEBENDE SICHTTASCHEN ZUR MEHRFACHNUTZUNG

This is new: FATH's Visual Pockets are able to be reused again and again since the innovative adhesive retains its adhesion properties even after being detached. If a container needs to be re-labeled, the reusable self-adhesive FATH Visual Pocket can simply be removed. While conventional adhesives leave stubborn residues that need to be painstakingly removed, the new self-adhesive FATH products can be removed in one piece, easily and completely free of residue. Our adhesive remains adhered to the Visual Pocket and can be reattached elsewhere multiple times. This means that FATH's self-adhesive Visual Pockets are also suitable for temporary labeling. That is both lean and sustainable.

Das ist neu: Die selbstklebenden FATH Sichttaschen sind vielfach wiederverwendbar, da der innovative Kleber auch nach dem Ablösen seine Haftfunktion behält. Muss ein Behälter neu gekennzeichnet werden, kann die selbstklebende FATH Sichttasche einfach wieder abgelöst werden. Während herkömmliche Kleber dabei hartnäckige Kleberückstände hinterlassen, die mühsam entfernt und fachgerecht entsorgt werden müssen, sind die neuartigen selbstklebenden Produkte von FATH völlig rückstandsfrei und in einem Stück ablösbar. Der Kleber bleibt an der Sichttasche haften, die mehrfach an anderer Stelle wieder aufgeklebt werden kann. Damit eignen sich die selbstklebenden Sichttaschen von FATH auch zur temporären Kennzeichnung. Das ist lean und zugleich nachhaltig!

**ATTACHMENT IS POSSIBLE FOR VIRTUALLY ANY SURFACE AND ANY WAREHOUSE CONTAINER TYPE
ANBRINGUNGSMÖGLICHKEITEN FÜR NAHEZU JEDEN LAGERBEHÄLTER UND JEDE OBERFLÄCHE**



Reusable Self-Adhesive Visual Pockets

An adhesive strip is attached to the back of the reusable self-adhesive Visual Pocket. Remove the liner from the double-sided adhesive strip, press the Visual Pocket onto a suitable surface and you're done. This version of the Visual Pockets is especially suitable for wood, glass, plastic and precious metal containers. The Industrial Adhesive compensates for unevenness and offers a high degree of adhesion on many load-bearing surfaces immediately after attachment.

Selbstklebende Sichttaschen

Auf der Rückseite der mehrfach verwendbaren selbstklebenden Sichttaschen ist ein Klebestreifen angebracht. Trennabdeckung des doppelseitigen Klebestreifens abziehen, Sichttasche auf dem geeigneten Untergrund andrücken, fertig! Diese Variante eignet sich besonders für Behälter aus Metall, Holz, Kunststoff, Edelmetall oder Glas. Der industrietaugliche Kleber gleicht Unebenheiten aus und bietet auf vielen tragenden Untergründen eine hohe Soforthaftkraft nach dem Andrücken.



Magnetic Visual Pockets

FATH's Magnetic Visual Pockets feature two welded-in neodymium magnets. They are suitable for attaching to all ferrous surfaces and are able to withstand strong vibrations thanks to strength of the neodymium magnets. Two individual magnets allow the Visual Pockets to be attached to round objects such as barrels and pumps. They can also remain firmly attached to metal wall paneling that is fluted or has a profiled surface.

Magnetische Sichttaschen

Die magnetischen Sichttaschen von FATH sind mit zwei eingeschweißten Neodymmagneten ausgestattet. Sie eignen sich zur Befestigung auf allen eisenhaltigen Untergründen und halten dank hoher magnetischer Haftkraft auch starken Erschütterungen stand. Die zwei Einzelmagnete ermöglichen die Anbringung an runden Objekten, wie Fässern, Pumpen usw. Auch an metallischen Wandverkleidungen mit geriffelter oder profilierter Oberfläche halten die magnetischen Sichttaschen zuverlässig.





Attached Visual Pockets

There are many accessories available to mount FATH's Attachable Visual Pockets. Brackets are attached through the punch holes in the Visual Pocket's reinforced header piece. The availability of different fastening options means Visual Pockets can be attached to almost any container – from SLCs and barrels through to drums and special load carriers.

Anhänge-Sichttasche

Für die Befestigung der FATH Anhänge-Sichttasche ist vielseitiges Zubehör erhältlich. Die Halter werden in den Lochstanzungen im verstärkten Kopfteil der Sichttasche angebracht. Die unterschiedlichen Befestigungsmöglichkeiten erlauben das Anbringen an nahezu jedem Behältnis – vom Kleinladungsträger über Fässer und Tonnen bis zum Sonderladungsträger.

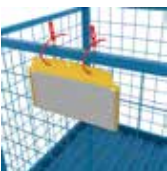
	<p>U-loop steel clamp for Visual Pockets For films, thinner cardboard packaging, and outer packaging</p>	<p>Bügelklemme für Sichttasche Für Folien, dünnere Kartonagen, Umverpackungen</p>
	<p>Plastic pin for Visual Pockets For lattice boxes and steel cable for ceiling signage</p>	<p>Kunststoffpiekser für Sichttasche Für dickere Kartonagen, Schaumstoff, Textilien, Plastiksäcke</p>
	<p>Lattice box clip for Visual Pockets For lattice boxes and steel cable for ceiling signage</p>	<p>Gitterbox-Clip für Sichttasche Für Gitterboxen, Stahlseile als Deckenbeschilderung</p>
	<p>Plastic tie for Visual Pockets (multi-use) For profiles, ducts, lattice boxes, and containers with handles</p>	<p>Kunststoffbinder für Sichttasche (mehrfach verwendbar) Für Profile, Leitungen, Gitterboxen, Behälter mit Griffen</p>



VERSIONS AUSFÜHRUNGEN

Visual Pockets are available in the following versions:

Reusable Self-adhesive
Attachable
Magnetic
Available in all common formats and colors.

Die Sichttaschen sind in folgenden Ausführungen erhältlich:

*Selbstklebend (multit-use)
Zum Anhängen
Magnetisch
Erhältlich in allen gängigen Formaten und Farben.*

LEAN 4.0: EFFECTIVE CONTAINER IDENTIFICATION AND GREATER SUSTAINABILITY **LEAN 4.0: EFFEKTIVE BEHÄLTERKENNZEICHNUNG UND MEHR NACHHALTIGKEIT**

FATH's Visual Pockets are part of the LEAN product family. Products which allow you to design your production and logistics processes to be more efficient and leaner.

Die FATH Sichttaschen sind Teil der LEAN-Produktreihe – Produkte, mit denen Sie Ihre Produktions- und Logistikprozesse auf einfache Weise effizienter und schlanker gestalten können.

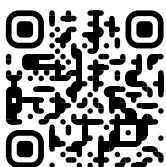

You would like to know more about the FATH Visual Pockets?

visual-pocket.fath24.com

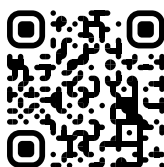

Sie möchten die FATH Sichttaschen besser kennen lernen?

sichttasche.fath24.de

ATTACHED VISUAL POCKET
DIN A5 LANDSCAPE - 8.3" X 5.8"

ANHÄNGE-SICHTTASCHE
DIN A5 QUER

Model	For attachment	Ausführung	zum Anhängen
Description	Strong and durable visible pocket for hanging or inserting, with pre-punched hole pattern for attaching to various load carriers using optional accessories; Tear-resistant and stretchable transparent foil with restoring capacity, scanner-compatible	Beschreibung	<i>belastbare und langlebige Sichttasche zum Anhängen oder Einstecken, mit vorgestanztem Lochbild zum Befestigen an verschiedensten Ladungsträgern mittels optionalem Zubehör; reißfeste und dehnbare Sichtfolie mit Rückstellvermögen, scannertauglich</i>
Material	Plastic PVC	Material	Kunststoff PVC
Color	Yellow, red, blue, green	Farbe	gelb, rot, blau, grün
Pack Quantity	10 pieces	Liefereinheit	10 Stück
Tip	Compatible U-loop Steel Clamp see 02011E02; Compatible Lattice Box Clip see 02011E03; Compatible Plastic Pin see 02011E04; Compatible Plastic Tie see 02011E05	Hinweis	<i>passende Bügelklemme siehe 02011E02; passender Gitterbox-Clip siehe 02011E03; passender Kunststoffpiekser siehe 02011E04; passender Kunststoffbinder siehe 02011E05</i>

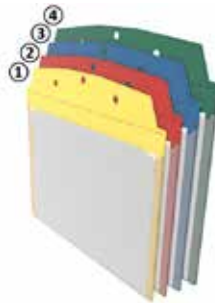
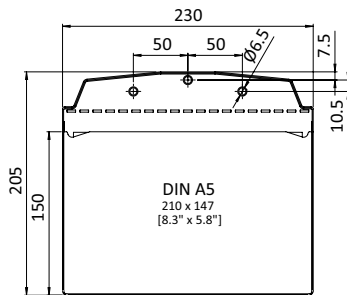

Fig. Abb.	Attached Visual Pocket DIN A5 Landscape - 8.3" x 5.8" <i>Anhänge-Sichttasche DIN A5 quer</i>	Color Farbe	Weight [g] Gewicht [g]	Part # Teil-Nr.
①		Yellow ≈ RAL 1018 <i>gelb</i>	27.6	02011A5LH15
②		Red ≈ RAL 3020 <i>rot</i>	27.6	02011A5LH31
③		Blue ≈ RAL 5017 <i>blau</i>	27.6	02011A5LH55
④		Green ≈ RAL 6016 <i>grün</i>	27.6	02011A5LH63



ATTACHED VISUAL POCKET
1/3 DIN A4 PORTRAIT - 8.3" X 3.9"

ANHÄNGE-SICHTTASCHE
1/3 DIN A4 HOCH

<p>Model For attachment</p> <p>Description Strong and durable visible pocket for hanging or inserting, with pre-punched hole pattern for attaching to various load carriers using optional accessories; Tear-resistant and stretchable transparent foil with restoring capacity, scanner-compatible</p> <p>Material Plastic PVC</p> <p>Color Yellow, red, blue, green</p> <p>Pack Quantity 10 pieces</p> <p>Tip Compatible U-loop Steel Clamp see 02011E02; Compatible Lattice Box Clip see 02011E03; Compatible Plastic Pin see 02011E04; Compatible Plastic Tie see 02011E05</p>	<p>Ausführung zum Anhängen</p> <p>Beschreibung belastbare und langlebige Sichttasche zum Anhängen oder Einstecken, mit vorgestanztem Lochbild zum Befestigen an verschiedensten Ladungsträgern mittels optionalem Zubehör; reißfeste und dehnbare Sichtfolie mit Rückstellvermögen, scannertauglich</p> <p>Material Kunststoff PVC</p> <p>Farbe gelb, rot, blau, grün</p> <p>Liefereinheit 10 Stück</p> <p>Hinweis passende Bügelklemme siehe 02011E02; passender Gitterbox-Clip siehe 02011E03; passender Kunststoffpiekser siehe 02011E04; passender Kunststoffbinder siehe 02011E05</p>
--	--

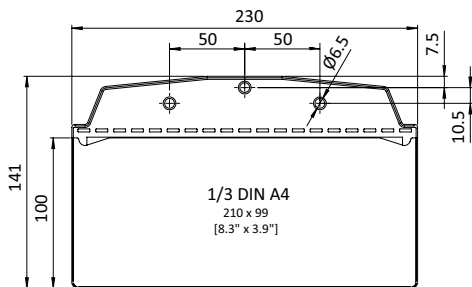

Fig. Abb.	Attached Visual Pocket 1/3 DIN A4 Portrait - 8.3" x 3.9" Anhänge-Sichttasche 1/3 DIN A4 hoch	Color Farbe	Weight [g] Gewicht [g]	Part # Teil-Nr.
①		Yellow ≈ RAL 1018 <i>gelb</i>	12.6	02011A1/3H15
②		Red ≈ RAL 3020 <i>rot</i>	12.6	02011A1/3H31
③		Blue ≈ RAL 5017 <i>blau</i>	12.6	02011A1/3H55
④		Green ≈ RAL 6016 <i>grün</i>	12.6	02011A1/3H63



ATTACHED VISUAL POCKET
DIN A4 PORTRAIT - 8.3" X 11.7"

ANHÄNGE-SICHTTASCHE
DIN A4 HOCH

Model	For attachment	Ausführung	zum Anhängen
Description	Strong and durable visible pocket for hanging or inserting, with pre-punched hole pattern for attaching to various load carriers using optional accessories; Tear-resistant and stretchable transparent foil with restoring capacity, scanner-compatible	Beschreibung	belastbare und langlebige Sichttasche zum Anhängen oder Einstecken, mit vorgestanzttem Lochbild zum Befestigen an verschiedensten Ladungsträgern mittels optionalem Zubehör; reißfeste und dehnbare Sichtfolie mit Rückstellvermögen, scannertauglich
Material	Plastic PVC	Material	Kunststoff PVC
Color	Yellow, red, blue, green	Farbe	gelb, rot, blau, grün
Pack Quantity	10 pieces	Liefereinheit	10 Stück
Tip	Compatible U-loop Steel Clamp see 02011E02; Compatible Lattice Box Clip see 02011E03; Compatible Plastic Pin see 02011E04; Compatible Plastic Tie see 02011E05	Hinweis	passende Bügelklemme siehe 02011E02; passender Gitterbox-Clip siehe 02011E03; passender Kunststoffpiekser siehe 02011E04; passender Kunststoffbinder siehe 02011E05

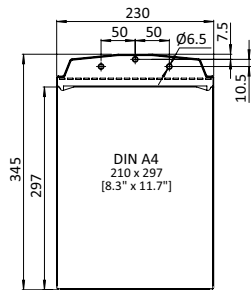

Fig. Abb.	Attached Visual Pocket DIN A4 Portrait - 8.3" x 11.7" Anhänge-Sichttasche DIN A4 hoch	Color Farbe	Weight [g] Gewicht [g]	Part # Teil-Nr.
①		Yellow ≈ RAL 1018 <i>gelb</i>	51.0	02011A4PH15
②		Red ≈ RAL 3020 <i>rot</i>	51.0	02011A4PH31
③		Blue ≈ RAL 5017 <i>blau</i>	51.0	02011A4PH55
④		Green ≈ RAL 6016 <i>grün</i>	51.0	02011A4PH63



SELF-ADHESIVE VISUAL POCKET
DIN A5 LANDSCAPE - 8.3" X 5.8"

SELBSTKLEBENDE SICHTTASCHE
DIN A5 QUER

<p>Model Self-adhesive (multi-use)</p> <p>Description Strong and durable visible pocket for flexible adhesion even on uneven surfaces, removable without leaving any residue, reusable on supporting surfaces thanks to multi-use properties; Tear-resistant and stretchable transparent foil with restoring capacity, scanner-compatible</p> <p>Material Visual Pocket: Plastic PVC Adhesive strip: PE foam, reusable</p> <p>Color Yellow, red, blue, green</p> <p>Pack Quantity 10 pieces</p>	<p>Ausführung selbstklebend (multi-use)</p> <p>Beschreibung belastbare und langlebige Sichttasche zum flexiblen Ankleben auch auf unebenen Oberflächen, rückstandsfrei entfernbar, mehrfach wiederverwendbar auf tragenden Untergründen dank multi-use Eigenschaft; reißfeste und dehnbare Sichtfolie mit Rückstellvermögen, scannertauglich</p> <p>Material Sichttasche: Kunststoff PVC Klebestreifen: PE-Schaumstoff, wiederverwendbar</p> <p>Farbe gelb, rot, blau, grün</p> <p>Lieferinheit 10 Stück</p>
--	---

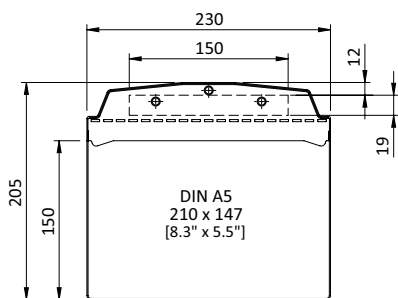
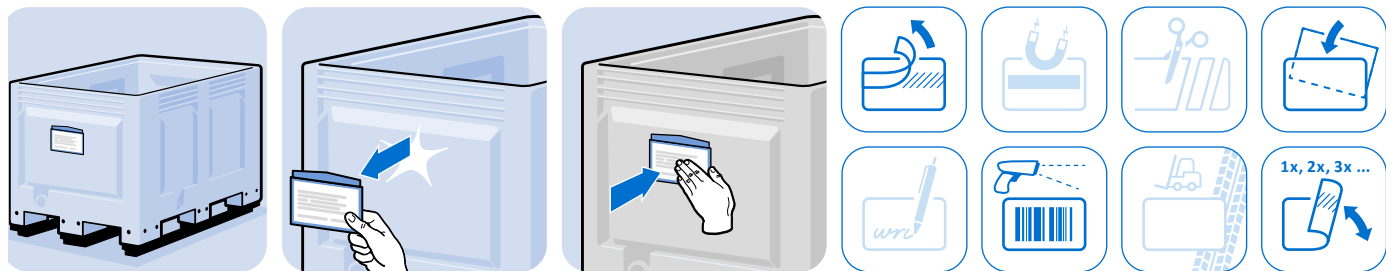

Fig. Abb.	Self-adhesive Visual Pocket DIN A5 Landscape - 8.3" x 5.8" <i>Selbstklebende Sichttasche DIN A5 quer</i>	Color <i>Farbe</i>	Weight [g] <i>Gewicht [g]</i>	Part # <i>Teil-Nr.</i>
①		Yellow ≈ RAL 1018 <i>gelb</i>	28.0	02011A5LA15
②		Red ≈ RAL 3020 <i>rot</i>	28.0	02011A5LA31
③		Blue ≈ RAL 5017 <i>blau</i>	28.0	02011A5LA55
④		Green ≈ RAL 6016 <i>grün</i>	28.0	02011A5LA63



SELF-ADHESIVE VISUAL POCKET
1/3 DIN A4 PORTRAIT - 8.3" X 3.9"

SELBSTKLEBENDE SICHTTASCHE
1/3 DIN A4 HOCH

<p>Model Self-adhesive (multi-use)</p> <p>Description Strong and durable visible pocket for flexible adhesion even on uneven surfaces, removable without leaving any residue, reusable on supporting surfaces thanks to multi-use properties; Tear-resistant and stretchable transparent foil with restoring capacity, scanner-compatible</p> <p>Material Visual Pocket: Plastic PVC Adhesive strip: PE foam, reusable</p> <p>Color Yellow, red, blue, green</p> <p>Pack Quantity 10 pieces</p>	<p>Ausführung selbstklebend (multi-use)</p> <p>Beschreibung belastbare und langlebige Sichttasche zum flexiblen Ankleben auch auf unebenen Oberflächen, rückstandsfrei entfernbar, mehrfach wiederverwendbar auf tragenden Untergründen dank multi-use Eigenschaft; reißfeste und dehnbare Sichtfolie mit Rückstellvermögen, scannertauglich</p> <p>Material Sichttasche: Kunststoff PVC Klebestreifen: PE-Schaumstoff, wiederverwendbar</p> <p>Farbe gelb, rot, blau, grün</p> <p>Liefereinheit 10 Stück</p>
--	--

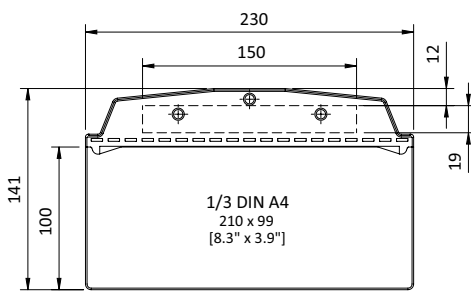
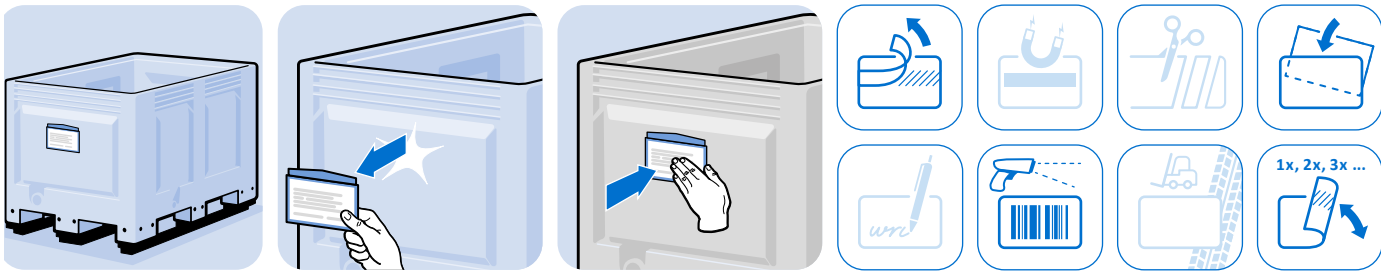

Fig. Abb.	Self-adhesive Visual Pocket 1/3 DIN A4 Portrait - 8.3" x 3.9" Selbstklebende Sichttasche 1/3 DIN A4 hoch	Color Farbe	Weight [g] Gewicht [g]	Part # Teil-Nr.
①		Yellow ≈ RAL 1018 <i>gelb</i>	13.0	02011A1/3A15
②		Red ≈ RAL 3020 <i>rot</i>	13.0	02011A1/3A31
③		Blue ≈ RAL 5017 <i>blau</i>	13.0	02011A1/3A55
④		Green ≈ RAL 6016 <i>grün</i>	13.0	02011A1/3A63



SELF-ADHESIVE VISUAL POCKET
DIN A4 PORTRAIT - 8.3" X 11.7"

SELBSTKLEBENDE SICHTTASCHE
DIN A4 HOCH

Model	Self-adhesive (multi-use)	Ausführung	selbstklebend (multi-use)
Description	Strong and durable visible pocket for flexible adhesion even on uneven surfaces, removable without leaving any residue, reusable on supporting surfaces thanks to multi-use properties; Tear-resistant and stretchable transparent foil with restoring capacity, scanner-compatible	Beschreibung	belastbare und langlebige Sichttasche zum flexiblen Ankleben auch auf unebenen Oberflächen, rückstandsfrei entfernbar, mehrfach wiederverwendbar auf tragenden Untergründen dank multi-use Eigenschaft; reißfeste und dehnbare Sichtfolie mit Rückstellvermögen, scannertauglich
Material	Visual Pocket: Plastic PVC Adhesive strip: PE foam, reusable	Material	Sichttasche: Kunststoff PVC Klebestreifen: PE-Schaumstoff, wiederverwendbar
Color	Yellow, red, blue, green	Farbe	gelb, rot, blau, grün
Pack Quantity	10 pieces	Lieferinheit	10 Stück

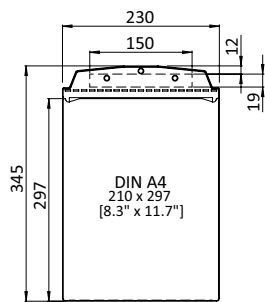
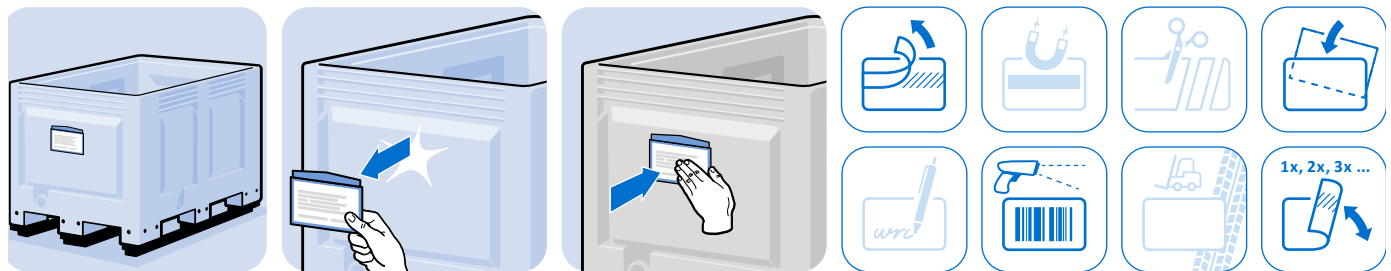

Fig. Abb.	Self-adhesive Visual Pocket DIN A4 Portrait - 8.3" x 11.7" Selbstklebende Sichttasche DIN A4 hoch	Color Farbe	Weight [g] Gewicht [g]	Part # Teil-Nr.
①		Yellow ≈ RAL 1018 <i>gelb</i>	51.0	02011A4PA15
②		Red ≈ RAL 3020 <i>rot</i>	51.0	02011A4PA31
③		Blue ≈ RAL 5017 <i>blau</i>	51.0	02011A4PA55
④		Green ≈ RAL 6016 <i>grün</i>	51.0	02011A4PA63



MAGNETIC VISUAL POCKET
DIN A5 LANDSCAPE - 8.3" X 5.8"

Model Magnetic (neodymium)
Description Strong and durable visible pocket for magnetic attachment even on offset or round surfaces such as lattice boxes or drums, vibration and shock resistant on machines and during transportation thanks to the strong holding power of the high-performance neodymium magnets; Tear-resistant and stretchable transparent foil with restoring capacity, scanner-compatible
Material Visual Pocket: Plastic PVC
 Magnets: Neodymium
Color Yellow, red, blue, green
Pack Quantity 10 pieces

MAGNETISCHE SICHTTASCHE
DIN A5 QUER

Ausführung magnetisch (Neodym)
Beschreibung belastbare und langlebige Sichttasche zur magnetischen Befestigung auch auf versetzten oder runden Oberflächen z.B. von Gitterboxen oder Fässern, vibrations- und erschütterungsfest an Maschinen und beim Transport dank hoher Haftkraft von Hochleistungs-Neodym-Magneten; reißfeste und dehnbare Sichtfolie mit Rückstellvermögen, scannertauglich
Material Sichttasche: Kunststoff PVC
 Magnete: Neodym
Farbe gelb, rot, blau, grün
Liefereinheit 10 Stück

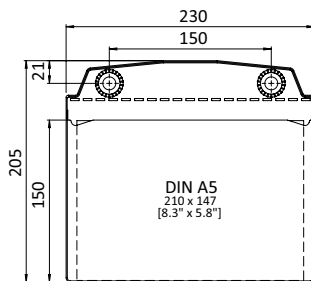
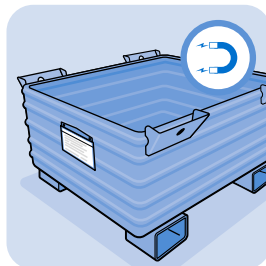
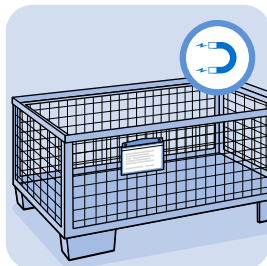

Fig. Abb. Magnetic Visual Pocket DIN A5 Landscape - 8.3" x 5.8"
 Magnetische Sichttasche DIN A5 quer

Fig. Abb.	Color Farbe	Weight [g] Gewicht [g]	Part # Teil-Nr.
①	Yellow ≈ RAL 1018 <i>gelb</i>	38.0	02011A5LM15
②	Red ≈ RAL 3020 <i>rot</i>	38.0	02011A5LM31
③	Blue ≈ RAL 5017 <i>blau</i>	38.0	02011A5LM55
④	Green ≈ RAL 6016 <i>grün</i>	38.0	02011A5LM63



MAGNETIC VISUAL POCKET
1/3 DIN A4 PORTRAIT - 8.3" X 3.9"

MAGNETISCHE SICHTTASCHE
1/3 DIN A4 HOCH

Model	Magnetic (neodymium)	Ausführung	magnetisch (Neodym)
Description	Strong and durable visible pocket for magnetic attachment even on offset or round surfaces such as lattice boxes or drums, vibration and shock resistant on machines and during transportation thanks to the strong holding power of the high-performance neodymium magnets; Tear-resistant and stretchable transparent foil with restoring capacity, scanner-compatible	Beschreibung	belastbare und langlebige Sichttasche zur magnetischen Befestigung auch auf versetzten oder runden Oberflächen z.B. von Gitterboxen oder Fässern, vibrations- und erschütterungsfest an Maschinen und beim Transport dank hoher Haftkraft von Hochleistungs-Neodym-Magneten; reißfeste und dehnbare Sichtfolie mit Rückstellvermögen, scannertauglich
Material	Visual Pocket: Plastic PVC Magnets: Neodymium	Material	Sichttasche: Kunststoff PVC Magnete: Neodym
Color	Yellow, red, blue, green	Farbe	gelb, rot, blau, grün
Pack Quantity	10 pieces	Liefereinheit	10 Stück

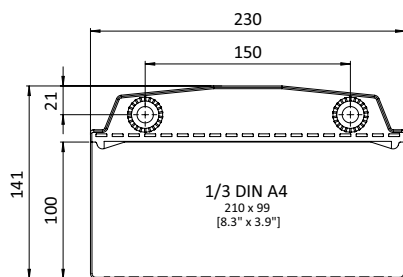
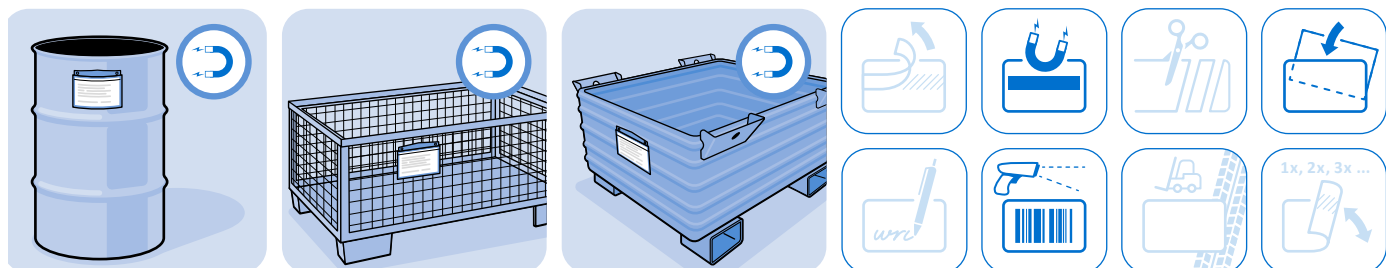

Fig. Abb.	Magnetic Visual Pocket 1/3 DIN A4 Portrait - 8.3" x 3.9" Magnetische Sichttasche 1/3 DIN A4 hoch	Color Farbe	Weight [g] Gewicht [g]	Part # Teil-Nr.
①		Yellow ≈ RAL 1018 <i>gelb</i>	35.0	02011A1/3M15
②		Red ≈ RAL 3020 <i>rot</i>	35.0	02011A1/3M31
③		Blue ≈ RAL 5017 <i>blau</i>	35.0	02011A1/3M55
④		Green ≈ RAL 6016 <i>grün</i>	35.0	02011A1/3M63



**MAGNETIC VISUAL POCKET
 DIN A4 PORTRAIT - 8.3" X 11.7"**

**MAGNETISCHE SICHTTASCHE
 DIN A4 HOCH**

Model	Magnetic (neodymium)	Ausführung	magnetisch (Neodym)
Description	Strong and durable visible pocket for magnetic attachment even on offset or round surfaces such as lattice boxes or drums, vibration and shock resistant on machines and during transportation thanks to the strong holding power of the high-performance neodymium magnets; Tear-resistant and stretchable transparent foil with restoring capacity, scanner-compatible	Beschreibung	belastbare und langlebige Sichttasche zur magnetischen Befestigung auch auf versetzten oder runden Oberflächen z.B. von Gitterboxen oder Fässern, vibrations- und erschütterungsfest an Maschinen und beim Transport dank hoher Haftkraft von Hochleistungs-Neodym-Magneten; reißfeste und dehnbare Sichtfolie mit Rückstellvermögen, scannertauglich
Material	Visual Pocket: Plastic PVC Magnets: Neodymium	Material	Sichttasche: Kunststoff PVC Magnete: Neodym
Color	Yellow, red, blue, green	Farbe	gelb, rot, blau, grün
Pack Quantity	10 pieces	Liefereinheit	10 Stück

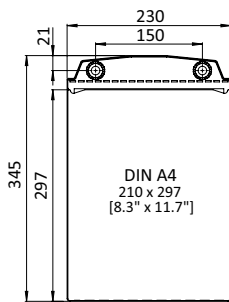
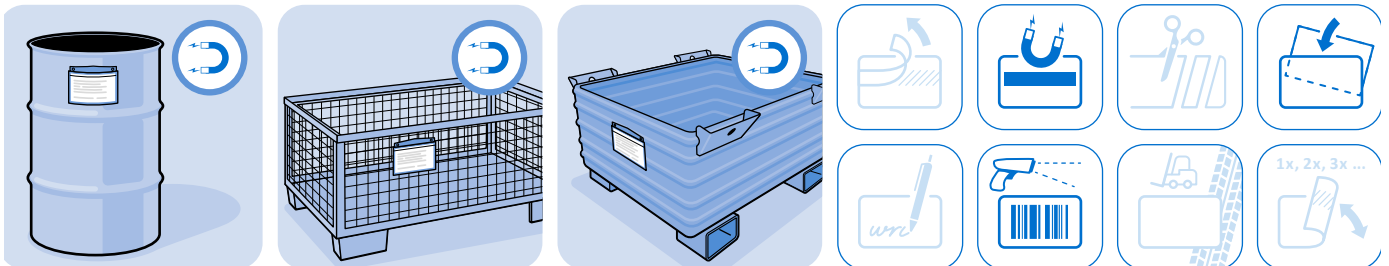

Fig. Abb.	Magnetic Visual Pocket DIN A4 Portrait - 8.3" x 11.7" Magnetische Sichttasche DIN A4 hoch	Color Farbe	Weight [g] Gewicht [g]	Part # Teil-Nr.
①		Yellow ≈ RAL 1018 <i>gelb</i>	54.0	02011A4PM15
②		Red ≈ RAL 3020 <i>rot</i>	54.0	02011A4PM31
③		Blue ≈ RAL 5017 <i>blau</i>	54.0	02011A4PM55
④		Green ≈ RAL 6016 <i>grün</i>	54.0	02011A4PM63



U-LOOP STEEL CLAMP FOR VISUAL POCKET

BÜGELKLEMMME FÜR SICHTTASCHE

Model	For hanging up on foils and meshes	Ausführung	zum Einhängen an Folien und Gittern
Description	Universal U-loop for hanging up attached visual pockets in foils or on rods of lattice boxes and mesh panels	Beschreibung	Universeller Bügel zum Einhängen von Anhängesichttaschen in Folien oder an Gitterstäben von Gitterboxen und Gitterflächen
Material	Steel	Material	Stahl
Surface	Zinc plated	Oberfläche	verzinkt
Pack Quantity	100 pieces	Liefereinheit	100 Stück
Tip	Compatible attached visual pockets see 02011A5LH15, 02011A4PH15 and 02011A1/3H15	Hinweis	passende Anhängesichttaschen siehe 02011A5LH15, 02011A4PH15 und 02011A1/3H15

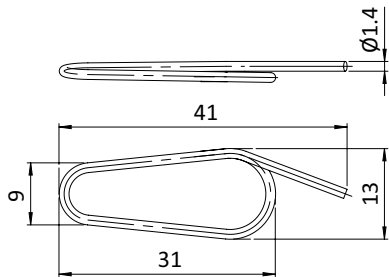

U-loop Steel Clamp for Visual Pocket
 Bügelklemme für Sichttasche

Weight [g]
 Gewicht [g]

Part #
 Teil-Nr.

1.0

02011E02



LATTICE BOX CLIP FOR VISUAL POCKET

GITTERBOX-CLIP FÜR SICHTTASCHE

<p>Model For clamping on lattice boxe frames</p> <p>Description Clip with excellent grip to clip-on attached visual pockets to the frame of lattice boxes</p> <p>Material Plastic PVC</p> <p>Color Transparent</p> <p>Pack Quantity 100 pieces</p> <p>Tip Compatible attached visual pockets see 02011A5LH15, 02011A4PH15 and 02011A1/3H15</p>	<p>Ausführung zum Klemmen an Gitterbox-Rahmen</p> <p>Beschreibung Clip mit ausgezeichneter Klemmwirkung zum Anklipsen von Anhänge-Sichttaschen an den Rahmen von Gitterboxen</p> <p>Material Kunststoff PVC</p> <p>Farbe transparent</p> <p>Liefereinheit 100 Stück</p> <p>Hinweis passende Anhänge-Sichttaschen siehe 02011A5LH15, 02011A4PH15 und 02011A1/3H15</p>
--	--

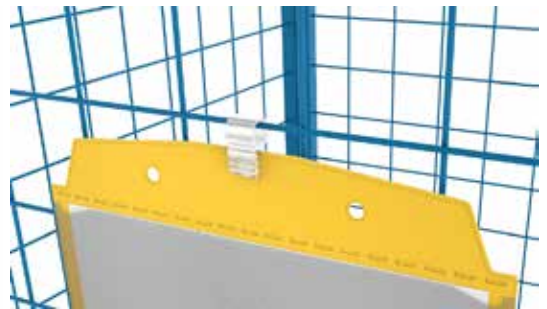
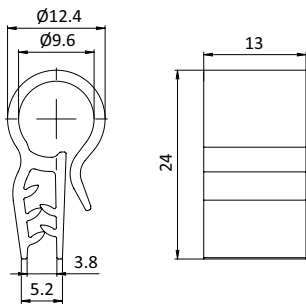

Lattice Box Clip for Visual Pocket
 Gitterbox-Clip für Sichttasche

Weight [g]
 Gewicht [g]

Part #
 Teil-Nr.

2.0

02011E03

PLASTIC PIN FOR VISUAL POCKET

KUNSTSTOFFPIEKSER FÜR SICHTTASCHE

<p>Model For attaching on cartons</p> <p>Description For quick pinning of attached visual pockets on cartons and other outer packaging made of foil or textile</p> <p>Material Plastic PP</p> <p>Color Black</p> <p>Pack Quantity 50 pieces</p> <p>Tip Compatible attached visual pockets see 02011A5LH15, 02011A4PH15 and 02011A1/3H15</p>	<p>Ausführung zum Befestigen an Kartonagen</p> <p>Beschreibung zum schnellen Anbringen von Anhängesichttaschen an Kartonagen und anderen Umverpackungen aus Folie oder Textil</p> <p>Material Kunststoff PP</p> <p>Farbe schwarz</p> <p>Liefereinheit 50 Stück</p> <p>Hinweis passende Anhängesichttaschen siehe 02011A5LH15, 02011A4PH15 und 02011A1/3H15</p>
---	--

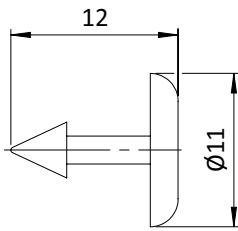

Plastic Pin for Visual Pocket
 Kunststoffpiekser für Sichttasche

Weight [g]
 Gewicht [g]

0.3

Part #
 Teil-Nr.

02011E04



PLASTIC TIE FOR VISUAL POCKET

KUNSTSTOFFBINDER FÜR SICHTTASCHE

<p>Model For binding to pipes and struts</p> <p>Description To bind and unbind attachable visual pockets easily to pipes, cables profiles etc.</p> <p>Material Plastic PE</p> <p>Color Red</p> <p>Pack Quantity 50 pieces</p> <p>Tip Compatible attached visual pockets see 02011A5LH15, 02011A4PH15 and 02011A1/3H15</p>	<p>Ausführung zum Anbinden an Leitungen und Streben</p> <p>Beschreibung zum einfachen Anbinden und wieder Lösen von Anhängesichttaschen an Rohre, Kabel, Profile etc.</p> <p>Material Kunststoff PE</p> <p>Farbe rot</p> <p>Liefeinheit 50 Stück</p> <p>Hinweis passende Anhängesichttaschen siehe 02011A5LH15, 02011A4PH15 und 02011A1/3H15</p>
---	--

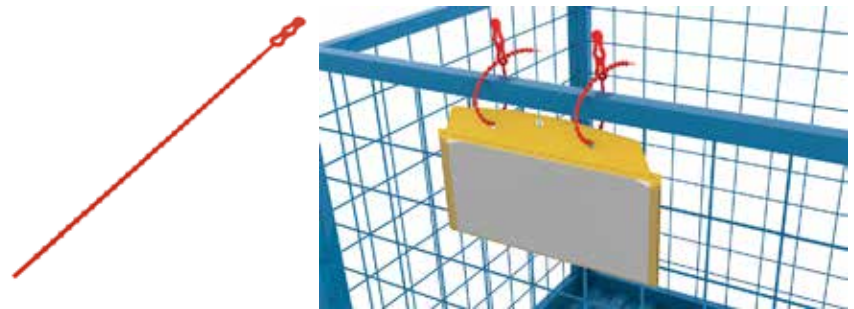
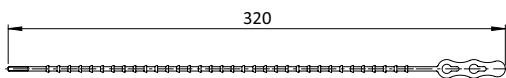

Plastic Tie for Visual Pocket
 Kunststoffbinder für Sichttasche

Weight [g]
 Gewicht [g]

Part #
 Teil-Nr.

2.5

02011E05

simply
practical

FATH®
COMPONENTS



KANBAN LABEL HOLDERS AND ENVELOPES KANBAN-ETIKETTENHALTER UND HÜLLEN

REUSABLE / MULTI-USE
WIEDERVERWENDBAR / MULTI-USE

IDENTIFY STORAGE CONTAINERS QUICKLY AND EASILY WITH FATH'S KANBAN LABEL HOLDERS AND ENVELOPES

LAGERBEHÄLTER SCHNELL UND FLEXIBEL KENNZEICHNEN MIT DEN FATH KANBAN-ETIKETTENHALTERN UND HÜLLEN

Magnetic, self-adhesive or for hanging over

Made of transparent, hard-wearing plastic, FATH's KANBAN label holders are available in magnetic, self-adhesive and hang-over versions, all of which are available in different formats. This allows you to label almost any load carrier, container or lattice box with little effort. The transparent plastic allows scanners to read the inserted documents without difficulty.

KANBAN label holders for instant identification of containers

- Self-adhesive
- Magnetic
- For hanging over
- KANBAN clip document holder with extremely strong clamping ability
- KANBAN label holder as per VDA standard
- Scanner readable

- **STRONG CLAMPING ABILITY**
- **FLEXIBLE FASTENING**

Selbstklebend, magnetisch oder zum Überhängen

Die FATH KANBAN-Etikettenhalter aus transparentem strapazierfähigem Kunststoff sind in den Varianten selbstklebend, magnetisch und zum Überhängen erhältlich – jeweils in unterschiedlichen Formaten. Damit können Sie nahezu alle Ladungsträger und Behälter sowie Gitterboxen unkompliziert kennzeichnen. Der Klar-sicht-Kunststoff ermöglicht das problemlose Einlesen der eingesteckten Belege mit dem Scanner.

KANBAN-Etikettenhalter für die blitzschnelle Kennzeichnung von Behältern

- Selbstklebend
- Magnetisch
- Zum Überhängen
- Clip-Dokumentenhalter mit besonders starker Klemmwirkung
- KANBAN-Etikettenhalter nach VDA-Norm
- Scannerlesbar

- **STARKE KLEMMWIRKUNG**
- **FLEXIBLE BEFESTIGUNG**

LEAN 4.0 AND PVC-FREE: EFFECTIVE CONTAINER IDENTIFICATION AND GREATER SUSTAINABILITY LEAN 4.0 UND VERZICHT AUF PVC: EFFEKTIVE BEHÄLTERKENNZEICHNUNG UND MEHR NACHHALTIGKEIT

The FATH KANBAN label holders are part of the PVC-free LEAN product family of FATH – products which allow you to design your production and logistics processes to be more efficient and leaner while helping to protect the environment at the same time. Instead of the problematic PVC material, plastics with extremely high strengths are used as well as a proportion of recycling material. LEAN products are UV-resistant, extremely durable and free from harmful substances.

Die FATH KANBAN-Etikettenhalter sind Teil der PVC-freien LEAN-Produktreihe von FATH – Produkte, mit denen Sie Ihre Produktions- und Logistikprozesse effizienter und schlanker gestalten können und zugleich einen Beitrag zum Umweltschutz leisten. Statt des problematischen Werkstoffs PVC werden Kunststoffe mit extrem hohen Festigkeiten eingesetzt, die aus einem Anteil von mindestens 40% an Recyclingmaterial bestehen. Die LEAN Produkte sind UV-beständig, äußerst langlebig und frei von gesundheitsgefährdenden Substanzen.

FATH'S KANBAN LABEL HOLDERS VERSIONS AND ATTACHMENT OPTIONS VARIANTEN UND ANBRINGUNGSMÖGLICHKEITEN DER FATH KANBAN-ETIKETTENHALTER



Large label holders – self-adhesive or magnetic

The self-adhesive KANBAN label holders are easily affixed to load carriers and remain attached to the object. They are suitable for labeling containers such as Euro boxes and SLCs. Documents can be replaced at any time as required – they can be inserted and removed in an instant thanks to the front foil's slanted edge. The self-adhesive KANBAN label holders are unique due to their reusability and offer flexibility never seen before. The adhesive adheres to glass, plastics, metal and all smooth surfaces.

With stable magnetic stripes attached to the back the magnetic version is suitable for metal containers and many other ferrous surfaces.



Große Etikettenhalter – selbstklebend oder magnetisch

Die selbstklebenden KANBAN-Etikettenhalter werden einfach auf den Ladungsträger aufgeklebt und verbleiben am Objekt. Sie eignen sich für die Kennzeichnung von Behältern wie KLT, Euroboxen etc. Die Belege können jederzeit nach Bedarf ausgetauscht werden – durch die abgeschrägte Kante der Vorderfolie sind das Einstecken und die Entnahme mit einem Handgriff erledigt. Die selbstklebenden KANBAN-Etikettenhalter zeichnen sich durch die einzigartige Funktion der Wiederverwendbarkeit aus und bieten eine bisher unbekannte Flexibilität. Der Kleber haftet auf Kunststoffen, Metall, Glas sowie allen glatten Flächen.

Die magnetische Variante mit rückseitig angebrachtem, stabilem Magnetstreifen eignet sich für Metallbehälter und viele weitere eisenhaltige Untergründe.



KANBAN label holders – for hanging over

Overhanging KANBAN label holders are fabricated in a single piece and are simply placed on the container edge. They can be removed again at any time. Due to its standardized dimensions, this version offers an excellent clamping ability and the containers remain stackable without any limitations. It offers a practical solution for labeling Euro boxes, plastic crates, etc. which need to be cleaned frequently, for example.

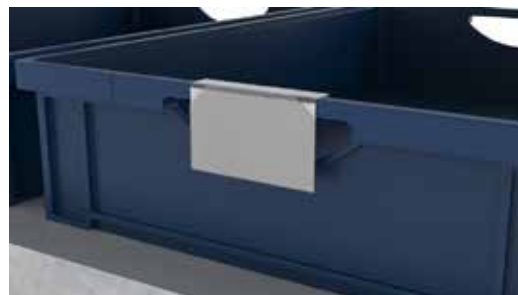

KANBAN-Etikettenhalter – zum Überhängen

Die KANBAN-Etikettenhalter zum Überhängen sind in einem Stück gearbeitet und werden einfach auf den Behälterrand gesteckt. Sie können jederzeit wieder abgenommen werden. Durch das genormte Maß bietet diese Variante eine gute Klemmwirkung und die Behälter bleiben ohne Einschränkung stapelbar. Eine praktische Lösung für die Kennzeichnung von Euroboxen, Kunststoffkisten etc., die z.B. häufig gereinigt werden müssen.



Small KANBAN label holders – self-adhesive with clip function and very strong clamping ability

The practical KANBAN clip document holders need to be affixed just once and are suitable for all containers with a non-laminating surface as well as for pallet feet. Insert documents such as material cards or item information cards into the label holders and you instantly have a clear identification of the materials. The KANBAN Clip document holder can be affixed to the inside of the container when necessary in the case of grab containers and semi-open front storage containers. Since re-labeling can be completed in seconds, KANBAN clip document holders are the perfect solution for frequent document changes. **FATH's** KANBAN clip document holders offer an extra advantage: Thanks to its particularly strong clamping ability, this document holder is also excellent for thick Kanban cards.

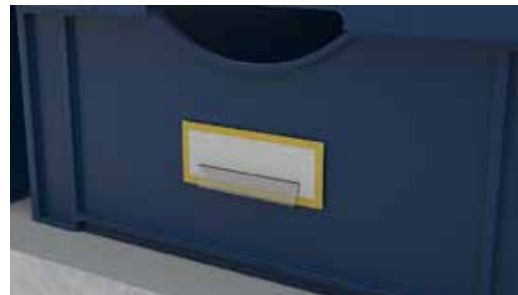

Kleine KANBAN-Etikettenhalter – selbstklebend mit Clip-Funktion und sehr hoher Klemmwirkung

Die praktischen kleinen KANBAN-Etikettenhalter werden einmalig aufgeklebt und eignen sich sowohl für alle Behälter mit tragendem Untergrund als auch für Paletten-FüÙe. Belege wie Materialkarten, Artikelinfos, Etikettentaschen etc. einstecken – fertig ist die klare Kennzeichnung. Bei Greifbehältern und Sichtlagerkästen kann der KANBAN-Etikettenhalter einfach in den Behälter geklebt werden. Da die Umetikettierung in Sekundenschnelle erledigt ist, sind die KANBAN-Clip Dokumentenhalter die perfekte Lösung bei häufigem Belegwechsel. Der Extra-Vorteil der **FATH** KANBAN-Clip Dokumentenhalter: Durch die besonders starke Klemmwirkung eignet sich dieser Beleghalter auch für dicke KANBAN-Karten.



KANBAN envelopes as per VDA standard – open at the top or side

FATH's KANBAN envelopes are extremely easy to use – simply insert or remove document in an instant. They comply with VDA standard 4902 and can be instantly inserted into the pre-assembled bracket on containers, such as SLCs. Ideally suited for production time cycles. Documents or cardboard inserts are protected against dirt and moisture in the **FATH's** KANBAN envelope version with an opening at the side. Documents remain legible even in production environments containing humid or oily air where processes such as turning, milling, grinding, or drilling take place.



KANBAN Hüllen nach VDA-Norm – oben oder seitlich geöffnet

Die **FATH** KANBAN Hüllen sind extrem schnell bestückbar – Beleg einfach mit einem Handgriff oben einstecken oder herausnehmen. Sie entsprechen der VDA-Norm 4902 und können blitzschnell in die vorgefertigte Halterung am Behältnis, wie KLT-Behältern, eingeschoben werden. Ideal geeignet für getaktete Produktionszeiten! Bei der seitlich geöffneten Variante der **FATH** KANBAN Hüllen sind Belege bzw. Kartoneinlagen zuverlässig vor Verschmutzung und Feuchtigkeit geschützt. Auch in Produktionsumgebungen mit feuchter oder ölhaltiger Luft, z.B. durch Drehen, Fräsen, Schleifen oder Bohren, bleiben die Belege lesbar.

Visual Management *Visual Management*

Container Labelings *Behälterkennzeichnungen*

KANBAN Label Holders and Envelopes *KANBAN-Etikettenhalter und Hüllen*

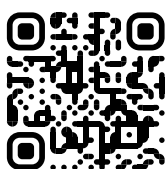

You would like to know more about
the FATH KANBAN Label Holders and
Envelopes?

label-holder.fath24.com

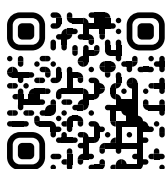

Sie möchten die FATH KANBAN-
Etikettenhalter und Hüllen besser
kennen lernen?

etikettenhalter.fath24.de

TOP OPEN KANBAN ENVELOPE 200 X 67 - 7.9" X 2.6"

OBEN OFFENE KANBAN HÜLLE 200 X 67

Model	Top open	Ausführung	oben offen
Description	Strong and durable envelope for inserting in SLC boxes (small load carrier), Euro containers, Kanban boards etc.; Protects Kanban cards from dirt and abrasion; Tear-resistant and stretchable transparent foil with restoring capacity, scanner-compatible	Beschreibung	belastbare und langlebige Hülle zum Einstecken in KLT-Boxen (Kleinladungsträger), Euro-Behälter, Kanban-Boards etc.; schützt Kanban-Karten vor Verschmutzung und Abnutzung; reißfeste und dehnbare Sichtfolie mit Rückstellvermögen, scannertauglich
Material	Plastic PVC	Material	Kunststoff PVC
Color	Transparent, yellow, red, blue, green, gray, black, white	Farbe	transparent, gelb, rot, blau, grün, grau, schwarz, weiß
Pack Quantity	50 pieces	Liefereinheit	50 Stück

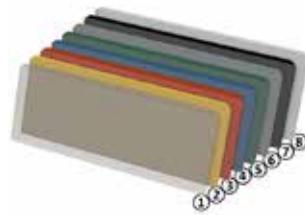
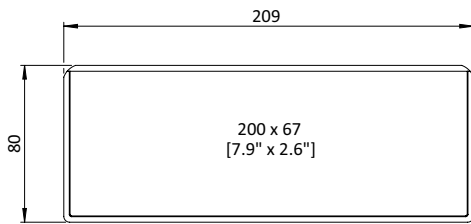
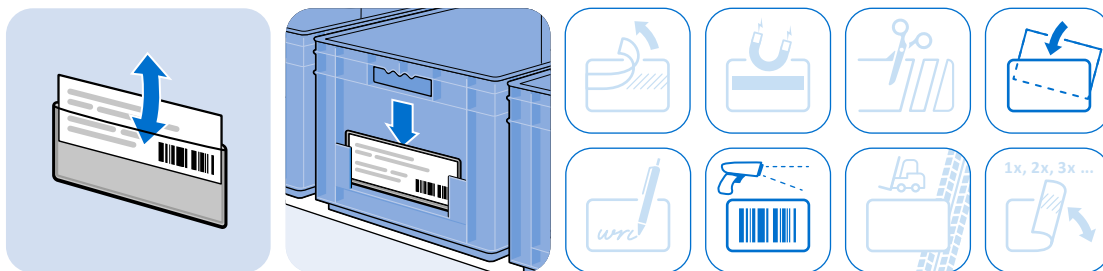

Fig. Abb.	Top Open KANBAN Envelope 200 x 67 - 7.9" x 2.6" Oben offene KANBAN Hülle 200 x 67	Color Farbe	Weight [g] Gewicht [g]	Part # Teil-Nr.
①		Transparent <i>transparent</i>	14.3	02013T6701
②		Yellow ≈ RAL 1018 <i>gelb</i>	14.3	02013T6715
③		Red ≈ RAL 3020 <i>rot</i>	14.3	02013T6731
④		Blue ≈ RAL 5017 <i>blau</i>	14.3	02013T6755
⑤		Green ≈ RAL 6016 <i>grün</i>	14.3	02013T6763
⑥		Gray ≈ RAL 7045 <i>grau</i>	14.3	02013T6775
⑦		Black <i>schwarz</i>	14.3	02013T6791
⑧		White ≈ RAL 9003 <i>weiß</i>	14.3	02013T6793



TOP OPEN KANBAN ENVELOPE 200 X 85 - 7.9" X 3.4"

OBEN OFFENE KANBAN HÜLLE 200 X 85

Model	Top open	Ausführung	oben offen
Description	Strong and durable envelope for inserting in SLC boxes (small load carrier), Euro containers, Kanban boards etc.; Protects Kanban cards from dirt and abrasion; Tear-resistant and stretchable transparent foil with restoring capacity, scanner-compatible	Beschreibung	belastbare und langlebige Hülle zum Einstecken in KLT-Boxen (Kleinladungsträger), Euro-Behälter, Kanban-Boards etc.; schützt Kanban-Karten vor Verschmutzung und Abnutzung; reißfeste und dehnbare Sichtfolie mit Rückstellvermögen, scannertauglich
Material	Plastic PVC	Material	Kunststoff PVC
Color	Transparent, yellow, red, blue, green, gray, black, white	Farbe	transparent, gelb, rot, blau, grün, grau, schwarz, weiß
Pack Quantity	50 pieces	Liefereinheit	50 Stück

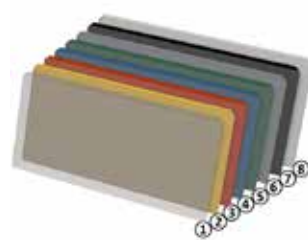
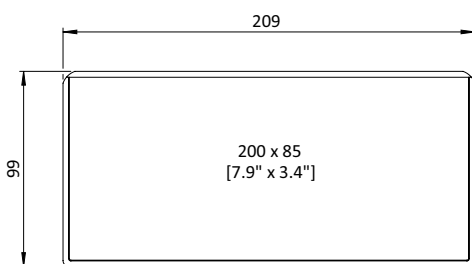
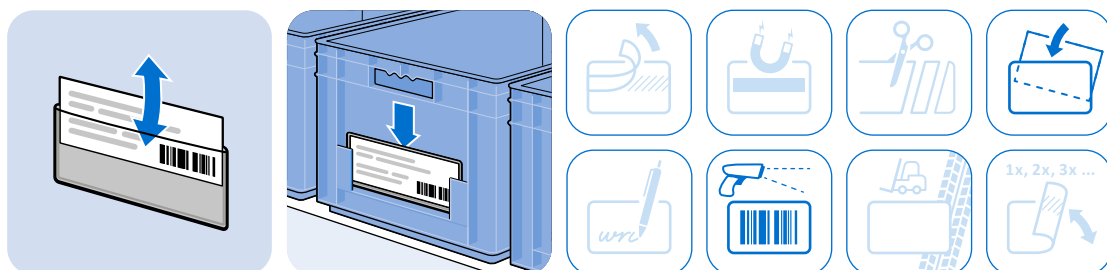

Fig. Abb.	Top Open KANBAN Envelope 200 x 85 - 7.9" x 3.4" Oben offene KANBAN Hülle 200 x 85	Color Farbe	Weight [g] Gewicht [g]	Part # Teil-Nr.
①		Transparent transparent	15.1	02013T8501
②		Yellow ≈ RAL 1018 gelb	15.1	02013T8515
③		Red ≈ RAL 3020 rot	15.1	02013T8531
④		Blue ≈ RAL 5017 blau	15.1	02013T8555
⑤		Green ≈ RAL 6016 grün	15.1	02013T8563
⑥		Gray ≈ RAL 7045 grau	15.1	02013T8575
⑦		Black schwarz	15.1	02013T8591
⑧		White ≈ RAL 9003 weiß	15.1	02013T8593



TOP OPEN KANBAN ENVELOPE 200 X 135 - 7.9" X 5.3"

OBEN OFFENE KANBAN HÜLLE 200 X 135

Model	Top open	Ausführung	oben offen
Description	Strong and durable envelope for inserting in SLC boxes (small load carrier), Euro containers, Kanban boards etc.; Protects Kanban cards from dirt and abrasion; Tear-resistant and stretchable transparent foil with restoring capacity, scanner-compatible	Beschreibung	belastbare und langlebige Hülle zum Einstecken in KLT-Boxen (Kleinladungsträger), Euro-Behälter, Kanban-Boards etc.; schützt Kanban-Karten vor Verschmutzung und Abnutzung; reißfeste und dehnbare Sichtfolie mit Rückstellvermögen, scannertauglich
Material	Plastic PVC	Material	Kunststoff PVC
Color	Transparent, yellow, red, blue, green, gray, black, white	Farbe	transparent, gelb, rot, blau, grün, grau, schwarz, weiß
Pack Quantity	50 pieces	Liefereinheit	50 Stück

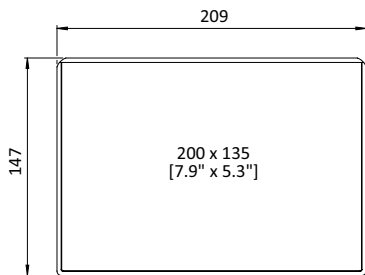
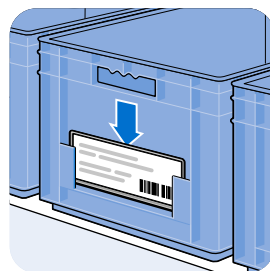
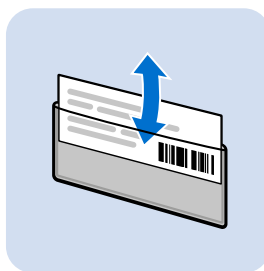

Fig. Abb.	Top Open KANBAN Envelope 200 x 135 - 7.9" x 5.3" Oben offene KANBAN Hülle 200 x 135	Color Farbe	Weight [g] Gewicht [g]	Part # Teil-Nr.
①		Transparent transparent	22.6	02013T13501
②		Yellow ≈ RAL 1018 gelb	22.6	02013T13515
③		Red ≈ RAL 3020 rot	22.6	02013T13531
④		Blue ≈ RAL 5017 blau	22.6	02013T13555
⑤		Green ≈ RAL 6016 grün	22.6	02013T13563
⑥		Gray ≈ RAL 7045 grau	22.6	02013T13575
⑦		Black schwarz	22.6	02013T13591
⑧		White ≈ RAL 9003 weiß	22.6	02013T13593



SIDE OPEN KANBAN ENVELOPE 200 X 67 - 7.9" X 2.6"

SEITLICH OFFENE KANBAN HÜLLE 200 X 67

Model	Side open	Ausführung	seitlich offen
Description	Strong and durable envelope for inserting in SLC boxes (small load carrier), Euro containers, Kanban boards etc.; Protects Kanban cards from dirt and abrasion; Tear-resistant and stretchable transparent foil with restoring capacity, scanner-compatible	Beschreibung	belastbare und langlebige Hülle zum Einstecken in KLT-Boxen (Kleinladungsträger), Euro-Behälter, Kanban-Boards etc.; schützt Kanban-Karten vor Verschmutzung und Abnutzung; reißfeste und dehnbare Sichtfolie mit Rückstellvermögen, scannertauglich
Material	Plastic PVC	Material	Kunststoff PVC
Color	Transparent, yellow, red, blue, green, gray, black, white	Farbe	transparent, gelb, rot, blau, grün, grau, schwarz, weiß
Pack Quantity	50 pieces	Liefereinheit	50 Stück

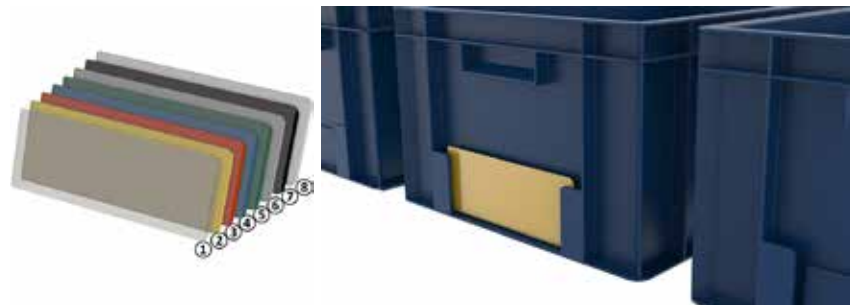
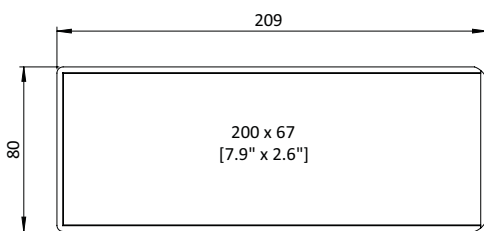
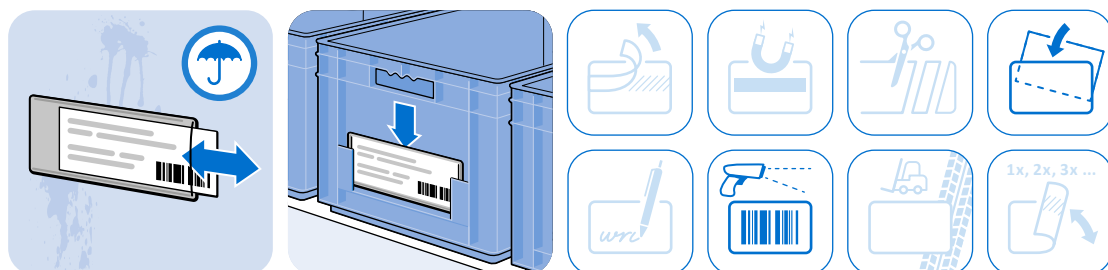

Fig. Abb.	Side Open KANBAN Envelope 200 x 67 - 7.9" x 2.6" Seitlich offene KANBAN Hülle 200 x 67	Color Farbe	Weight [g] Gewicht [g]	Part # Teil-Nr.
①		Transparent <i>transparent</i>	14.5	02013S6701
②		Yellow ≈ RAL 1018 <i>gelb</i>	14.5	02013S6715
③		Red ≈ RAL 3020 <i>rot</i>	14.5	02013S6731
④		Blue ≈ RAL 5017 <i>blau</i>	14.5	02013S6755
⑤		Green ≈ RAL 6016 <i>grün</i>	14.5	02013S6763
⑥		Gray ≈ RAL 7045 <i>grau</i>	14.5	02013S6775
⑦		Black <i>schwarz</i>	14.5	02013S6791
⑧		White ≈ RAL 9003 <i>weiß</i>	14.5	02013S6793



SIDE OPEN KANBAN ENVELOPE 200 X 85 - 7.9" X 3.4"

SEITLICH OFFENE KANBAN HÜLLE 200 X 85

Model	Side open	Ausführung	seitlich offen
Description	Strong and durable envelope for inserting in SLC boxes (small load carrier), Euro containers, Kanban boards etc.; Protects Kanban cards from dirt and abrasion; Tear-resistant and stretchable transparent foil with restoring capacity, scanner-compatible	Beschreibung	belastbare und langlebige Hülle zum Einstecken in KLT-Boxen (Kleinladungsträger), Euro-Behälter, Kanban-Boards etc.; schützt Kanban-Karten vor Verschmutzung und Abnutzung; reißfeste und dehnbare Sichtfolie mit Rückstellvermögen, scannertauglich
Material	Plastic PVC	Material	Kunststoff PVC
Color	Transparent, yellow, red, blue, green, gray, black, white	Farbe	transparent, gelb, rot, blau, grün, grau, schwarz, weiß
Pack Quantity	50 pieces	Liefereinheit	50 Stück

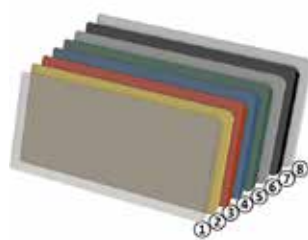
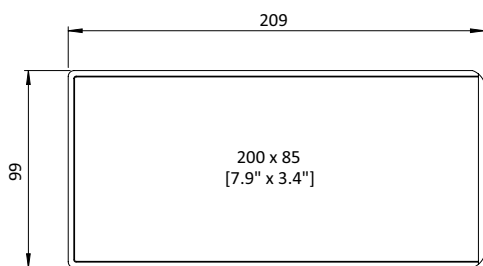
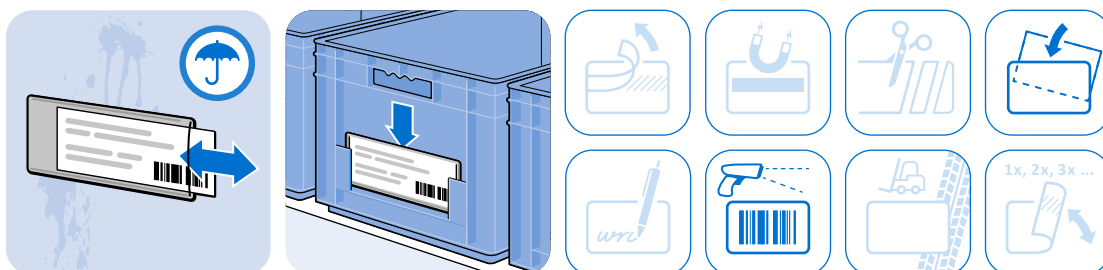

Fig. Abb.	Side Open KANBAN Envelope 200 x 85 - 7.9" x 3.4" Seitlich offene KANBAN Hülle 200 x 85	Color Farbe	Weight [g] Gewicht [g]	Part # Teil-Nr.
①		Transparent transparent	15.3	02013S8501
②		Yellow ≈ RAL 1018 gelb	15.3	02013S8515
③		Red ≈ RAL 3020 rot	15.3	02013S8531
④		Blue ≈ RAL 5017 blau	15.3	02013S8555
⑤		Green ≈ RAL 6016 grün	15.3	02013S8563
⑥		Gray ≈ RAL 7045 grau	15.3	02013S8575
⑦		Black schwarz	15.3	02013S8591
⑧		White ≈ RAL 9003 weiß	15.3	02013S8593



SIDE OPEN KANBAN ENVELOPE 200 X 135 - 7.9" X 5.3" SEITLICH OFFENE KANBAN HÜLLE 200 X 135

Model	Side open	Ausführung	seitlich offen
Description	Strong and durable envelope for inserting in SLC boxes (small load carrier), Euro containers, Kanban boards etc.; Protects Kanban cards from dirt and abrasion; Tear-resistant and stretchable transparent foil with restoring capacity, scanner-compatible	Beschreibung	belastbare und langlebige Hülle zum Einstecken in KLT-Boxen (Kleinladungsträger), Euro-Behälter, Kanban-Boards etc.; schützt Kanban-Karten vor Verschmutzung und Abnutzung; reißfeste und dehnbare Sichtfolie mit Rückstellvermögen, scannertauglich
Material	Plastic PVC	Material	Kunststoff PVC
Color	Transparent, yellow, red, blue, green, gray, black, white	Farbe	transparent, gelb, rot, blau, grün, grau, schwarz, weiß
Pack Quantity	50 pieces	Liefereinheit	50 Stück

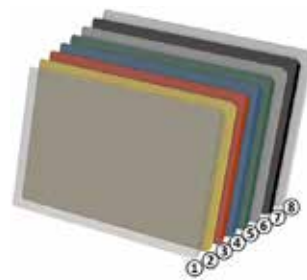
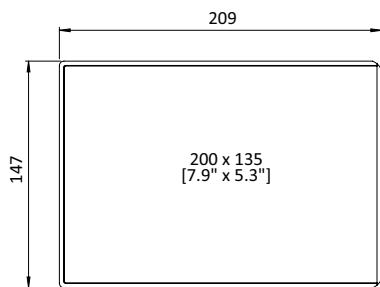
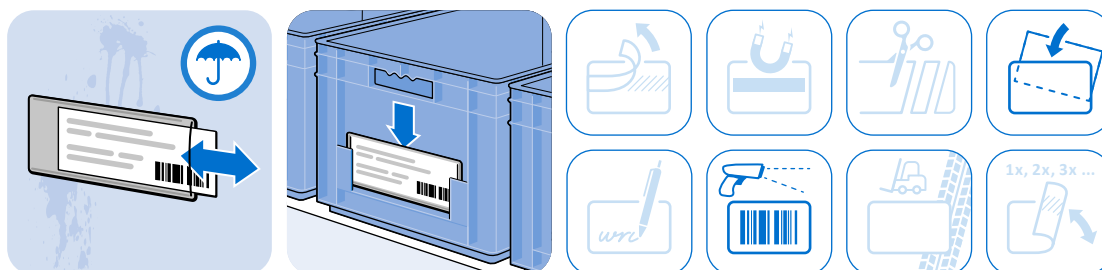
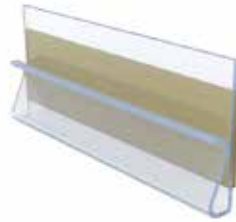
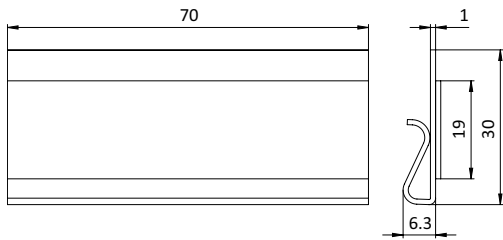

Fig. Abb.	Side Open KANBAN Envelope 200 x 135 - 7.9" x 5.3" Seitlich offene KANBAN Hülle 200 x 135	Color Farbe	Weight [g] Gewicht [g]	Part # Teil-Nr.
①		Transparent transparent	22.7	02013S13501
②		Yellow ≈ RAL 1018 gelb	22.7	02013S13515
③		Red ≈ RAL 3020 rot	22.7	02013S13531
④		Blue ≈ RAL 5017 blau	22.7	02013S13555
⑤		Green ≈ RAL 6016 grün	22.7	02013S13563
⑥		Gray ≈ RAL 7045 grau	22.7	02013S13575
⑦		Black schwarz	22.7	02013S13591
⑧		White ≈ RAL 9003 weiß	22.7	02013S13593



KANBAN CLIP DOCUMENT HOLDER 70 X 30 - 2.8" X 1.2" KANBAN-CLIP DOKUMENTENHALTER 70 X 30

Model	Self-adhesive	Ausführung	selbstklebend
Description	Universal clip to hold Kanban cards, label envelopes or documents, For adhesive bonding on various surfaces from plastic containers to wooden pallet feet, Usable for all common formats	Beschreibung	universeller Clip zur Aufnahme von Kanban-Karten, Etikettenhüllen oder Dokumenten, zum Ankleben auf vielen Untergründen von Kunststoffbehältern bis Holz-Palettenfüßen, nutzbar für alle gängigen Formaten
Material	Clip: Plastic PVC Adhesive strip: PE foam	Material	Clip: Kunststoff PVC Klebestreifen: PE-Schaumstoff
Color	Transparent	Farbe	transparent
Pack Quantity	100 pieces	Liefereinheit	100 Stück



KANBAN Clip Document Holder 70 x 30 - 2.8" x 1.2"
 KANBAN-Clip Dokumentenhalter 70 x 30

Weight [g]
 Gewicht [g]

Part #
 Teil-Nr.

	5.0	02012ASA
--	-----	----------



OVERHANGING KANBAN LABEL HOLDER

ÜBERHÄNGE-KANBAN-ETIKETTENHALTER

<p>Model PVC free, for overhanging on containers</p> <p>Description To hold Kanban cards or documents; For overhanging on small load carriers and other boxes, containers stay still stackable; Available in all common formats</p> <p>Material Label holder: Plastic, PVC-free</p> <p>Color Transparent</p> <p>Pack Quantity 10 pieces</p>	<p>Ausführung PVC-frei, zum Überhängen an Behältern</p> <p>Beschreibung zum Aufnehmen von Kanban-Karten oder Dokumenten; zum Überhängen an Kleinladungsträgern und anderen Behältern, Behälter bleiben stapelbar; erhältlich in allen gängigen Formaten</p> <p>Material Etikettenhalter: Kunststoff, PVC-frei</p> <p>Farbe transparent</p> <p>Liefereinheit 10 Stück</p>
--	---

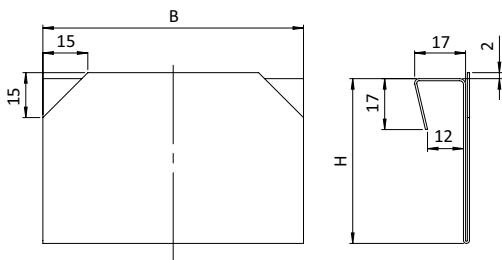

Overhanging KANBAN Label Holder <i>Überhänge-KANBAN-Etikettenhalter</i>	H [mm]	B [mm]	Weight [g] <i>Gewicht [g]</i>	Part # <i>Teil-Nr.</i>
	55	87	12.2	02012ECH
	78	110	20.5	02012A7H
	108	155	38.3	02012A6H
	153	215	72.4	02012A5H
	78	215	40.3	02012A1/4H

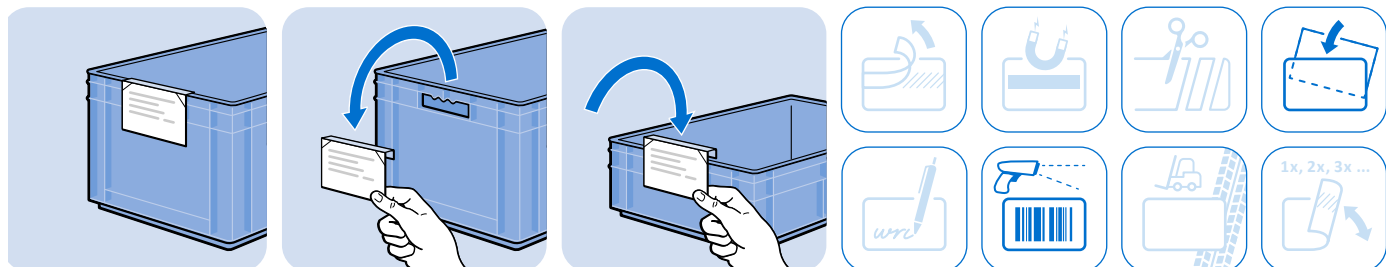

SELF-ADHESIVE KANBAN LABEL HOLDER

SELBSTKLEBENDE KANBAN-ETIKETTENHALTER

Model	PVC free, self-adhesive (multi-use)	Ausführung	PVC-frei, selbstklebend (multi-use)
Description	To hold Kanban cards or documents; For flexible adhesion even on uneven surfaces, removable without leaving any residue, reusable on supporting surfaces thanks to multi-use properties; Available in all common formats	Beschreibung	zum Aufnehmen von Kanban-Karten oder Dokumenten; zum flexiblen Ankleben auch auf unebenen Oberflächen, rückstandsfrei entfernbar, mehrfach wiederverwendbar auf tragenden Untergründen dank multi-use Eigenschaft; erhältlich in allen gängigen Formaten
Material	Label holder: Plastic, PVC-free Adhesive strip: PE foam, reusable	Material	Etikettenhalter: Kunststoff, PVC-frei Klebestreifen: PE-Schaumstoff, wiederverwendbar
Color	Transparent	Farbe	transparent
Pack Quantity	10 pieces	Liefereinheit	10 Stück

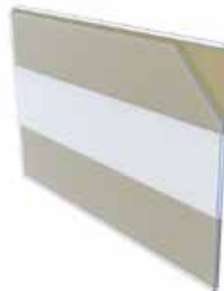
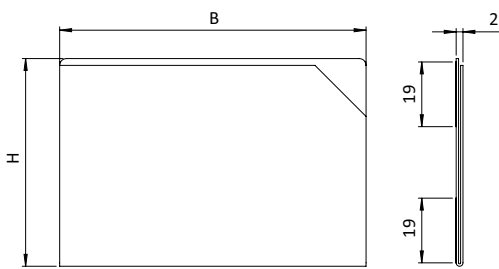

Self-adhesive KANBAN Label Holder Selbstklebende KANBAN-Etikettenhalter	H [mm]	B [mm]	Weight [g] Gewicht [g]	Part # Teil-Nr.
	61	90	10.6	02012ECA
	87	110	17.8	02012A7A
	117	158	35.1	02012A6A
	163	220	69.0	02012A5A
	92	220	37.9	02012A1/4A

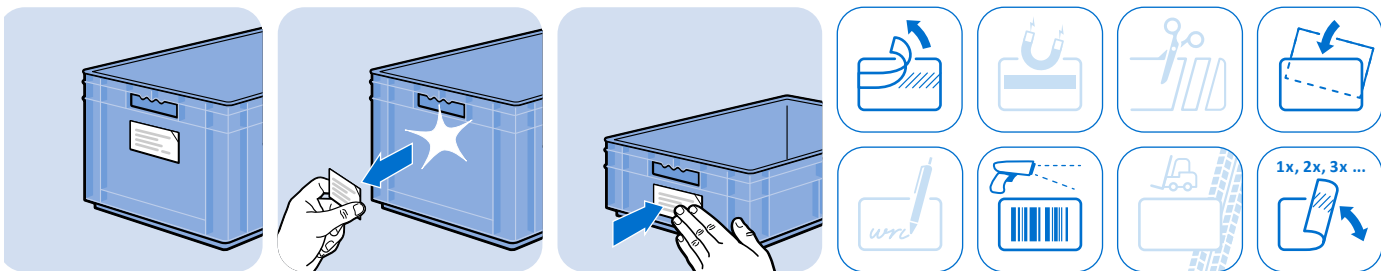

MAGNETIC KANBAN LABEL HOLDER

MAGNETISCHE KANBAN-ETIKETTENHALTER

Model	PVC free, magnetic	Ausführung	PVC-frei, magnetisch
Description	To hold Kanban cards or documents; For magnetic mounting on metallic surfaces; Available in all common formats	Beschreibung	zum Aufnehmen von Kanban-Karten oder Dokumenten; zur magnetischen Befestigung auf metallischen Oberflächen; erhältlich in allen gängigen Formaten
Material	Label holder: Plastic, PVC-free Magnetic strip	Material	Etikettenhalter: Kunststoff, PVC-frei Magnetstreifen
Color	Transparent	Farbe	transparent
Pack Quantity	10 pieces	Liefereinheit	10 Stück

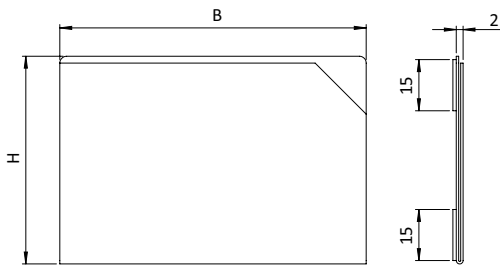

Magnetic KANBAN Label Holder Magnetische KANBAN-Etikettenhalter	H [mm]	B [mm]	Weight [g] Gewicht [g]	Part # Teil-Nr.
	61	90	30.0	02012ECM
	87	110	40.0	02012A7M
	117	158	67.0	02012A6M
	163	220	120.0	02012A5M
	92	220	88.0	02012A1/4M

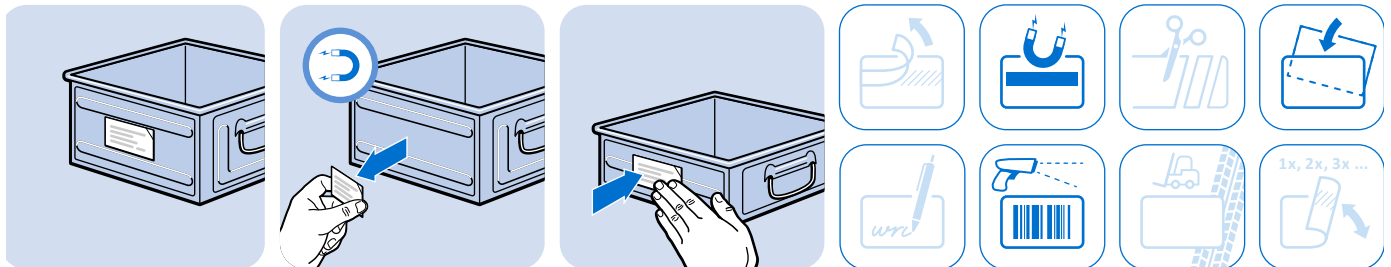

SHELF LABELINGS REGALKENNZEICHNUNGEN



Container Labelings
Behälterkennzeichnungen 1

**Shelf Labelings
Regalkennzeichnungen 2**

Floor Markings
Bodenmarkierungen 3

Stickers
Aufkleber 4

Inserting Systems
Einstecksysteme 5

Visual Boards
Visual Boards 6

MATERIAL FLOW MATERIALFLUSS

Material Transport
Materialtransport 7

Material Supply
Materialbereitstellung 8

	Self-adhesive Label Holder 20 - 0.8" <i>Selbstklebender Einsteckträger 20</i>	47		2-sides Open Self-adhesive Label Envelope 37 - 1.5" <i>Zweiseitig offene selbstklebende Etikettenhülle 37</i>	57
	Self-adhesive Label Holder 27 - 1.06" <i>Selbstklebender Einsteckträger 27</i>	48		2-sides Open Self-adhesive Label Envelope 50 - 2" <i>Zweiseitig offene selbstklebende Etikettenhülle 50</i>	58
	Self-adhesive Label Holder 38 - 1.5" <i>Selbstklebender Einsteckträger 38</i>	49		2-sides Open Magnetic Label Envelope 37 - 1.5" <i>Zweiseitig offene magnetische Etikettenhülle 37</i>	59
	Self-adhesive Label Holder 47 - 1.85" <i>Selbstklebender Einsteckträger 47</i>	50		2-sides Open Magnetic Label Envelope 50 - 2" <i>Zweiseitig offene magnetische Etikettenhülle 50</i>	60
	Self-adhesive Label Holder 67 - 2.64" <i>Selbstklebender Einsteckträger 67</i>	51		Top Open Self-adhesive Label Envelope 37 - 1.5" <i>Oben offene selbstklebende Etikettenhülle 37</i>	61
	Magnetic Label Holder 20 - 0.8" <i>Magnetischer Einsteckträger 20</i>	52		Top Open Self-adhesive Label Envelope 50 - 2" <i>Oben offene selbstklebende Etikettenhülle 50</i>	62
	Magnetic Label Holder 27 - 1.06" <i>Magnetischer Einsteckträger 27</i>	53		Top Open Magnetic Label Envelope 37 - 1.5" <i>Oben offene magnetische Etikettenhülle 37</i>	63
	Magnetic Label Holder 38 - 1.5" <i>Magnetischer Einsteckträger 38</i>	54		Top Open Magnetic Label Envelope 50 - 2" <i>Oben offene magnetische Etikettenhülle 50</i>	64
	Magnetic Label Holder 47 - 1.85" <i>Magnetischer Einsteckträger 47</i>	55		Side Open Self-adhesive Label Envelope 60 - 2.4" <i>Seitlich offene selbstklebende Etikettenhülle 60</i>	65
	Magnetic Label Holder 67 - 2.64" <i>Magnetischer Einsteckträger 67</i>	56		Side Open Magnetic Label Envelope 60 - 2.4" <i>Seitlich offene magnetische Etikettenhülle 60</i>	66

simply
practical

FATH®
COMPONENTS



SHELF LABELINGS REGALKENNZEICHNUNGEN

PVC-FREE AND REUSABLE
WIEDERVERWENDBAR
UND PVC-FREI

LEAN AND SUSTAINABLE: LABEL SHELVES ACCURATELY WITH THE REUSABLE FATH SHELF LABELINGS LEAN UND NACHHALTIG: REGALE PRÄZISE BESCHILDERN MIT DEN WIEDERVERWENDBAREN FATH REGALKENNZEICHNUNGEN

Reusable (multi-use) self-adhesive or magnetically attached – either way scanner ready

The shelf label holders are available as reusable (multi-use) self-adhesive or magnetic, either with or without color index and in numerous formats for labeling all standard rack cross beams. Inserted documents are held securely on all types of shelf racks, can be read by a scanner and are easy to change.

- Reusable (multi-use) self-adhesive or magnetic
- PVC-free material
- Many different formats
- With and without color index
- Scanner readable

Shelf Label Envelopes consist of a colored film on the back and a transparent front side. The colored wraparound edge makes it very easy to differentiate between product groups or material types with strong visual effect. Good handling and secure hold apply here too.

The shelf labelings are available in the standard widths and heights to fit your shelving.

- REUSABLE
- PVC-FREE LABEL HOLDER

Selbstklebend (multi-use) oder magnetisch – scannertauglich

Die Regaleinsteckträger sind in den Varianten selbstklebend (multi-use) und magnetisch erhältlich, jeweils mit oder ohne Farbindex und in zahlreichen Formaten für die Beschilderung aller gängigen Regaltraversen. Eingesteckte Belege finden an allen Regaltypen sicheren Halt, bleiben scannerlesbar und sind einfach zu wechseln.

- Selbstklebend (multi-use) oder magnetisch
- PVC-freies Material
- Viele unterschiedliche Formate
- Mit und ohne Farbindex
- Scannerlesbar

Regaletikettenhüllen bestehen aus einer farbigen Folie auf der Rückseite und einer transparenten Vorderseite. Der farblich umlaufende Rand macht eine Unterscheidung z.B. nach Artikelgruppen oder Materialarten durch den starken visuellen Effekt besonders einfach. Auch hier gilt: gute Handhabung und sicherer Halt.

Die Regalkennzeichnungen sind in den gängigen Höhenmaßen und Breiten erhältlich, passend zu Ihrem Regal.

- WIEDERVERWENDBAR
- PVC-FREIE EINSTECKTRÄGER



MAGNETIC: INSERT SHELF LABELINGS IN ONE STEP MAGNETISCH: REGALKENNZEICHNUNGEN MIT EINEM GRIFF UMSTECKEN

The magnetic design of FATH Shelf Label Envelopes and Label Holders provide a strong grip on all ferrous surfaces. Once attached, the shelf labeling will remain in place, even withstanding strong vibrations, for example when storing goods with the forklift truck. If relabeling is required, the magnetic shelf labeling is simply removed and repositioned with one movement. The magnet is firmly bonded to the holder and guarantees stability and durability.

Die magnetische Ausführung der FATH Regaletikettenhüllen und Etikettenhalter bietet eine hohe Haftkraft auf metallischen Untergründen. Einmal angebracht, bleibt die Regalbeschilderung an Ort und Stelle und hält auch stärkeren Erschütterungen stand, etwa beim Einlagern mit dem Gabelstapler. Ist eine Umetikettierung nötig, wird die magnetische Regalkennzeichnung einfach abgenommen und mit einem Handgriff umplatziert. Der fest mit dem Halter verklebte Magnet gewährleistet Stabilität und Langlebigkeit.



UNIQUE WORLDWIDE: REUSABLE (MULTI-USE) SELF-ADHESIVE SHELF LABELINGS WELTWEIT EINZIGARTIG: SELBSTKLEBENDE REGALKENNZEICHNUNGEN ZUR MEHRFACHNUTZUNG

This is new: The **FATH** self-adhesive shelf labelings are reusable again and again, as the innovative adhesive retains its adhesive ability after being removed without leaving any residue behind. The special adhesive smooths unevenness and offers excellent instant adhesion on almost all load-bearing substrates. Simply peel off the backing of the double-sided adhesive tape, press on and it's done!

If the shelf needs to be relabeled, the labeling can simply be removed again. While conventional adhesives leave stubborn residues, which have to be removed laboriously, the new self-adhesive **FATH** products can be removed in one piece completely residue-free. The adhesive sticks to the shelf labeling and can be immediately reattached elsewhere multiple times.

This is lean and sustainable: the fast and flexible transfer of labels saves working time. The reusability also saves resources and reduces the amount of waste.

*Das ist neu: Die selbstklebenden **FATH** Regalkennzeichnungen sind vielfach wiederverwendbar, da der innovative Kleber auch nach dem Ablösen seine Haftfunktion behält und keine Rückstände hinterlässt. Der Spezialkleber gleicht Unebenheiten aus und bietet auf nahezu allen tragenden Untergründen eine hohe Soforthaftkraft. Einfach die Trennabdeckung des doppelseitigen Klebestreifens abziehen, andrücken, fertig!*

*Muss das Regal neu beschriftet werden, kann die Kennzeichnung einfach wieder abgelöst werden. Während herkömmliche Kleber dabei hartnäckige Kleberückstände hinterlassen, die mühsam entfernt werden müssen, sind die neuartigen selbstklebenden Produkte von **FATH** völlig rückstandsfrei und in einem Stück ablösbar. Der Kleber bleibt an der Regalkennzeichnung haften und kann mehrfach an anderer Stelle sofort wieder aufgeklebt werden.*

Das ist lean und nachhaltig: Das schnelle flexible Umsetzen der Kennzeichnung spart Arbeitszeit. Durch die Mehrfachverwendung werden zudem die Ressourcen geschont und die Abfallmenge wird verringert.

OPTIONAL: CARDBOARD INSERTS FOR LABEL PRINTING OPTIONAL: KARTONEINLAGEN FÜR DEN ETIKETTENDRUCK

Placement of shelf labeling could not be easier with **FATH**: Sheets of cardboard in DIN A4 format are available for all sizes – with microperforation in every label size. The sheets are suitable for any standard printer. Fill in templates, separate and insert labels, attach shelf labels – and your shelves are labeled accurately.

*Auch die Bestückung der Regalkennzeichnung ist mit **FATH** denkbar einfach: Für alle Größen sind Kartonbögen im Format DIN A4 erhältlich – mit Mikroperforation in der jeweiligen Etikettengröße. Die Bögen eignen sich für jeden Standarddrucker. Druckvorlagen ausfüllen, Labels auseinandertrennen, einstecken, Regalkennzeichnungen anbringen – und Ihre Regale sind präzise beschildert.*

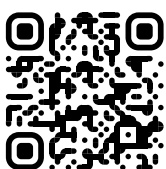

You would like to know more about the FATH Shelf Labelings?

shelf-labeling.fath24.com



Sie möchten die FATH Regalkennzeichnungen besser kennen lernen?

regalkennzeichnung.fath24.de

SELF-ADHESIVE LABEL HOLDER 20 - 0.8"

SELBSTKLEBENDER EINSTECKTRÄGER 20

<p>Model PVC free, self-adhesive (multi-use)</p> <p>Description To hold labels; For adhesion on shelves, removable without leaving any residue, reusable on supporting surfaces thanks to multi-use properties; Side and top open, scanner-compatible</p> <p>Material Label holder: Plastic, PVC free Adhesive strip: PE foam, reusable</p> <p>Color Transparent</p> <p>Pack Quantity 50 pieces</p>	<p>Ausführung PVC-frei, selbstklebend (multi-use)</p> <p>Beschreibung zur Aufnahme von Etiketten; zum Ankleben auf Regalen, rückstandsfrei entfernbar, mehrfach wiederverwendbar auf tragenden Untergründen dank multi-use Eigenschaft; seitlich und oben offen, scannerlesbar</p> <p>Material Einsteckträger: Kunststoff, PVC-frei Klebestreifen: PE-Schaumstoff, wiederverwendbar</p> <p>Farbe transparent</p> <p>Liefereinheit 50 Stück</p>
--	---



Self-adhesive Label Holder 20 - 0.8"
 Selbstklebender Einsteckträger 20

	L [mm]	Weight [g] Gewicht [g]	Part # Teil-Nr.
	75.0	2.3	02021H20075A01
	100.0	3.0	02021H20100A01
	150.0	4.6	02021H20150A01

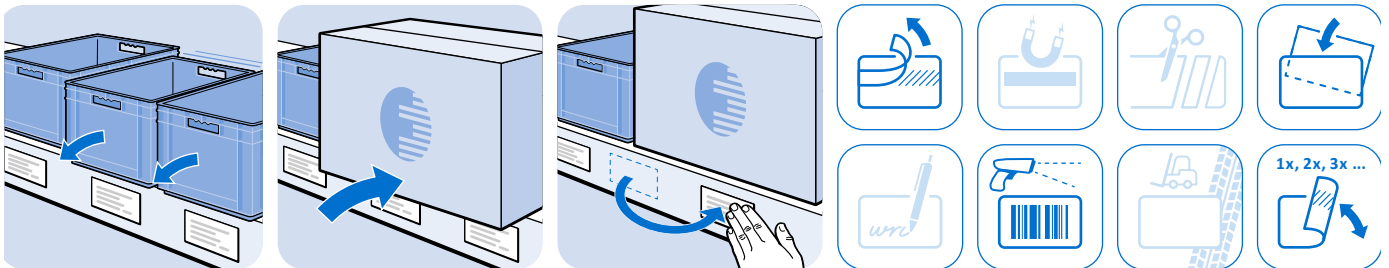

SELF-ADHESIVE LABEL HOLDER 27 - 1.06"

SELBSTKLEBENDER EINSTECKTRÄGER 27

<p>Model PVC free, self-adhesive (multi-use)</p> <p>Description To hold labels; For adhesion on shelves, removable without leaving any residue, reusable on supporting surfaces thanks to multi-use properties; Side and top open, scanner-compatible</p> <p>Material Label holder: Plastic, PVC free Adhesive strip: PE foam, reusable</p> <p>Color Transparent</p> <p>Pack Quantity 50 pieces</p>	<p>Ausführung PVC-frei, selbstklebend (multi-use)</p> <p>Beschreibung zur Aufnahme von Etiketten; zum Ankleben auf Regalen, rückstandsfrei entfernbar, mehrfach wiederverwendbar auf tragenden Untergründen dank multi-use Eigenschaft; seitlich und oben offen, scannerlesbar</p> <p>Material Einsteckträger: Kunststoff, PVC-frei Klebestreifen: PE-Schaumstoff, wiederverwendbar</p> <p>Farbe transparent</p> <p>Liefereinheit 50 Stück</p>
--	---

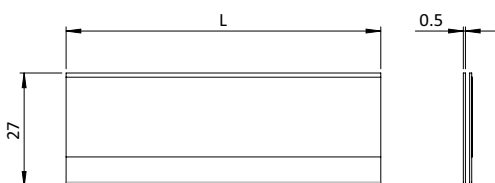

Self-adhesive Label Holder 27 - 1.06"
 Selbstklebender Einsteckträger 27

	L [mm]	Weight [g] Gewicht [g]	Part # Teil-Nr.
	75.0	3.0	02021H27075A01
	100.0	4.0	02021H27100A01
	150.0	7.0	02021H27150A01

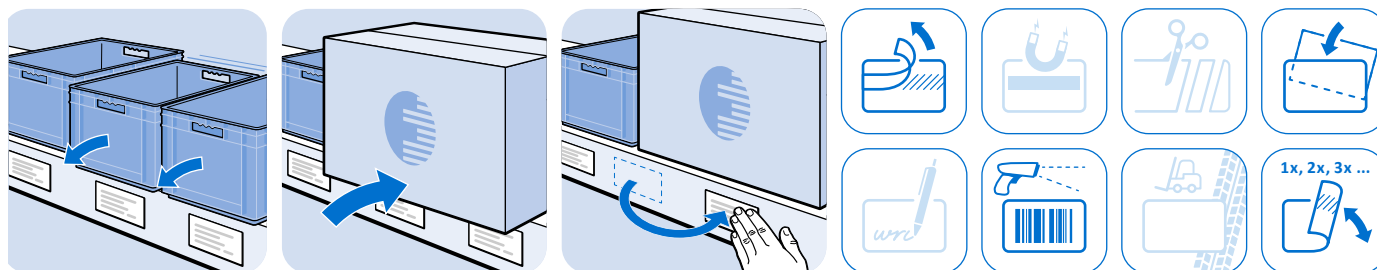

SELF-ADHESIVE LABEL HOLDER 38 - 1.5"

SELBSTKLEBENDER EINSTECKTRÄGER 38

<p>Model PVC free, self-adhesive (multi-use)</p> <p>Description To hold labels; For adhesion on shelves, removable without leaving any residue, reusable on supporting surfaces thanks to multi-use properties; Side and top open, scanner-compatible</p> <p>Material Label holder: Plastic, PVC free Adhesive strip: PE foam, reusable</p> <p>Color Transparent</p> <p>Pack Quantity 50 pieces</p>	<p>Ausführung PVC-frei, selbstklebend (multi-use)</p> <p>Beschreibung zur Aufnahme von Etiketten; zum Ankleben auf Regalen, rückstandsfrei entfernbar, mehrfach wiederverwendbar auf tragenden Untergründen dank multi-use Eigenschaft; seitlich und oben offen, scannerlesbar</p> <p>Material Einsteckträger: Kunststoff, PVC-frei Klebestreifen: PE-Schaumstoff, wiederverwendbar</p> <p>Farbe transparent</p> <p>Liefereinheit 50 Stück</p>
--	---

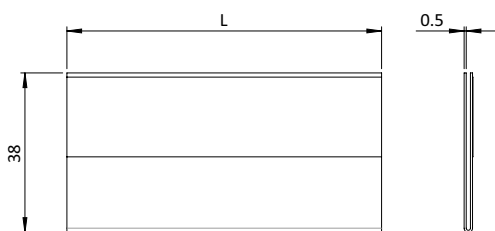

Self-adhesive Label Holder 38 - 1.5"
 Selbstklebender Einsteckträger 38

	L [mm]	Weight [g] Gewicht [g]	Part # Teil-Nr.
	75.0	5.0	02021H38075A01
	100.0	6.0	02021H38100A01
	150.0	9.0	02021H38150A01

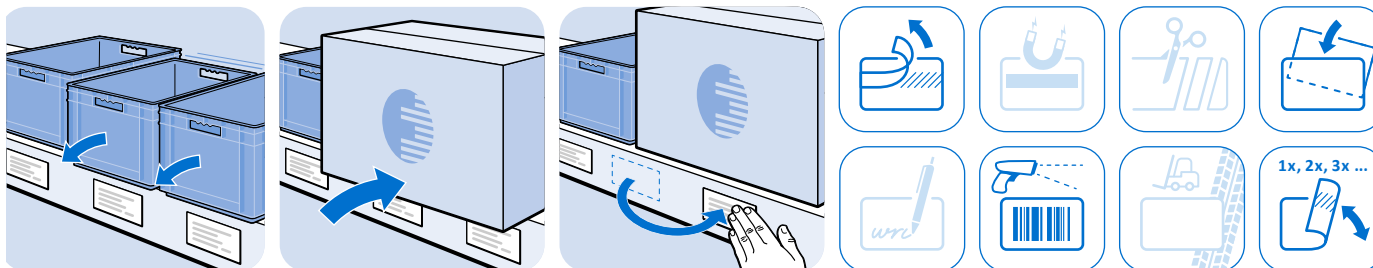

SELF-ADHESIVE LABEL HOLDER 47 - 1.85"

SELBSTKLEBENDER EINSTECKTRÄGER 47

<p>Model PVC free, self-adhesive (multi-use)</p> <p>Description To hold labels; For adhesion on shelves, removable without leaving any residue, reusable on supporting surfaces thanks to multi-use properties; Side and top open, scanner-compatible</p> <p>Material Label holder: Plastic, PVC free Adhesive strip: PE foam, reusable</p> <p>Color Transparent</p> <p>Pack Quantity 50 pieces</p>	<p>Ausführung PVC-frei, selbstklebend (multi-use)</p> <p>Beschreibung zur Aufnahme von Etiketten; zum Ankleben auf Regalen, rückstandsfrei entfernbar, mehrfach wiederverwendbar auf tragenden Untergründen dank multi-use Eigenschaft; seitlich und oben offen, scannerlesbar</p> <p>Material Einsteckträger: Kunststoff, PVC-frei Klebestreifen: PE-Schaumstoff, wiederverwendbar</p> <p>Farbe transparent</p> <p>Liefereinheit 50 Stück</p>
--	---

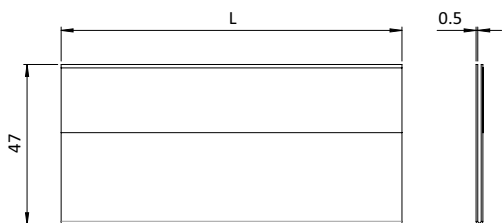

Self-adhesive Label Holder 47 - 1.85"
 Selbstklebender Einsteckträger 47

	L [mm]	Weight [g] Gewicht [g]	Part # Teil-Nr.
	100.0	7.0	02021H47100A01
	150.0	11.0	02021H47150A01

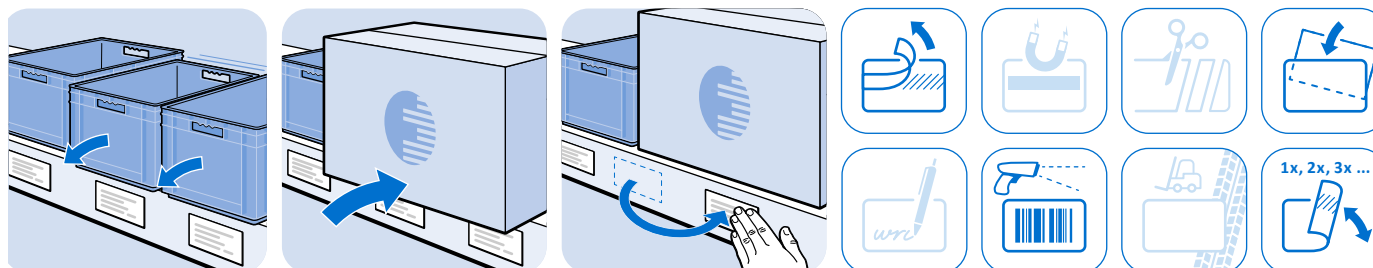

SELF-ADHESIVE LABEL HOLDER 67 - 2.64"

SELBSTKLEBENDER EINSTECKTRÄGER 67

<p>Model PVC free, self-adhesive (multi-use)</p> <p>Description To hold labels; For adhesion on shelves, removable without leaving any residue, reusable on supporting surfaces thanks to multi-use properties; Side and top open, scanner-compatible</p> <p>Material Label holder: Plastic, PVC free Adhesive strip: PE foam, reusable</p> <p>Color Transparent</p> <p>Pack Quantity 50 pieces</p>	<p>Ausführung PVC-frei, selbstklebend (multi-use)</p> <p>Beschreibung zur Aufnahme von Etiketten; zum Ankleben auf Regalen, rückstandsfrei entfernbar, mehrfach wiederverwendbar auf tragenden Untergründen dank multi-use Eigenschaft; seitlich und oben offen, scannerlesbar</p> <p>Material Einsteckträger: Kunststoff, PVC-frei Klebestreifen: PE-Schaumstoff, wiederverwendbar</p> <p>Farbe transparent</p> <p>Liefereinheit 50 Stück</p>
--	---

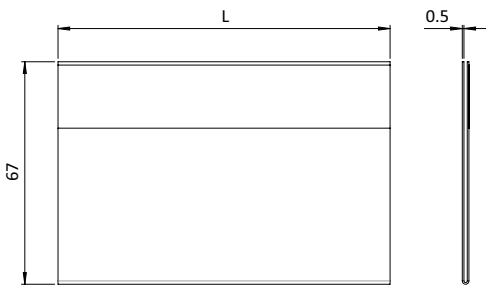

Self-adhesive Label Holder 67 - 2.64"
 Selbstklebender Einsteckträger 67

	L [mm]	Weight [g] Gewicht [g]	Part # Teil-Nr.
	100.0	10.0	02021H67100A01
	200.0	20.0	02021H67200A01

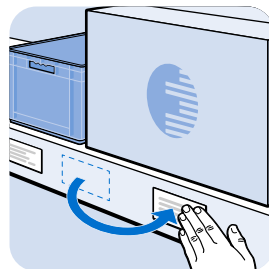
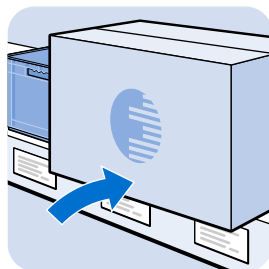
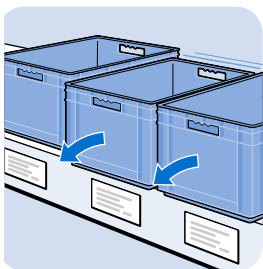

MAGNETIC LABEL HOLDER 20 - 0.8"

MAGNETISCHER EINSTECKTRÄGER 20

Model	PVC free, magnetic	Ausführung	PVC-frei, magnetisch
Description	To hold labels; For magnetic mounting on metallic surfaces, e.g. shelves; Side and top open, scanner-compatible	Beschreibung	zur Aufnahme von Etiketten; zur magnetischen Befestigung auf metallischen Oberflächen, z.B. Regalen; seitlich und oben offen, scannerlesbar
Material	Label holder: Plastic, PVC free Magnetic strip	Material	Einsteckträger: Kunststoff, PVC-frei Magnetstreifen
Color	Transparent	Farbe	transparent
Pack Quantity	50 pieces	Lieferinheit	50 Stück

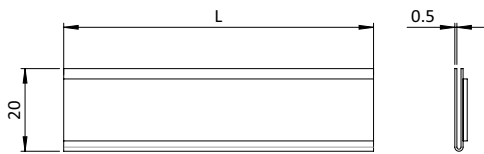

Magnetic Label Holder 20 - 0.8" Magnetischer Einsteckträger 20	L [mm]	Weight [g] Gewicht [g]	Part # Teil-Nr.
	75.0	11.0	02021H20075M01
	100.0	15.0	02021H20100M01
	150.0	22.0	02021H20150M01

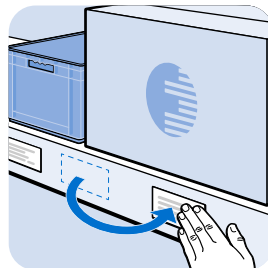
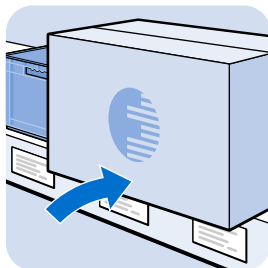
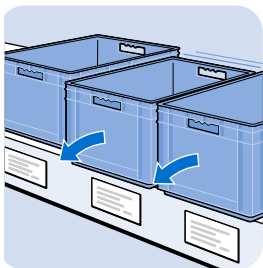

MAGNETIC LABEL HOLDER 27 - 1.06"

MAGNETISCHER EINSTECKTRÄGER 27

Model	PVC free, magnetic	Ausführung	PVC-frei, magnetisch
Description	To hold labels; For magnetic mounting on metallic surfaces, e.g. shelves; Side and top open, scanner-compatible	Beschreibung	zur Aufnahme von Etiketten; zur magnetischen Befestigung auf metallischen Oberflächen, z.B. Regalen; seitlich und oben offen, scannerlesbar
Material	Label holder: Plastic, PVC free Magnetic strip	Material	Einsteckträger: Kunststoff, PVC-frei Magnetstreifen
Color	Transparent	Farbe	transparent
Pack Quantity	50 pieces	Liefereinheit	50 Stück

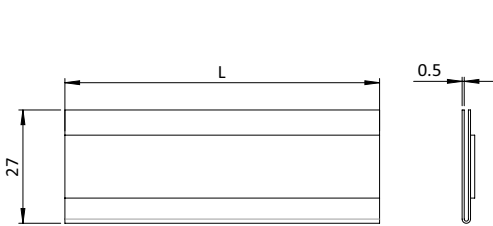

Magnetic Label Holder 27 - 1.06" Magnetischer Einsteckträger 27	L [mm]	Weight [g] Gewicht [g]	Part # Teil-Nr.
	75.0	12	02021H27075M01
	100.0	16.0	02021H27100M01
	150.0	24.0	02021H27150M01



MAGNETIC LABEL HOLDER 38 - 1.5"

MAGNETISCHER EINSTECKTRÄGER 38

Model	PVC free, magnetic	Ausführung	PVC-frei, magnetisch
Description	To hold labels; For magnetic mounting on metallic surfaces, e.g. shelves; Side and top open, scanner-compatible	Beschreibung	zur Aufnahme von Etiketten; zur magnetischen Befestigung auf metallischen Oberflächen, z.B. Regalen; seitlich und oben offen, scannerlesbar
Material	Label holder: Plastic, PVC free Magnetic strip	Material	Einsteckträger: Kunststoff, PVC-frei Magnetstreifen
Color	Transparent	Farbe	transparent
Pack Quantity	50 pieces	Lieferinheit	50 Stück



Magnetic Label Holder 38 - 1.5" Magnetischer Einsteckträger 38	L [mm]	Weight [g] Gewicht [g]	Part # Teil-Nr.
	75.0	13.0	02021H38075M01
	100.0	18.0	02021H38100M01
	150.0	26.0	02021H38150M01

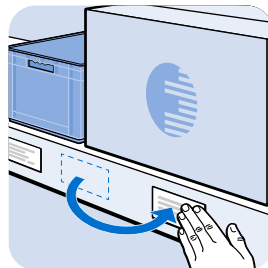
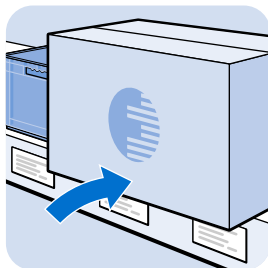
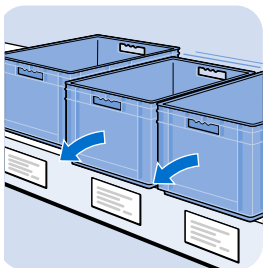

MAGNETIC LABEL HOLDER 47 - 1.85"

MAGNETISCHER EINSTECKTRÄGER 47

<p>Model PVC free, magnetic</p> <p>Description To hold labels; For magnetic mounting on metallic surfaces, e.g. shelves; Side and top open, scanner-compatible</p> <p>Material Label holder: Plastic, PVC free Magnetic strip</p> <p>Color Transparent</p> <p>Pack Quantity 50 pieces</p>	<p>Ausführung PVC-frei, magnetisch</p> <p>Beschreibung zur Aufnahme von Etiketten; zur magnetischen Befestigung auf metallischen Oberflächen, z.B. Regalen; seitlich und oben offen, scannerlesbar</p> <p>Material Einsteckträger: Kunststoff, PVC-frei Magnetstreifen</p> <p>Farbe transparent</p> <p>Liefereinheit 50 Stück</p>
--	--

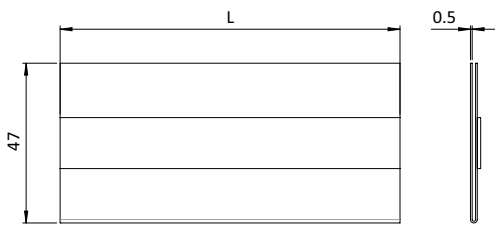

Magnetic Label Holder 47 - 1.85"
 Magnetischer Einsteckträger 47

	L [mm]	Weight [g] Gewicht [g]	Part # Teil-Nr.
	100.0	19.0	02021H47100M01
	150.0	28.0	02021H47150M01

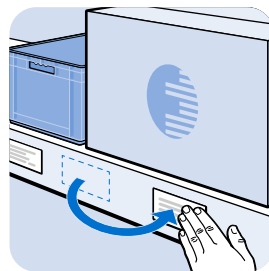
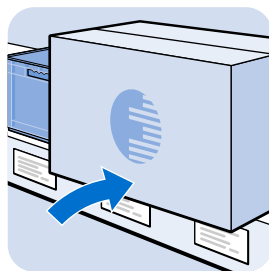
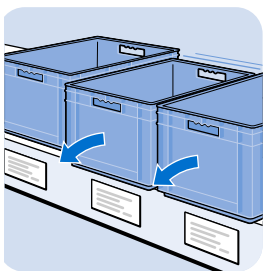

MAGNETIC LABEL HOLDER 67 - 2.64"

MAGNETISCHER EINSTECKTRÄGER 67

Model	PVC free, magnetic	Ausführung	PVC-frei, magnetisch
Description	To hold labels; For magnetic mounting on metallic surfaces, e.g. shelves; Side and top open, scanner-compatible	Beschreibung	zur Aufnahme von Etiketten; zur magnetischen Befestigung auf metallischen Oberflächen, z.B. Regalen; seitlich und oben offen, scannerlesbar
Material	Label holder: Plastic, PVC free Magnetic strip	Material	Einsteckträger: Kunststoff, PVC-frei Magnetstreifen
Color	Transparent	Farbe	transparent
Pack Quantity	50 pieces	Lieferinheit	50 Stück

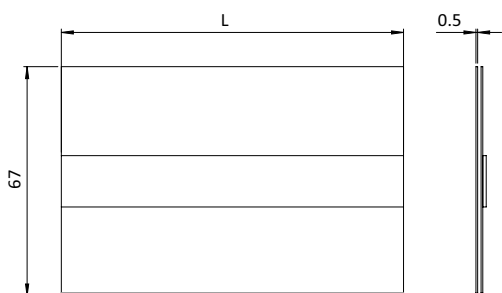

Magnetic Label Holder 67 - 2.64"
 Magnetischer Einsteckträger 67

	L [mm]	Weight [g] Gewicht [g]	Part # Teil-Nr.
	100.0	22.0	02021H67100M01
	200.0	43.0	02021H67200M01

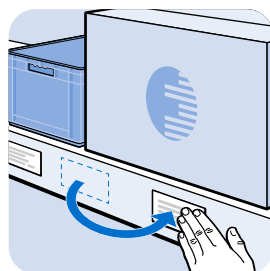
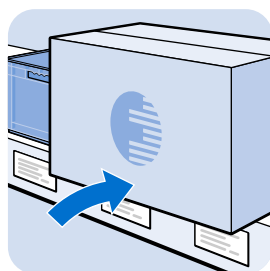
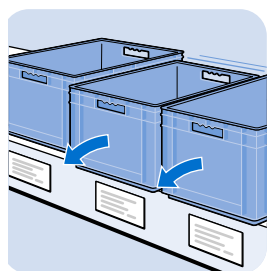

2-SIDES OPEN SELF-ADHESIVE LABEL ENVELOPE 37 - 1.5"

ZWEISEITIG OFFENE SELBSTKLEBENDE ETIKETTENHÜLLE 37

Model	Self-adhesive (multi-use)	Ausführung	<i>selbstklebend (multi-use)</i>
Description	To hold labels; For flexible adhesion on shelves even on uneven surfaces, removable without leaving any residue, reusable on supporting surfaces thanks to multi-use properties; Top and right side open for quick label change, tear-resistant and stretchable transparent foil with restoring capacity, scanner-compatible	Beschreibung	<i>zur Aufnahme von Etiketten; zum flexiblen Ankleben auf Regalen auch auf unebenen Oberflächen, rückstandsfrei entfernbar, mehrfach wiederverwendbar auf tragenden Untergründen dank multi-use Eigenschaft; oben und seitlich rechts offen für den schnellen Wechsel von Etiketten, reißfeste und dehnbare Sichtfolie mit Rückstellvermögen, scannertauglich</i>
Material	Label envelope: Plastic, PVC Adhesive strip: PE foam, reusable	Material	<i>Etikettenhülle: Kunststoff, PVC Klebestreifen: PE-Schaumstoff, wiederverwendbar</i>
Color	Yellow, red, blue, green, black, white	Farbe	<i>gelb, rot, blau, grün, schwarz, weiß</i>
Pack Quantity	50 pieces	Liefereinheit	<i>50 Stück</i>

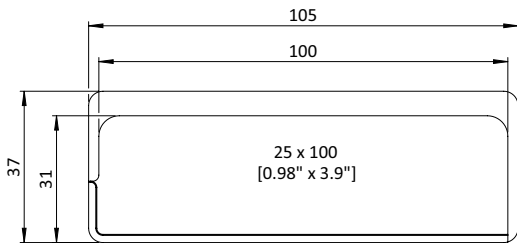
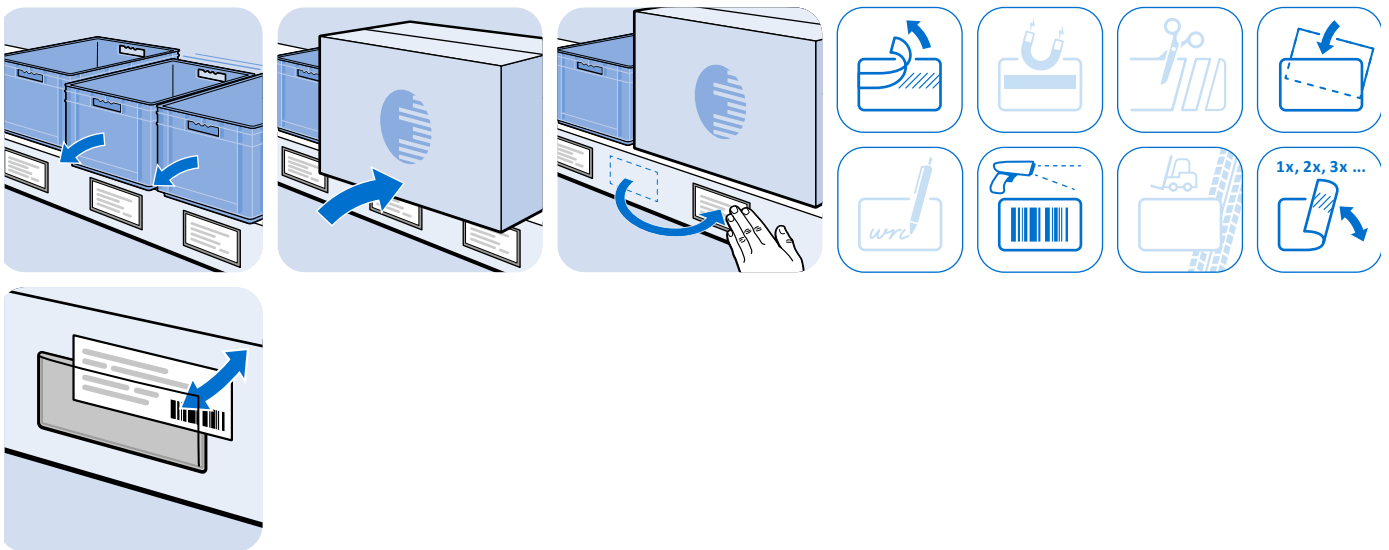

Fig. 2-sides Open Self-adhesive Label Envelope 37 - 1.5"
 Abb. *Zweiseitig offene selbstklebende Etikettenhülle 37*

Color Farbe	Weight [g] Gewicht [g]	Part # Teil-Nr.
① Yellow ≈ RAL 1018 <i>gelb</i>	2.0	02021E37105LA15
② Red ≈ RAL 3020 <i>rot</i>	2.0	02021E37105LA31
③ Blue ≈ RAL 5017 <i>blau</i>	2.0	02021E37105LA55
④ Green ≈ RAL 6016 <i>grün</i>	2.0	02021E37105LA63
⑤ Black <i>schwarz</i>	2.0	02021E37105LA91
⑥ White ≈ RAL 9003 <i>weiß</i>	2.0	02021E37105LA93



2-SIDES OPEN SELF-ADHESIVE LABEL ENVELOPE 50 - 2"

ZWEISEITIG OFFENE SELBSTKLEBENDE ETIKETTENHÜLLE 50

Model	Self-adhesive (multi-use)	Ausführung	selbstklebend (multi-use)
Description	To hold labels; For flexible adhesion on shelves even on uneven surfaces, removable without leaving any residue, reusable on supporting surfaces thanks to multi-use properties; Top and right side open for quick label change, tear-resistant and stretchable transparent foil with restoring capacity, scanner-compatible	Beschreibung	zur Aufnahme von Etiketten; zum flexiblen Ankleben auf Regalen auch auf unebenen Oberflächen, rückstandsfrei entfernbar, mehrfach wiederverwendbar auf tragenden Untergründen dank multi-use Eigenschaft; oben und seitlich rechts offen für den schnellen Wechsel von Etiketten, reißfeste und dehnbare Sichtfolie mit Rückstellvermögen, scannertauglich
Material	Label envelope: Plastic, PVC Adhesive strip: PE foam, reusable	Material	Etikettenhülle: Kunststoff, PVC Klebestreifen: PE-Schaumstoff, wiederverwendbar
Color	Yellow, red, blue, green, black, white	Farbe	gelb, rot, blau, grün, schwarz, weiß
Pack Quantity	50 pieces	Lieferereinheit	50 Stück

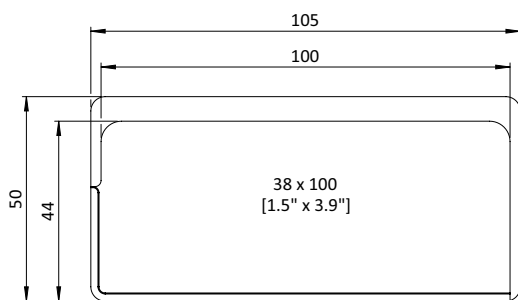
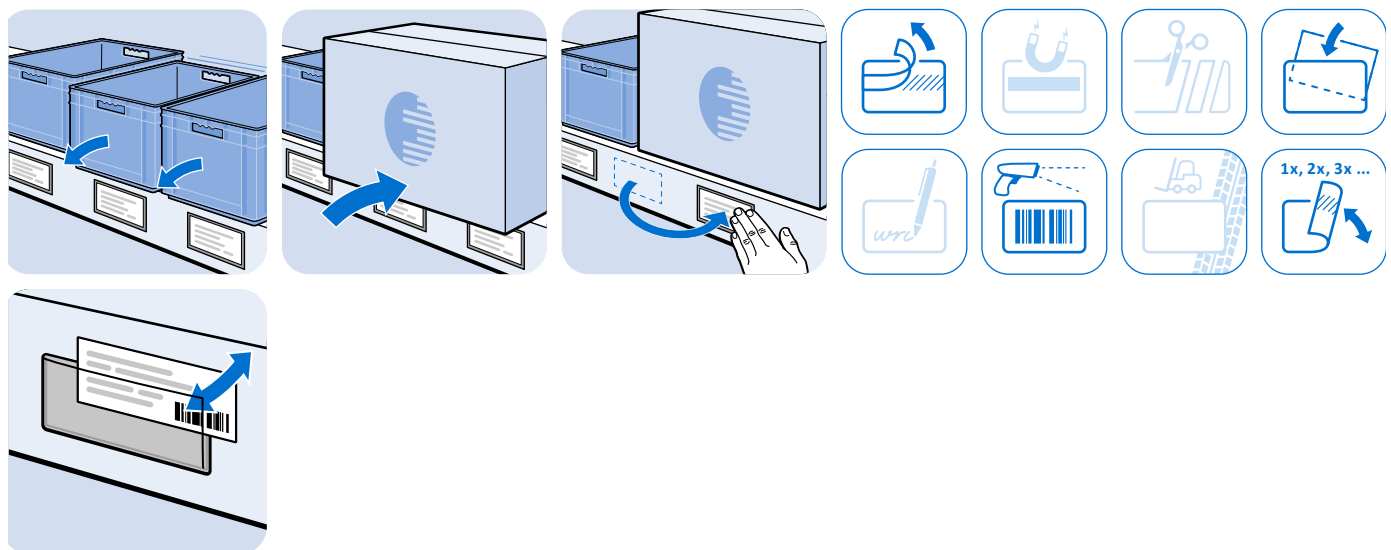

Fig. Abb.	2-sides Open Self-adhesive Label Envelope 50 - 2" Zweiseitig offene selbstklebende Etikettenhülle 50	Color Farbe	Weight [g] Gewicht [g]	Part # Teil-Nr.
①		Yellow ≈ RAL 1018 <i>gelb</i>	2.6	02021E50105LA15
②		Red ≈ RAL 3020 <i>rot</i>	2.6	02021E50105LA31
③		Blue ≈ RAL 5017 <i>blau</i>	2.6	02021E50105LA55
④		Green ≈ RAL 6016 <i>grün</i>	2.6	02021E50105LA63
⑤		Black <i>schwarz</i>	2.6	02021E50105LA91
⑥		White ≈ RAL 9003 <i>weiß</i>	2.6	02021E50105LA93



2-SIDES OPEN MAGNETIC LABEL ENVELOPE 37 - 1.5"

ZWEISEITIG OFFENE MAGNETISCHE ETIKETTENHÜLLE 37

Model	Magnetic	Ausführung	magnetisch
Description	To hold labels; For magnetic mounting on metallic surfaces, e.g. shelves; Top and right side open for quick label change, tear-resistant and stretchable transparent foil with restoring capacity, scanner-compatible	Beschreibung	zur Aufnahme von Etiketten; zur magnetischen Befestigung auf metallischen Oberflächen, z.B. Regalen; oben und seitlich rechts offen für den schnellen Wechsel von Etiketten, reißfeste und dehnbare Sichtfolie mit Rückstellvermögen, scannertauglich
Material	Label envelope: Plastic, PVC Magnetic strip	Material	Etikettenhülle: Kunststoff, PVC Magnetstreifen
Color	Yellow, red, blue, green, black, white	Farbe	gelb, rot, blau, grün, schwarz, weiß
Pack Quantity	50 pieces	Liefereinheit	50 Stück

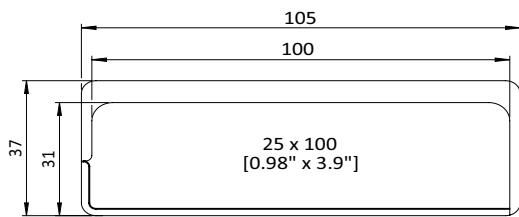
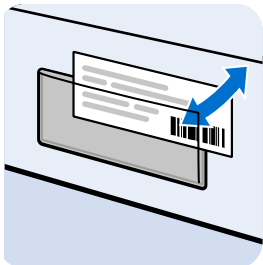
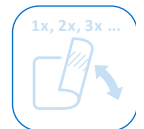
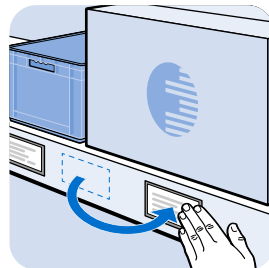
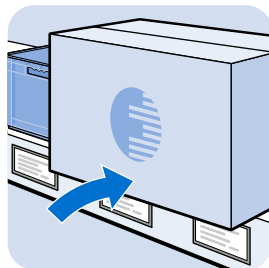
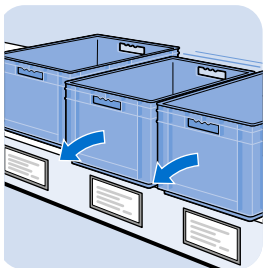

Fig. Abb.	2-sides Open Magnetic Label Envelope 37 - 1.5" Zweiseitig offene magnetische Etikettenhülle 37	Color Farbe	Weight [g] Gewicht [g]	Part # Teil-Nr.
①		Yellow ≈ RAL 1018 <i>gelb</i>	13.6	02021E37105LM15
②		Red ≈ RAL 3020 <i>rot</i>	13.6	02021E37105LM31
③		Blue ≈ RAL 5017 <i>blau</i>	13.6	02021E37105LM55
④		Green ≈ RAL 6016 <i>grün</i>	13.6	02021E37105LM63
⑤		Black <i>schwarz</i>	13.6	02021E37105LM91
⑥		White ≈ RAL 9003 <i>weiß</i>	13.6	02021E37105LM93



2-SIDES OPEN MAGNETIC LABEL ENVELOPE 50 - 2"

ZWEISEITIG OFFENE MAGNETISCHE ETIKETTENHÜLLE 50

Model	Magnetic	Ausführung	magnetisch
Description	To hold labels; For magnetic mounting on metallic surfaces, e.g. shelves; Top and right side open for quick label change, tear-resistant and stretchable transparent foil with restoring capacity, scanner-compatible	Beschreibung	zur Aufnahme von Etiketten; zur magnetischen Befestigung auf metallischen Oberflächen, z.B. Regalen; oben und seitlich rechts offen für den schnellen Wechsel von Etiketten, reißfeste und dehnbare Sichtfolie mit Rückstellvermögen, scannertauglich
Material	Label envelope: Plastic, PVC Magnetic strip	Material	Etikettenhülle: Kunststoff, PVC Magnetstreifen
Color	Yellow, red, blue, green, black, white	Farbe	gelb, rot, blau, grün, schwarz, weiß
Pack Quantity	50 pieces	Lieferinheit	50 Stück

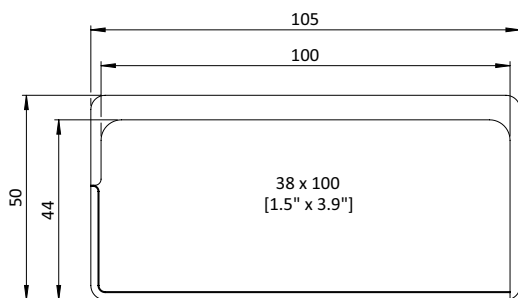
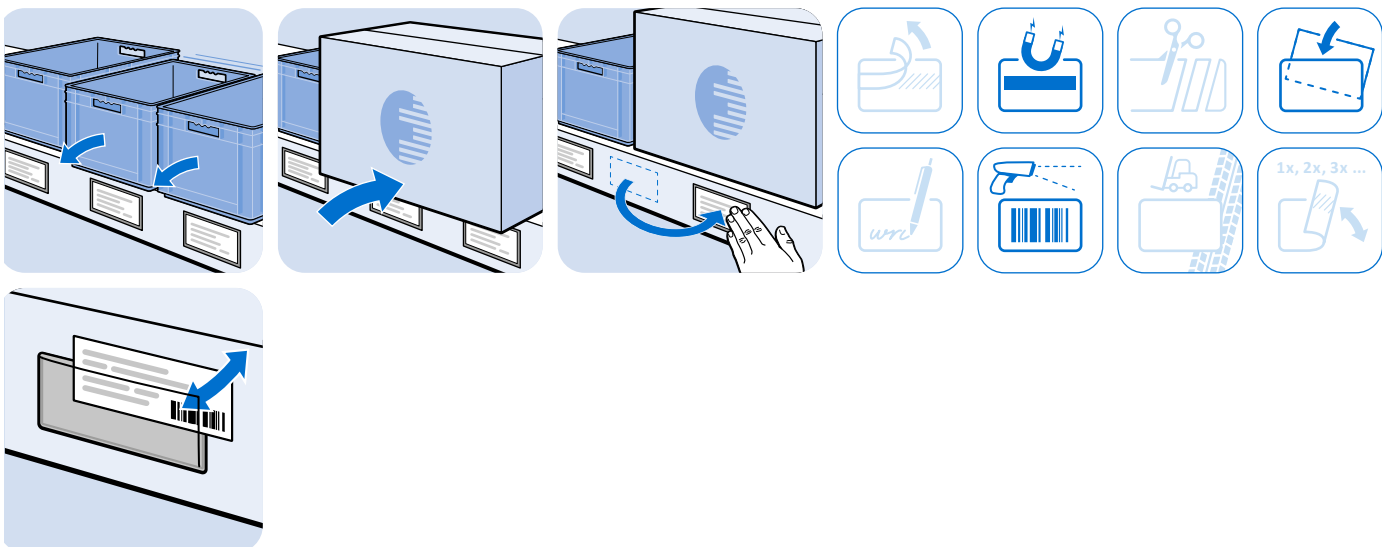

Fig. Abb.	2-sides Open Magnetic Label Envelope 50 - 2" Zweiseitig offene magnetische Etikettenhülle 50	Color Farbe	Weight [g] Gewicht [g]	Part # Teil-Nr.
①		Yellow ≈ RAL 1018 <i>gelb</i>	14.2	02021E50105LM15
②		Red ≈ RAL 3020 <i>rot</i>	14.2	02021E50105LM31
③		Blue ≈ RAL 5017 <i>blau</i>	14.2	02021E50105LM55
④		Green ≈ RAL 6016 <i>grün</i>	14.2	02021E50105LM63
⑤		Black <i>schwarz</i>	14.2	02021E50105LM91
⑥		White ≈ RAL 9003 <i>weiß</i>	14.2	02021E50105LM93



TOP OPEN SELF-ADHESIVE LABEL ENVELOPE 37 - 1.5"

OBEN OFFENE SELBSTKLEBENDE ETIKETTENHÜLLE 37

Model	Self-adhesive (multi-use)	Ausführung	selbstklebend (multi-use)
Description	To hold labels; For flexible adhesion on shelves even on uneven surfaces, removable without leaving any residue, reusable on supporting surfaces thanks to multi-use properties; Top open, tear-resistant and stretchable transparent foil with restoring capacity, scanner-compatible	Beschreibung	zur Aufnahme von Etiketten; zum flexiblen Ankleben auf Regalen auch auf unebenen Oberflächen, rückstandsfrei entfernbar, mehrfach wiederverwendbar auf tragenden Untergründen dank multi-use Eigenschaft; oben offen, reißfeste und dehnbare Sichtfolie mit Rückstellvermögen, scannertauglich
Material	Label envelope: Plastic, PVC Adhesive strip: PE foam, reusable	Material	Etikettenhülle: Kunststoff, PVC Klebestreifen: PE-Schaumstoff, wiederverwendbar
Color	Yellow, red, blue, green, black, white	Farbe	gelb, rot, blau, grün, schwarz, weiß
Pack Quantity	50 pieces	Liefeinheit	50 Stück

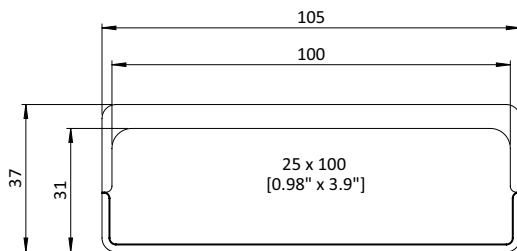
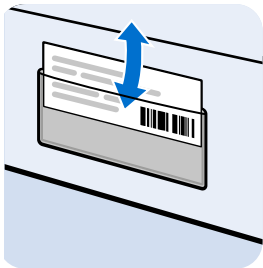
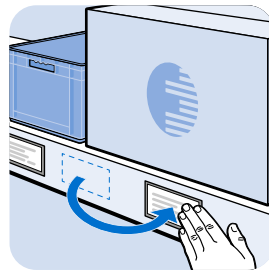
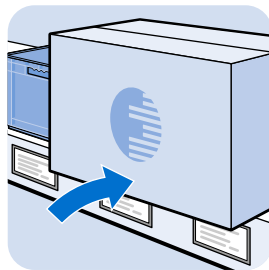
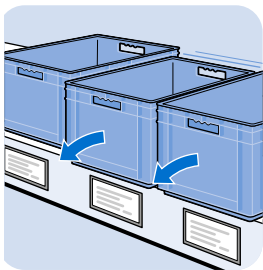

Fig. Abb.	Top Open Self-adhesive Label Envelope 37 - 1.5" Oben offene selbstklebende Etikettenhülle 37	Color Farbe	Weight [g] Gewicht [g]	Part # Teil-Nr.
①		Yellow ≈ RAL 1018 <i>gelb</i>	2.0	02021E37105TA15
②		Red ≈ RAL 3020 <i>rot</i>	2.0	02021E37105TA31
③		Blue ≈ RAL 5017 <i>blau</i>	2.0	02021E37105TA55
④		Green ≈ RAL 6016 <i>grün</i>	2.0	02021E37105TA63
⑤		Black <i>schwarz</i>	2.0	02021E37105TA91
⑥		White ≈ RAL 9003 <i>weiß</i>	2.0	02021E37105TA93



TOP OPEN SELF-ADHESIVE LABEL ENVELOPE 50 - 2"

OBEN OFFENE SELBSTKLEBENDE ETIKETTENHÜLLE 50

<p>Model Self-adhesive (multi-use)</p> <p>Description To hold labels; For flexible adhesion on shelves even on uneven surfaces, removable without leaving any residue, reusable on supporting surfaces thanks to multi-use properties; Top open, tear-resistant and stretchable transparent foil with restoring capacity, scanner-compatible</p> <p>Material Label envelope: Plastic, PVC Adhesive strip: PE foam, reusable</p> <p>Color Yellow, red, blue, green, black, white</p> <p>Pack Quantity 50 pieces</p>	<p>Ausführung selbstklebend (multi-use)</p> <p>Beschreibung zur Aufnahme von Etiketten; zum flexiblen Ankleben auf Regalen auch auf unebenen Oberflächen, rückstandsfrei entfernbar, mehrfach wiederverwendbar auf tragenden Untergründen dank multi-use Eigenschaft; oben offen, reißfeste und dehnbare Sichtfolie mit Rückstellvermögen, scannertauglich</p> <p>Material Etikettenhülle: Kunststoff, PVC Klebestreifen: PE-Schaumstoff, wiederverwendbar</p> <p>Farbe gelb, rot, blau, grün, schwarz, weiß</p> <p>Liefereinheit 50 Stück</p>
---	---

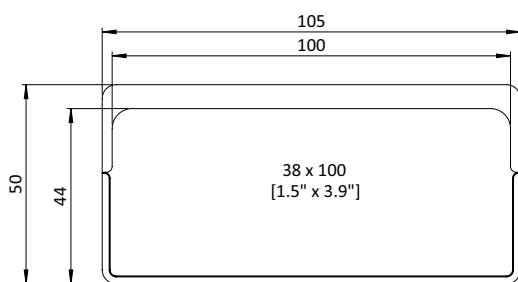
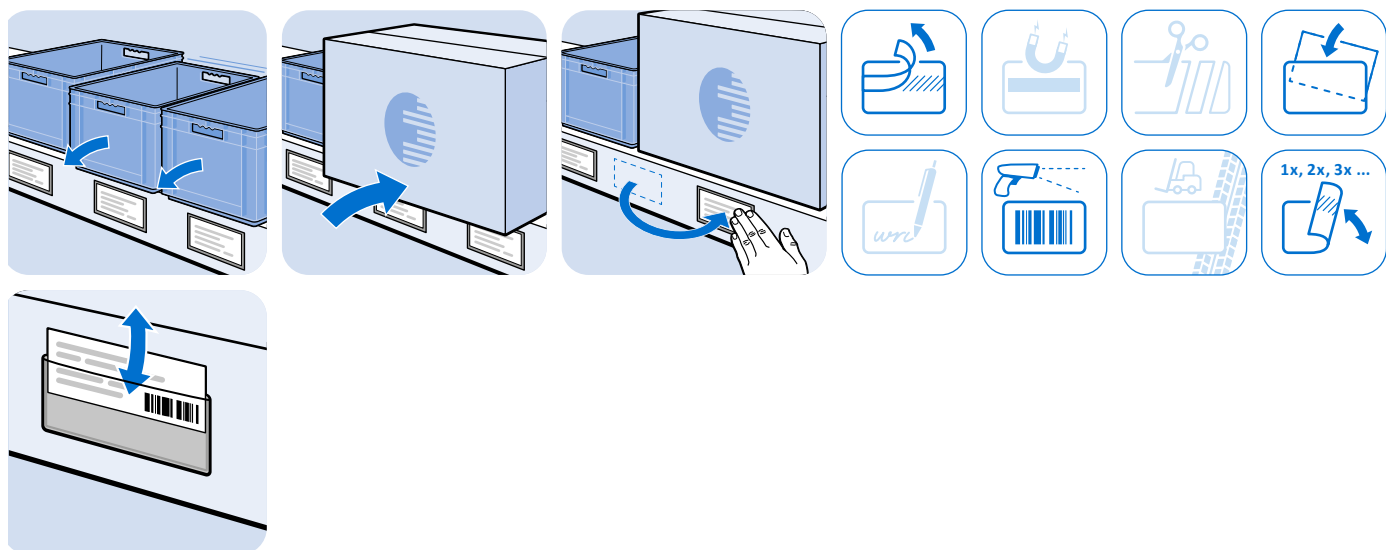

Fig. Abb.	Top Open Self-adhesive Label Envelope 50 - 2" Oben offene selbstklebende Etikettenhülle 50	Color Farbe	Weight [g] Gewicht [g]	Part # Teil-Nr.
①		Yellow ≈ RAL 1018 <i>gelb</i>	2.6	02021E50105TA15
②		Red ≈ RAL 3020 <i>rot</i>	2.6	02021E50105TA31
③		Blue ≈ RAL 5017 <i>blau</i>	2.6	02021E50105TA55
④		Green ≈ RAL 6016 <i>grün</i>	2.6	02021E50105TA63
⑤		Black <i>schwarz</i>	2.6	02021E50105TA91
⑥		White ≈ RAL 9003 <i>weiß</i>	2.6	02021E50105TA93



TOP OPEN MAGNETIC LABEL ENVELOPE 37 - 1.5"

OBEN OFFENE MAGNETISCHE ETIKETTENHÜLLE 37

Model	Magnetic	Ausführung	magnetisch
Description	To hold labels; For magnetic mounting on metallic surfaces, e.g. shelves; Top open, tear-resistant and stretchable transparent foil with restoring capacity, scanner-compatible	Beschreibung	zur Aufnahme von Etiketten; zur magnetischen Befestigung auf metallischen Oberflächen, z.B. Regalen; oben offen, reißfeste und dehnbare Sichtfolie mit Rückstellvermögen, scannertauglich
Material	Label envelope: Plastic, PVC Magnetic strip	Material	Etikettenhülle: Kunststoff, PVC Magnetstreifen
Color	Yellow, red, blue, green, black, white	Farbe	gelb, rot, blau, grün, schwarz, weiß
Pack Quantity	50 pieces	Liefereinheit	50 Stück

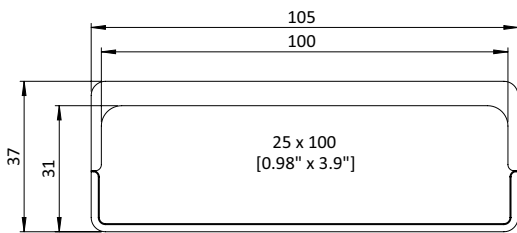
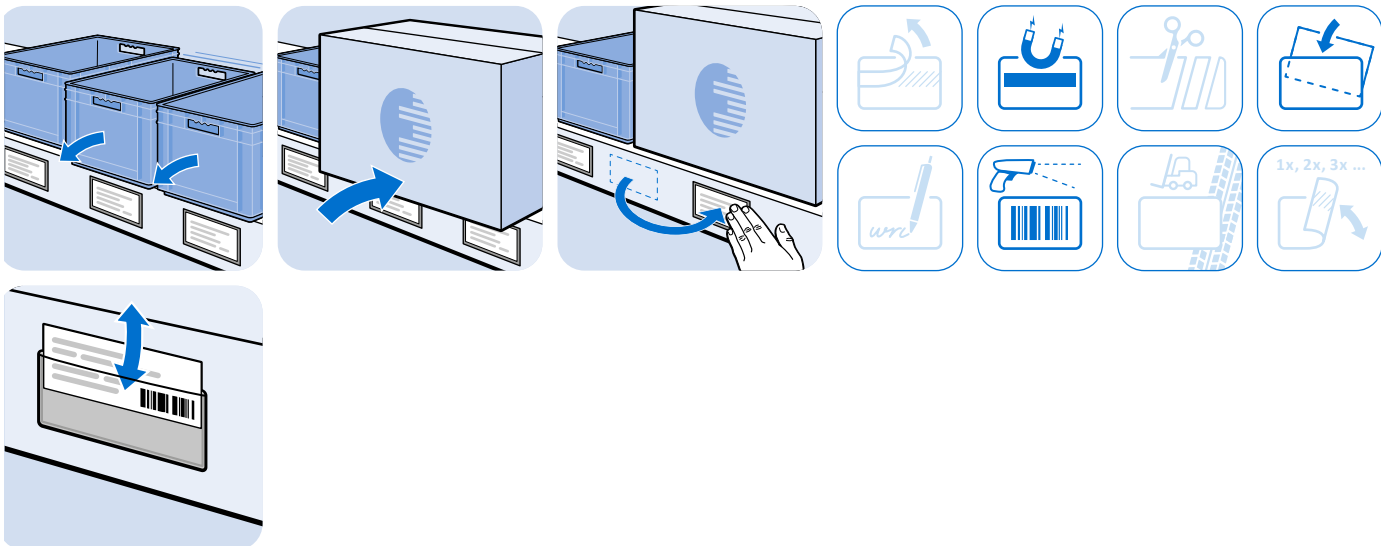

Fig. Abb.	Top Open Magnetic Label Envelope 37 - 1.5" Oben offene magnetische Etikettenhülle 37	Color Farbe	Weight [g] Gewicht [g]	Part # Teil-Nr.
①		Yellow ≈ RAL 1018 <i>gelb</i>	13.6	02021E37105TM15
②		Red ≈ RAL 3020 <i>rot</i>	13.6	02021E37105TM31
③		Blue ≈ RAL 5017 <i>blau</i>	13.6	02021E37105TM55
④		Green ≈ RAL 6016 <i>grün</i>	13.6	02021E37105TM63
⑤		Black <i>schwarz</i>	13.6	02021E37105TM91
⑥		White ≈ RAL 9003 <i>weiß</i>	13.6	02021E37105TM93



TOP OPEN MAGNETIC LABEL ENVELOPE 50 - 2"

OBEN OFFENE MAGNETISCHE ETIKETTENHÜLLE 50

Model	Magnetic	Ausführung	magnetisch
Description	To hold labels; For magnetic mounting on metallic surfaces, e.g. shelves; Top open, tear-resistant and stretchable transparent foil with restoring capacity, scanner-compatible	Beschreibung	zur Aufnahme von Etiketten; zur magnetischen Befestigung auf metallischen Oberflächen, z.B. Regalen; oben offen, reißfeste und dehnbare Sichtfolie mit Rückstellvermögen, scannertauglich
Material	Label envelope: Plastic, PVC Magnetic strip	Material	Etikettenhülle: Kunststoff, PVC Magnetstreifen
Color	Yellow, red, blue, green, black, white	Farbe	gelb, rot, blau, grün, schwarz, weiß
Pack Quantity	50 pieces	Lieferinheit	50 Stück

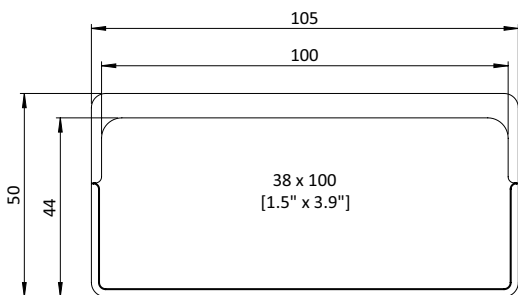
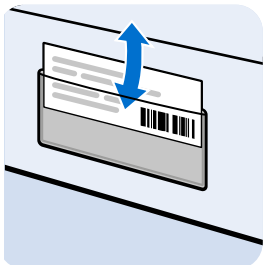
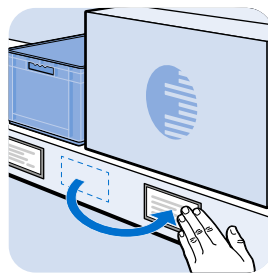
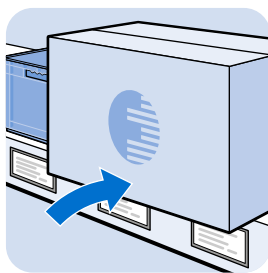
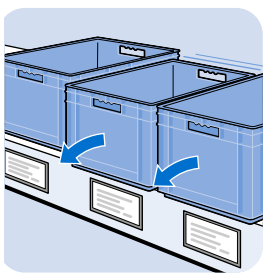

Fig. Abb.	Top Open Magnetic Label Envelope 50 - 2" Oben offene magnetische Etikettenhülle 50	Color Farbe	Weight [g] Gewicht [g]	Part # Teil-Nr.
①		Yellow ≈ RAL 1018 <i>gelb</i>	14.2	02021E50105TM15
②		Red ≈ RAL 3020 <i>rot</i>	14.2	02021E50105TM31
③		Blue ≈ RAL 5017 <i>blau</i>	14.2	02021E50105TM55
④		Green ≈ RAL 6016 <i>grün</i>	14.2	02021E50105TM63
⑤		Black <i>schwarz</i>	14.2	02021E50105TM91
⑥		White ≈ RAL 9003 <i>weiß</i>	14.2	02021E50105TM93



SIDE OPEN SELF-ADHESIVE LABEL ENVELOPE 60 - 2.4"

SEITLICH OFFENE SELBSTKLEBENDE ETIKETTENHÜLLE 60

Model	Self-adhesive (multi-use)	Ausführung	<i>selbstklebend (multi-use)</i>
Description	To hold labels; For flexible adhesion on shelves even on uneven surfaces, removable without leaving any residue, reusable on supporting surfaces thanks to multi-use properties; Side open only for special protection against wet and dust, tear-resistant and stretchable transparent foil with restoring capacity, scanner-compatible	Beschreibung	<i>zur Aufnahme von Etiketten; zum flexiblen Ankleben auf Regalen auch auf unebenen Oberflächen, rückstandsfrei entfernbar, mehrfach wiederverwendbar auf tragenden Untergründen dank multi-use Eigenschaft; nur seitlich offen für den besonderen Schutz gegen Nässe und Staub, reißfeste und dehnbare Sichtfolie mit Rückstellvermögen, scannertauglich</i>
Material	Label envelope: Plastic, PVC Adhesive strip: PE foam, reusable	Material	<i>Etikettenhülle: Kunststoff, PVC Klebestreifen: PE-Schaumstoff, wiederverwendbar</i>
Color	Yellow, red, blue, green, black, white	Farbe	<i>gelb, rot, blau, grün, schwarz, weiß</i>
Pack Quantity	50 pieces	Liefereinheit	<i>50 Stück</i>

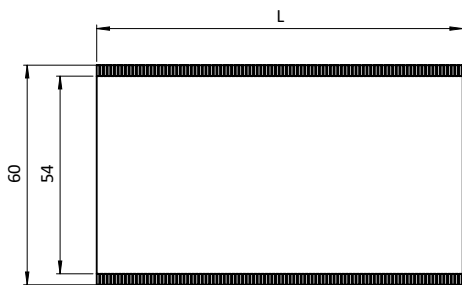
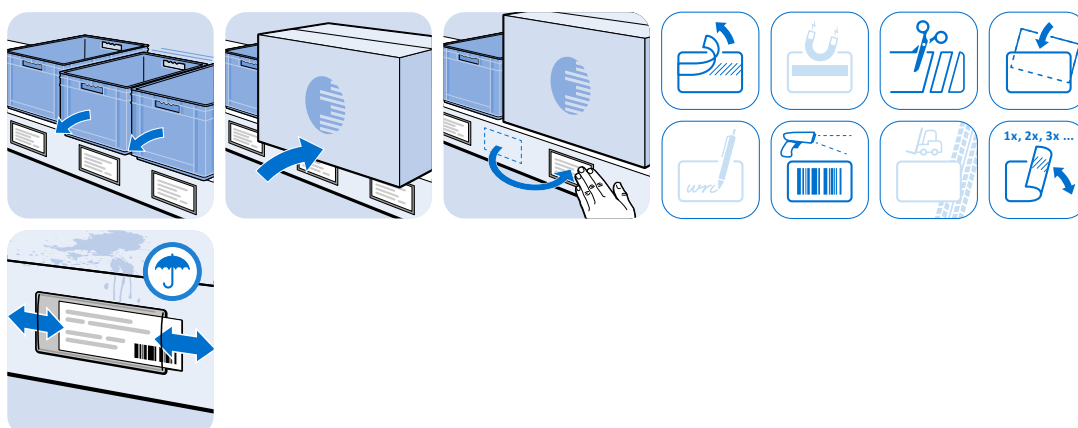

Fig. Abb.	Side Open Self-adhesive Label Envelope 60 - 2.4" <i>Seitlich offene selbstklebende Etikettenhülle 60</i>	Color <i>Farbe</i>	L [mm]	Weight [g] <i>Gewicht [g]</i>	Part # <i>Teil-Nr.</i>
①		Yellow ≈ RAL 1018 <i>gelb</i>	100.0	2.8	02021E60100SA15
②		Red ≈ RAL 3020 <i>rot</i>	100.0	2.8	02021E60100SA31
③		Blue ≈ RAL 5017 <i>blau</i>	100.0	2.8	02021E60100SA55
④		Green ≈ RAL 6016 <i>grün</i>	100.0	2.8	02021E60100SA63
⑤		White ≈ RAL 9003 <i>weiß</i>	100.0	2.8	02021E60100SA93
①		Yellow ≈ RAL 1018 <i>gelb</i>	200.0	5.7	02021E60200SA15
②		Red ≈ RAL 3020 <i>rot</i>	200.0	5.7	02021E60200SA31
③		Blue ≈ RAL 5017 <i>blau</i>	200.0	5.7	02021E60200SA55
④		Green ≈ RAL 6016 <i>grün</i>	200.0	5.7	02021E60200SA63
⑤		White ≈ RAL 9003 <i>weiß</i>	200.0	5.7	02021E60200SA93
①		Yellow ≈ RAL 1018 <i>gelb</i>	300.0	8.5	02021E60300SA15
②		Red ≈ RAL 3020 <i>rot</i>	300.0	8.5	02021E60300SA31
③		Blue ≈ RAL 5017 <i>blau</i>	300.0	8.5	02021E60300SA55
④		Green ≈ RAL 6016 <i>grün</i>	300.0	8.5	02021E60300SA63
⑤		White ≈ RAL 9003 <i>weiß</i>	300.0	8.5	02021E60300SA93



SIDE OPEN MAGNETIC LABEL ENVELOPE 60 - 2.4"

SEITLICH OFFENE MAGNETISCHE ETIKETTENHÜLLE 60

Model	Magnetic	Ausführung	magnetisch
Description	To hold labels; For magnetic mounting on metallic surfaces, e.g. shelves; Side open only for special protection against wet and dust, tear-resistant and stretchable transparent foil with restoring capacity, scanner-compatible	Beschreibung	zur Aufnahme von Etiketten; zur magnetischen Befestigung auf metallischen Oberflächen, z.B. Regalen; nur seitlich offen für den besonderen Schutz gegen Nässe und Staub, reißfeste und dehnbare Sichtfolie mit Rückstellvermögen, scannertauglich
Material	Label envelope: Plastic, PVC Magnetic strip	Material	Etikettenhülle: Kunststoff, PVC Magnetstreifen
Color	Yellow, red, blue, green, black, white	Farbe	gelb, rot, blau, grün, schwarz, weiß
Pack Quantity	50 pieces	Lieferereinheit	50 Stück

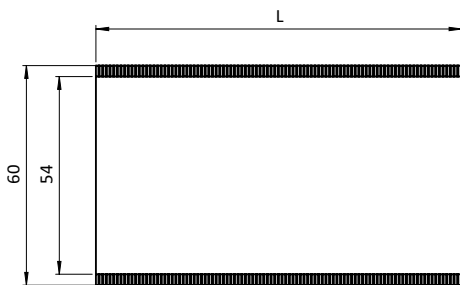
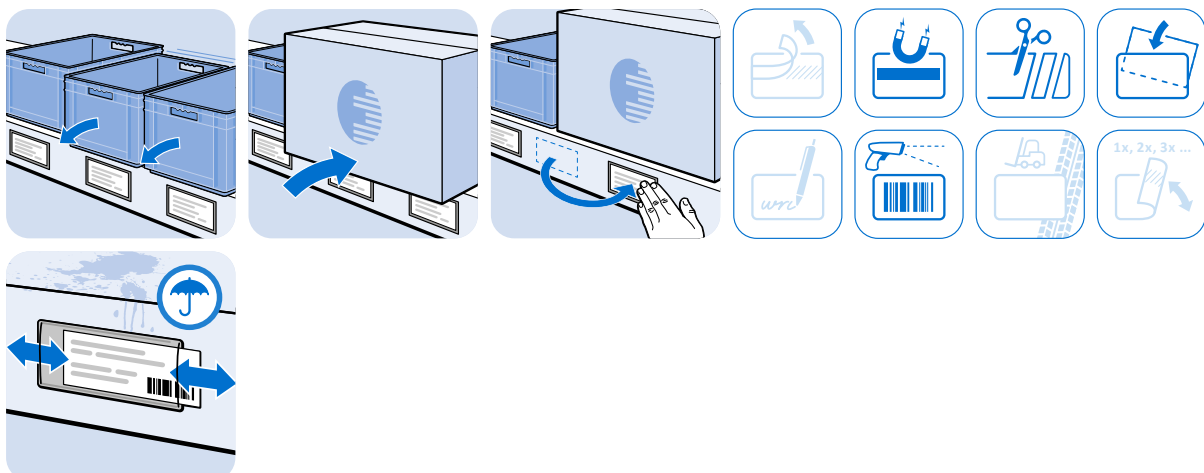

Fig. Abb.	Side Open Magnetic Label Envelope 60 - 2.4" Seitlich offene magnetische Etikettenhülle 60	Color Farbe	L [mm]	Weight [g] Gewicht [g]	Part # Teil-Nr.
①		Yellow ≈ RAL 1018 <i>gelb</i>	100.0	13.7	02021E60100SM15
②		Red ≈ RAL 3020 <i>rot</i>	100.0	13.7	02021E60100SM31
③		Blue ≈ RAL 5017 <i>blau</i>	100.0	13.7	02021E60100SM55
④		Green ≈ RAL 6016 <i>grün</i>	100.0	13.7	02021E60100SM63
⑤		White ≈ RAL 9003 <i>weiß</i>	100.0	13.7	02021E60100SM93
①		Yellow ≈ RAL 1018 <i>gelb</i>	200.0	28.9	02021E60200SM15
②		Red ≈ RAL 3020 <i>rot</i>	200.0	28.9	02021E60200SM31
③		Blue ≈ RAL 5017 <i>blau</i>	200.0	28.9	02021E60200SM55
④		Green ≈ RAL 6016 <i>grün</i>	200.0	28.9	02021E60200SM63
⑤		White ≈ RAL 9003 <i>weiß</i>	200.0	28.9	02021E60200SM93
①		Yellow ≈ RAL 1018 <i>gelb</i>	300.0	43.3	02021E60300SM15
②		Red ≈ RAL 3020 <i>rot</i>	300.0	43.3	02021E60300SM31
③		Blue ≈ RAL 5017 <i>blau</i>	300.0	43.3	02021E60300SM55
④		Green ≈ RAL 6016 <i>grün</i>	300.0	43.3	02021E60300SM63
⑤		White ≈ RAL 9003 <i>weiß</i>	300.0	43.3	02021E60300SM93



FLOOR MARKINGS *BODENMARKIERUNGEN*



Container Labelings
Behälterkennzeichnungen 1

Shelf Labelings
Regalkennzeichnungen 2

**Floor Markings
Bodenmarkierungen 3**

Stickers
Aufkleber 4

Inserting Systems
Einstecksysteme 5





Visual Boards
Visual Boards 6

MATERIAL FLOW *MATERIALFLUSS*

Material Transport
Materialtransport 7

Material Supply
Materialbereitstellung 8

	Floor Marking Tape 50 <i>Bodenmarkierungsband 50</i>	73		Floor Window 1/3 DIN A4 Portrait - 8.3" x 3.9" <i>Bodenfenster 1/3 DIN A4 hoch</i>	87
	Floor Marking Tape 75 <i>Bodenmarkierungsband 75</i>	74		Floor Window DIN A4 - 8.3" x 11.7" <i>Bodenfenster DIN A4</i>	88
	Floor Marking T-shape 50 <i>Bodenmarkierung T-Form 50</i>	79		Floor Window 1/2 DIN A4 Landscape - 11.7" x 4.1" <i>Bodenfenster 1/2 DIN A4 quer</i>	89
	Floor Marking T-shape 75 <i>Bodenmarkierung T-Form 75</i>	80		No Forklift Traffic Floor Sign <i>Für Flurförderzeuge verboten Bodenschild</i>	93
	Floor Marking L-shape 50 <i>Bodenmarkierung L-Form 50</i>	81		No Stopping Floor Sign <i>Halteverbot Bodenschild</i>	94
	Floor Marking L-shape 75 <i>Bodenmarkierung L-Form 75</i>	82		No Entry Floor Sign <i>Verbot der Einfahrt Bodenschild</i>	95
	Floor Marking I-shape 50 <i>Bodenmarkierung I-Form 50</i>	83		No Smoking Floor Sign <i>Rauchen verboten Bodenschild</i>	96
	Floor Marking I-shape 75 <i>Bodenmarkierung I-Form 75</i>	84		No Pedestrian Floor Sign <i>Für Fußgänger verboten Bodenschild</i>	97
	Floor Marking Foot Shape 90 <i>Bodenmarkierung Fuss-Form 90</i>	85		Wear Hearing Protection Floor Sign <i>Gehörschutz tragen Bodenschild</i>	98
	Floor Window DIN A5 - 5.8" x 8.3" <i>Bodenfenster DIN A5</i>	86		Safety Vest Required Floor Sign <i>Warnweste tragen Bodenschild</i>	99

	Traffic Arrow Floor Sign <i>Richtungshinweis Bodenschild</i>	100
	Hard Hat Area Floor Sign <i>Kopfschutz benutzen Bodenschild</i>	101
	Safety Glasses Required Floor Sign <i>Augenschutz benutzen Bodenschild</i>	102
	Safety Shoes Required Floor Sign <i>Fußschutz benutzen Bodenschild</i>	103
	Pedestrian Route Floor Sign <i>Fußgängerweg benutzen Bodenschild</i>	104
	Drive Slowly Floor Sign <i>Schritt fahren Bodenschild</i>	105
	Stop Floor Sign <i>Stop Bodenschild</i>	106
	Caution Forklift Zone Floor Sign <i>Warnung vor Flurförderzeugen Bodenschild</i>	107

- 1
- 2
- 3
- 4
- 5
- 6
- 7
- 8

simply
practical

FATH®
COMPONENTS



FLOOR MARKING TAPES BODENMARKIERUNGSBÄNDER

SELF-ADHESIVE,
FORKLIFT-RESILIENT, FLEXIBLE
SELBSTKLEBEND, STAPLERFEST,
FLEXIBEL

**FLEXIBLE AND LEAN: MARK AREAS EASILY AND RELIABLY WITH SELF-ADHESIVE FATH FLOOR MARKING TAPES
FLEXIBEL UND LEAN: FLÄCHEN EINFACH UND SICHER MARKIEREN MIT DEN SELBSTKLEBENDEN FATH
BODENMARKIERUNGSBÄNDERN**

Floor marking tapes for quick and heavy-duty labeling

- Outstanding adhesive strength
- Forklift-resilient
- Suitable for almost all industrial floors and removable without leaving residue
- Very sturdy and stable: Easily adhered to industrial floors
- Available in all relevant colors

- **FORKLIFT-RESILIENT**
- **REMOVABLE WITHOUT LEAVING RESIDUE**

Bodenmarkierungsbänder für die schnelle und strapazierfähige Kennzeichnung

- *Hohe Haftkraft*
- *Staplerfest*
- *Für nahezu alle Industrieböden geeignet und rückstandsfrei ablösbar*
- *Sehr formstabil: Verklebung ohne vorheriges Anzeichnen*
- *In allen relevanten Farben erhältlich*

- **STAPLERFEST**
- **RÜCKSTANDSFREI ABLÖSBAR**

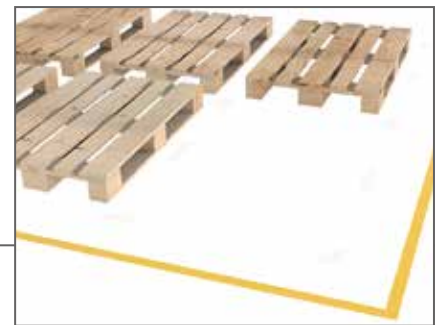

MAKE SURE YOU MARK CORRECTLY: A QUICK COLOR ADVISOR SO MARKIEREN SIE RICHTIG: EIN KURZER FARBRATGEBER

FATH's floor marking tapes are available in rolls 50 mm wide in all key marking colors with a single- or double-color design. This enables companies to set up a secure color guidance system for walkways, separate areas, parking spaces, parking lots and entire areas in production plants and warehouses. When used correctly, the selected colors provide recognition of safety importance, for example:

- Black/yellow:** Marking of hazardous areas, obstacles, and radioactive material
- White/red:** Hazardous areas in construction, easily flammable objects, and fire extinguishers
- Yellow:** Marked-off work areas, vehicle routes and walkways
- Red:** Defective goods and defective raw materials
- Blue:** Semi-finished products and material for further processing
- Green:** Finished products

Die FATH Bodenmarkierungsbänder sind als Rollenware mit 50 mm Breite in allen wichtigen Markierungsfarben erhältlich – in einfarbiger und zweifarbiger Ausführung. Damit lässt sich ein sicheres Farbleitsystem für Wege, Flächen, Stellplätze, Parkplätze und ganze Bereiche in Produktionsstätten und Lagern einrichten. Richtig eingesetzt, sorgen die gewählten Farben für eine weitgehend intuitive Erkennung der Bedeutung:

- Schwarz/Gelb:** Kennzeichnung von Gefahrenstellen, Hindernissen und radioaktivem Material
- Weiß/Rot:** Gefahrenstellen im Baubereich, leicht entflammbare Objekte, Feuerlöscher
- Gelb:** Abgegrenzte Arbeitszonen, Fahrwege und Fußwege
- Rot:** Defekte Ware, Sperrlager
- Blau:** Halbzeug und Material zur weiteren Verarbeitung
- Grün:** Fertige Produkte

Self-adhesive floor marking tapes: forklift-resilient and affixes instantly

The self-adhesive, sturdy **FATH** floor marking tapes are custom-made and can easily be adhered to industrial floors. Vehicles can drive over them immediately and they are easy to clean. They are suitable for almost all industrial floors and substrates such as stone, concrete or metal. Unlike with paint or lacquer markings, there are no long drying times and no unpleasant odors when you apply **FATH's** floor marking tapes. Thanks to the hard-wearing plastic surface suitable for industrial use, the floor marking tapes withstand heavy use by forklift trucks.

Full flexibility with new production requirements

The self-adhesive floor marking tapes can be detached from the floor without leaving any residue and then reaffixed as needed if production changes, reorganization or expansions to facilities are planned. The floor remains intact after removing the adhesive tapes, because no chemicals or acidic substances are required. Leased buildings, warehouses and spaces can also be temporarily labeled without causing any damage. That is lean!

Safety increases by the separation of production areas and walkways

One of the most important functions of floor marking is separating vehicle routes and walkways. Clearly marked walkways ensure that employees and visitors stay safe if industrial trucks or forklifts are moving around the production area or warehouse. **FATH's** floor marking tapes effectively show the separation of vehicle routes from walkways. ASR A1.3 specifies that vehicle routes should be delimited by marking strips at least 5 cm wide. Steps can also be clearly marked with adhesive tapes in signal colors to minimize the risk of falling.

Selbstklebende Bodenmarkierungsbänder: staplerfest und blitzschnell angebracht

Die selbstklebenden, formstabilen **FATH** Bodenmarkierungsbänder werden individuell zugeschnitten und können ohne vorheriges Anzeichnen aufgeklebt werden, sind sofort befahrbar und leicht zu reinigen. Sie eignen sich für nahezu alle Industrieböden und Untergründe wie Stein, Beton oder Metall. Im Gegensatz zu Markierungen mittels Lack oder Farbe, entfallen bei der Klebelösung lange Trocknungszeiten und es entsteht keine Geruchsbelästigung. Dank industrietauglicher, strapazierfähiger Kunststoffoberfläche halten die Bodenmarkierungsbänder der starken Belastung durch Gabelstapler stand.

Volle Flexibilität bei neuen Produktionsanforderungen

Die selbstklebenden Bodenmarkierungsbänder können rückstandsfrei vom Boden abgelöst und bedarfsgerecht neu angebracht werden, wenn Produktionsumstellungen, Umstrukturierungen oder Betriebserweiterungen anstehen. Der Boden bleibt nach dem Ablösen der Klebebänder intakt, da keine Chemie oder säurehaltigen Substanzen nötig sind. Auch geleaste Gebäude, Lagerhallen und Flächen können temporär und ohne Folgeschäden gekennzeichnet werden. Auch das ist lean!

Sicherheit durch Trennung von Produktionsbereichen und Gehwegen

Eine der wichtigsten Funktionen der Bodenmarkierung ist die Trennung von Fahr- und Gehwegen. Sind im Produktionsbereich bzw. Lager Flurförderfahrzeuge oder Gabelstapler unterwegs, gewährleisten klar markierte Gehwege die Sicherheit von Personal und Besuchern. Mit den einfachen, effektiven **FATH** Bodenmarkierungsbändern kommen Sie der Verpflichtung nach, die Fahrwege visuell von den Gehwegen zu trennen. Laut ASR A1.3 sollte die Fahrwegbegrenzung durch mindestens 5 cm breite Markierungstreifen erfolgen. Auch Treppenstufen lassen sich zur Minimierung der Sturzgefahr mit Klebebändern in Signalfarben deutlich kennzeichnen.

**VERSIONS
 AUSFÜHRUNGEN**

The self-adhesive floor marking tapes are available in the following versions:
 Die selbstklebenden Bodenmarkierungsbänder sind in folgenden Ausführungen erhältlich:

Roll	Length: 50 m (165 feet) Width: 50 mm	Rolle	Länge: 50 m Breite: 50 mm
Colors	① Yellow ② Red ③ Blue ④ Green ⑤ Black/Yellow ⑥ Red/White	Farben	① Gelb ② Rot ③ Blau ④ Grün ⑤ Schwarz/Gelb ⑥ Rot/Weiß

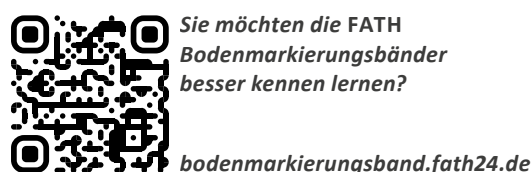
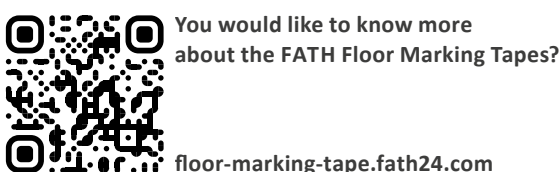

FLOOR MARKING TAPE 50

BODENMARKIERUNGSBAND 50

Model	Diverse colors	Ausführung	verschiedene Farben
Description	For easy and reliable marking of path boundaries, stairs, parking / storage / working areas etc., self-adhesive; Forklift-resistant and stable floor marking with outstanding adhesive strength, suitable for almost all industrial floors, removable without leaving residue	Beschreibung	zum schnellen und sicheren Kennzeichnen von Wegbegrenzungen, Treppenstufen, Abstellflächen, Arbeitsbereichen etc., selbstklebend; staplerfeste und formstabile Bodenmarkierung mit hoher Haltekraft, für nahezu alle Industrieböden geeignet, rückstandsfrei ablösbar
Material	Plastic PVC	Material	Kunststoff PVC
Color	Yellow, red, blue, green, black / yellow, red / white	Farbe	gelb, rot, blau, grün, schwarz / gelb, rot / weiß
Fastening	Self-adhesive surface on the backside	Befestigung	mit rückseitiger Selbstklebefläche
Pack Quantity	50 meters (spool)	Lieferinheit	50 Meter (Rolle)

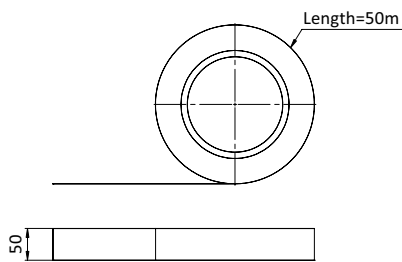
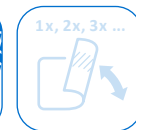
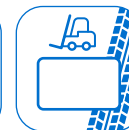
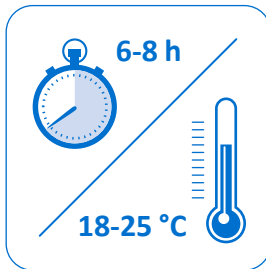
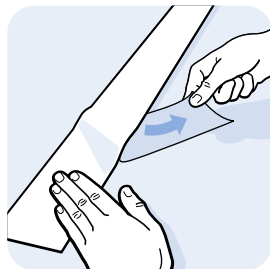

Fig. Abb.	Floor Marking Tape 50 Bodenmarkierungsband 50	Color Farbe	Weight [g] Gewicht [g]	Part # Teil-Nr.
①		Yellow ≈ RAL 1018 <i>gelb</i>	1664.0	0203T05015
②		Red ≈ RAL 3020 <i>rot</i>	1664.0	0203T05031
③		Blue ≈ RAL 5017 <i>blau</i>	1664.0	0203T05055
④		Green ≈ RAL 6016 <i>grün</i>	1664.0	0203T05063
⑤		Black / yellow <i>schwarz / gelb</i>	1664.0	0203T0501591
⑥		Red / white <i>rot / weiß</i>	1664.0	0203T0503193



FLOOR MARKING TAPE 75

BODENMARKIERUNGSBAND 75

Model	Diverse colors	Ausführung	verschiedene Farben
Description	For easy and reliable marking of path boundaries, stairs, parking / storage / working areas etc., self-adhesive; Forklift-resistant and stable floor marking with outstanding adhesive strength, suitable for almost all industrial floors, removable without leaving residue	Beschreibung	zum schnellen und sicheren Kennzeichnen von Wegbegrenzungen, Treppenstufen, Abstellflächen, Arbeitsbereichen etc., selbstklebend; staplerfeste und formstabile Bodenmarkierung mit hoher Haltekraft, für nahezu alle Industrieböden geeignet, rückstandsfrei ablösbar
Material	Plastic PVC	Material	Kunststoff PVC
Color	Yellow, red, blue, green	Farbe	gelb, rot, blau, grün
Fastening	Self-adhesive surface on the backside	Befestigung	mit rückseitiger Selbstklebefläche
Pack Quantity	50 meters (spool)	Liefereinheit	50 Meter (Rolle)

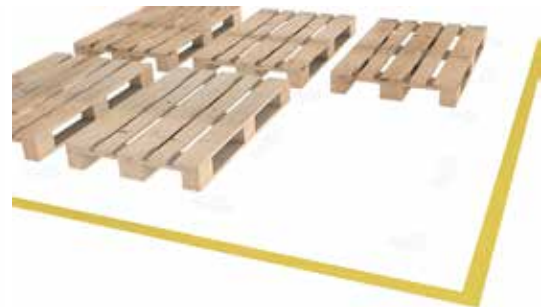
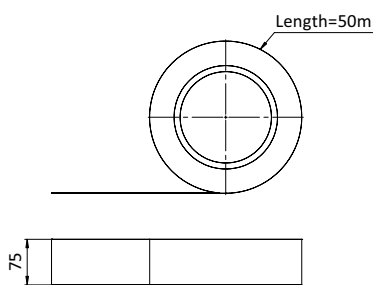
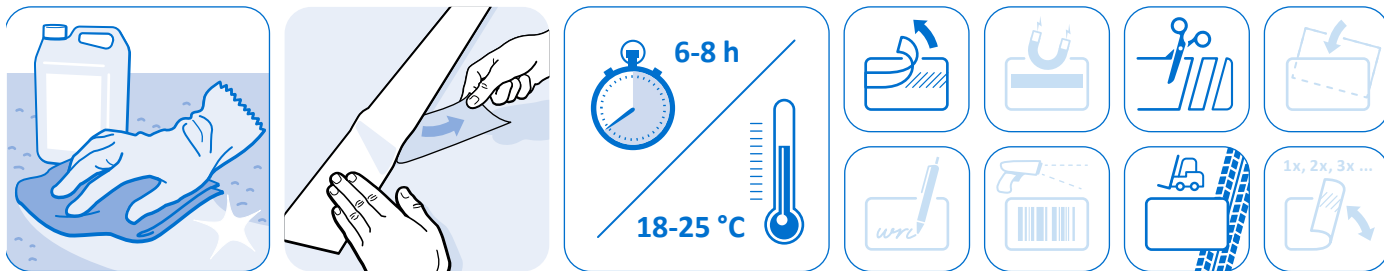

Fig. Abb.	Floor Marking Tape 75 Bodenmarkierungsband 75	Color Farbe	Weight [g] Gewicht [g]	Part # Teil-Nr.
①		Yellow ≈ RAL 1018 <i>gelb</i>	2500.0	0203T07515
②		Red ≈ RAL 3020 <i>rot</i>	2500.0	0203T07531
③		Blue ≈ RAL 5017 <i>blau</i>	2500.0	0203T07555
④		Green ≈ RAL 6016 <i>grün</i>	2500.0	0203T07563



simply
practical

FATH®
COMPONENTS



FLOOR MARKING SHAPES AND FLOOR WINDOWS BODENMARKIERUNGSFORMEN UND BODENFENSTER

SELF-ADHESIVE, FORKLIFT-
RESISTANT, FLEXIBLE
SELBSTKLEBEND, STAPLERFEST,
FLEXIBEL

FLEXIBLE AND LEAN: FATH SELF-ADHESIVE FLOOR MARKING SHAPES AND FLOOR WINDOWS FLEXIBEL UND LEAN: FLÄCHEN MARKIEREN MIT DEN SELBSTKLEBENDEN FATH BODENMARKIERUNGS- FORMEN UND BODENFENSTERN

FATH Floor Marking Shapes: more organized, more efficient
The practical **FATH** floor marking shapes come pre-punched. Easy to attach, they provide secure and effective storage space labeling in production and warehouse areas. After the labels are attached, the floor shapes can be walked and driven on immediately. Areas for pallets, shelving, containers, carts etc. can be marked accurately – creating a strong visual effect. Generally the L shape is used for side area boundaries and the T shape is used for demarcation mark between two storage positions. Floor labeling allows you to create a clear structure of surfaces and areas, reduce the amount of floor space needed and assists staff in working efficiently.

- RESISTANT
- REMOVABLE WITHOUT LEAVING RESIDUE

FATH Bodenmarkierungsformen: mehr Ordnung, mehr Effizienz
Die praktischen **FATH** Bodenmarkierungsformen sind bereits vorgestanzt. Durch einfaches Aufkleben erreichen Sie eine sichere und effektive Stellplatzkennzeichnung in Produktion und Lager. Nach dem Anbringen sind die Bodenformen sofort begehbar und befahrbar. Flächen für Paletten, Regale, Behälter, Rollwagen etc. lassen sich exakt markieren – mit einem starken visuellen Effekt. In der Regel wird die L-Form für seitliche Flächenbegrenzungen und die T-Form zur Abgrenzung zwischen zwei Stellplätzen eingesetzt. Durch die Bodenmarkierung schaffen Sie eine klare Strukturierung der Flächen und Bereiche, senken den Platzbedarf und unterstützen die Mitarbeiter beim effizienten Arbeiten.

- WIDERSTANDSFÄHIG
- RÜCKSTANDSFREI ABLÖSBAR

FATH FLOOR WINDOWS: FORKLIFT-RESISTANT, SCRATCH-RESISTANT AND SCANNER READABLE FATH BODENFENSTER: STAPLERFEST, KRATZFEST UND SCANNERLESBAR

The special feature of the **FATH** floor windows: The yellow frame is printed on the inside of the floor window, allowing the signal color to be fully enclosed, providing permanent protection against wear and scratching. The color also remains visible after prolonged use – even heavy use in areas driven over by forklift trucks cannot wear the floor windows.

Documents of different sizes up to DIN A4 (8.3" x 11.7") are inserted behind the transparent plastic window and are scanner readable through the viewing window. The 40 mm frame width ensures immediate recognition, even from a distance. Allowing the worker to easily view what kind of material is available and that is in the right position.

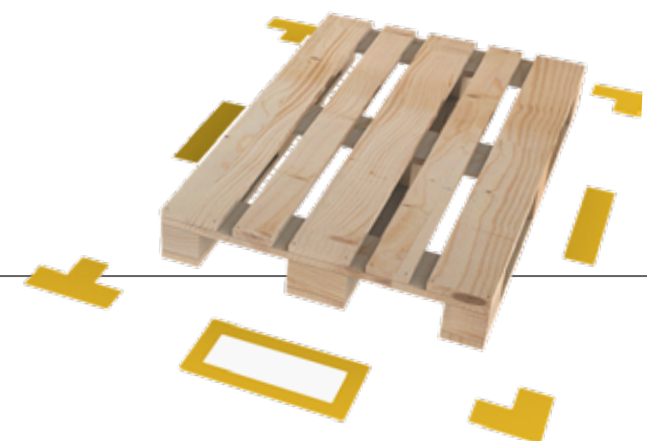

Das Besondere an den **FATH** Bodenfenstern: Der Farbdruck für den gelben Rahmen ist auf der Innenseite angebracht. Dadurch wird die Signalfarbe vollständig eingeschlossen und ist somit dauerhaft vor Abnutzung und Verkratzen geschützt. Die Farbe bleibt auch bei langem Einsatz sichtbar – selbst eine starke Beanspruchung der Oberfläche durch Überfahren kann den Bodenfenstern nichts anhaben.

Hinter das Fenster aus durchsichtigem Kunststoff werden die Belege in den unterschiedlichen Maßen bis DIN A4 eingesteckt und sind durch das Sichtfenster scannerlesbar. Die Rahmenbreite von 40 mm gewährleistet ein sofortiges Erkennen, auch aus der Entfernung. Es ist sofort erkennbar, welches Material verfügbar ist und ob es an der richtigen Position steht.

FLOOR MARKING SHAPES AND FLOOR WINDOWS FOR QUICK AND PERMANENT LABELING *BODENMARKIERUNGSFORMEN UND BODENFENSTER FÜR DIE SCHNELLE UND STRAPAZIERFÄHIGE KENNZEICHNUNG*

- Outstanding adhesive strength
- Forklift-resistant
- Suitable for almost all industrial floors and removable without leaving residue
- Pre-punched shapes in L/T/I/foot shape
- Windows for DIN A4 (8.3" x 11.7"), DIN A5 (5.8" x 8.3"), 1/3 DIN A4 (8.3" x 3.9") and 1/2 DIN A4 (11.7" x 4.1") documents
- Scanner readable
- Very sturdy and easily adhered to the industrial floor
- Available in a range of colors

- *Hohe Haftkraft*
- *Staplerfest*
- *Für nahezu alle Industrieböden geeignet und rückstandsfrei ablösbar*
- *Vorgestanzte Formen in L-/T-/I-/Fuß-Form*
- *Fenster für DIN A4, DIN A5, 1/3 DIN A4 und 1/2 DIN A4 Belege*
- *Scannerlesbar*
- *Sehr formstabil: Verklebung ohne vorheriges Anzeichnen*
- *In mehreren Farben erhältlich*

FULL FLEXIBLE WITH NEW PRODUCTION REQUIREMENTS *VOLLE FLEXIBILITÄT BEI NEUEN PRODUKTIONSANFORDERUNGEN*

The self-adhesive floor marking shapes and floor windows can be removed from the floor without leaving any residue and renew then reattached, for production changeovers, reorganizations or plant expansions. The floor remains intact after removing the adhesive tapes, because no chemicals or acidic substances are required. Leased buildings, warehouses and spaces can also be temporarily labeled without consequential damages. That is lean!

Die selbstklebenden Bodenmarkierungsformen und Bodenfenster können rückstandsfrei vom Boden abgelöst und bedarfsgerecht neu angebracht werden, wenn Produktionsumstellungen, Umstrukturierungen oder Betriebserweiterungen anstehen. Der Boden bleibt nach dem Ablösen der Klebebänder intakt, da keine Chemie oder säurehaltige Substanzen nötig sind. Auch geleaste Gebäude, Lagerhallen und Flächen können temporär und ohne Folgeschäden gekennzeichnet werden. Das ist lean!

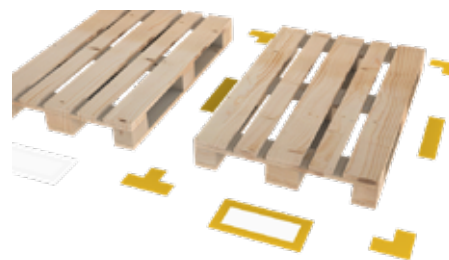

IMMEDIATE VISUALIZATION – WITHOUT THE DISADVANTAGES OF PAINT AND INK SOFORTIGE VISUALISIERUNG – OHNE DIE NACHTEILE VON LACK UND FARBE

The self-adhesive, durable **FATH** floor marking shapes and floor windows are easy to attach in the desired position, can be driven on immediately and are easy to clean. They are suitable for almost all industrial floors and substrates such as stone, concrete or metal.

In contrast to markings using paint or ink, this adhesive solution avoids long drying times and unpleasant odors. Thanks to the extremely durable surface suitable for industrial use, the floor shapes withstand heavy stress from forklift trucks, even when turning. Ideal for labeling pallet storage positions.

FATH tip: When the floor marking shapes are affixed with a spacing of approx. 30 mm to the product areas, they are well protected against wear.

Die selbstklebenden, formstabilen FATH Bodenmarkierungsformen und Bodenfenster werden einfach an der gewünschten Stelle aufgeklebt, sind sofort befahrbar und leicht zu reinigen. Sie eignen sich für nahezu alle Industrieböden und Untergründe wie Stein, Beton oder Metall.

Im Gegensatz zu Markierungen mittels Lack oder Farbe, entfallen bei der Klebelösung lange Trocknungszeiten und es entsteht keine Geruchsbelästigung. Dank industrietauglicher, strapazierfähiger Kunststoffoberfläche halten die Bodenformen der starken Belastung durch Gabelstapler stand, selbst beim Drehen. Perfekt für die Stellplatzkennzeichnung von Paletten.

FATH Tipp: Werden die Bodenmarkierungsformen im Abstand von ca. 30 mm zu den Bereitstellungsflächen angebracht, sind sie gut vor dem Verschleiß geschützt.

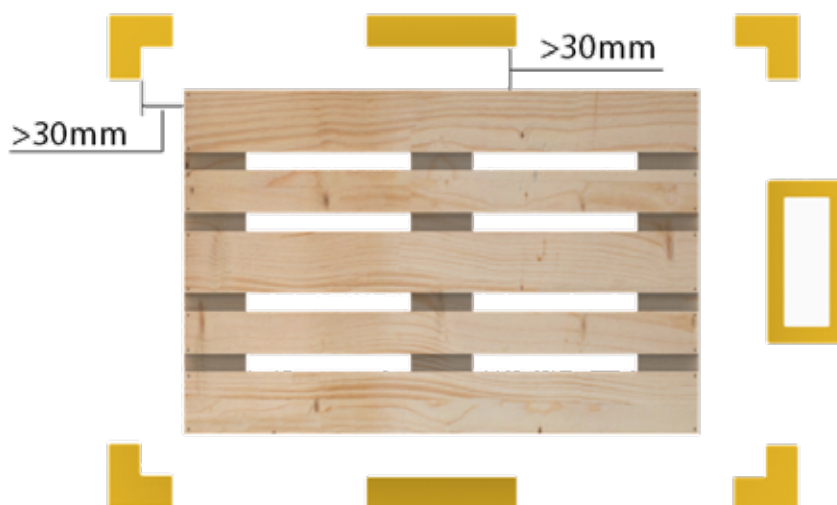

MAKE SURE YOU MARK CORRECTLY: A QUICK COLOR ADVISOR SO MARKIEREN SIE RICHTIG: EIN KURZER FARBRATGEBER

The **FATH** floor marking shapes enable an efficient color coding system to be set up for specific areas in production and warehousing, such as: storage positions, parking spaces, storage shelves etc. When used correctly, the selected colors allow the workers to intuitively recognize the importance, for example:

Yellow: Goods for processing
Red: Defective goods and defective raw material
Blue: Semi-finished product and material for further processing
Green: Finished products

Mit den FATH Bodenmarkierungsformen lässt sich ein effizientes Farbleitsystem für Flächen, Stellplätze, Parkplätze, Regalplätze etc. in Produktion und Lager einrichten. Richtig eingesetzt, sorgen die gewählten Farben für eine weitgehend intuitive Erkennung der Bedeutung, zum Beispiel:

Gelb: Ware zur Verarbeitung
Rot: Defekte Ware, Fehlerhaftes Rohmaterial, Sperrlager
Blau: Halbzeug und Material zur weiteren Verarbeitung
Grün: Fertige Produkte

VERSIONS
AUSFÜHRUNGEN

The self-adhesive floor marking shapes and floor windows are available in the following versions:

Die selbstklebenden Bodenmarkierungsformen und Bodenfenster sind in folgenden Ausführungen erhältlich:

	FATH Floor Marking Shapes FATH Bodenmarkierungsformen	FATH Floor Windows FATH Bodenfenster
Formats <i>Formate</i>	T shape L shape I shape Foot print <i>T-Form</i> <i>L-Form</i> <i>I-Form</i> <i>Fuß-Form</i>	DIN A4 (8.3" x 11.7") DIN A5 (5.8" x 8.3") 1/2 DIN A4 landscape (11.7" x 4.1") 1/3 DIN A4 portrait (8.3" x 3.9") <i>DIN A4</i> <i>DIN A5</i> <i>1/2 DIN A4 quer</i> <i>1/3 DIN A4 hoch</i>
Colors <i>Farben</i>	yellow red blue green <i>gelb</i> <i>rot</i> <i>blau</i> <i>grün</i>	yellow red blue green <i>gelb</i> <i>rot</i> <i>blau</i> <i>grün</i>

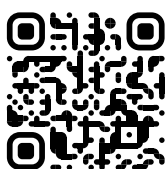

You would like to know more about the FATH Floor Marking Shapes and Floor Windows?

shape-window.fath24.com



Sie möchten die FATH Bodenmarkierungsformen und FATH Bodenfenster besser kennen lernen?

form-fenster.fath24.de

FLOOR MARKING T-SHAPE 50

BODENMARKIERUNG T-FORM 50

Model	Diverse colors	Ausführung	verschiedene Farben
Description	For easy and reliable marking of parking / storage areas etc., self-adhesive; Forklift-resistant and stable floor marking with outstanding adhesive strength, suitable for almost all industrial floors, removable without leaving residue	Beschreibung	zum schnellen und sicheren Kennzeichnen von Park-, Lager- oder Abstellflächen etc., selbstklebend; staplerfeste und formstabile Bodenmarkierung mit hoher Haltekraft, für nahezu alle Industrieböden geeignet, rückstandsfrei ablösbar
Material	Plastic PVC	Material	Kunststoff PVC
Color	Yellow, red, blue, green	Farbe	gelb, rot, blau, grün
Fastening	Self-adhesive surface on the backside	Befestigung	mit rückseitiger Selbstklebefläche
Pack Quantity	40 pieces	Liefereinheit	40 Stück
Tip	Suitable floor marking tape 50 see 0203T05015	Hinweis	passendes Bodenmarkierungsband 50 siehe 0203T05015

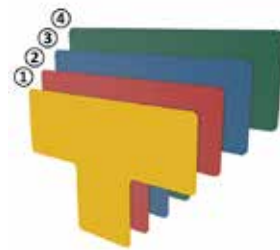
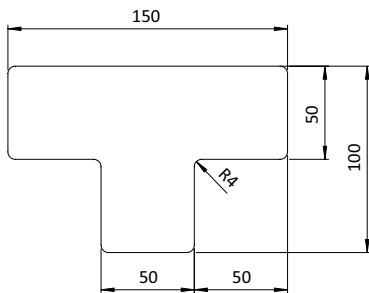

Fig. Abb.	Floor Marking T-shape 50 Bodenmarkierung T-Form 50	Color Farbe	Weight [g] Gewicht [g]	Part # Teil-Nr.
①		Yellow ≈ RAL 1018 <i>gelb</i>	7.0	0203HT05015
②		Red ≈ RAL 3020 <i>rot</i>	7.0	0203HT05031
③		Blue ≈ RAL 5017 <i>blau</i>	7.0	0203HT05055
④		Green ≈ RAL 6016 <i>grün</i>	7.0	0203HT05063



FLOOR MARKING T-SHAPE 75

BODENMARKIERUNG T-FORM 75

Model	Diverse colors	Ausführung	verschiedene Farben
Description	For easy and reliable marking of parking / storage areas etc., self-adhesive; Forklift-resistant and stable floor marking with outstanding adhesive strength, suitable for almost all industrial floors, removable without leaving residue	Beschreibung	zum schnellen und sicheren Kennzeichnen von Park-, Lager- oder Abstellflächen etc., selbstklebend; staplerfeste und formstabile Bodenmarkierung mit hoher Haltekraft, für nahezu alle Industrieböden geeignet, rückstandsfrei ablösbar
Material	Plastic PVC	Material	Kunststoff PVC
Color	Yellow, red, blue, green	Farbe	gelb, rot, blau, grün
Fastening	Self-adhesive surface on the backside	Befestigung	mit rückseitiger Selbstklebefläche
Pack Quantity	40 pieces	Liefereinheit	40 Stück
Tip	Suitable floor marking tape 75 see 0203T07515	Hinweis	passendes Bodenmarkierungsband 75 siehe 0203T07515

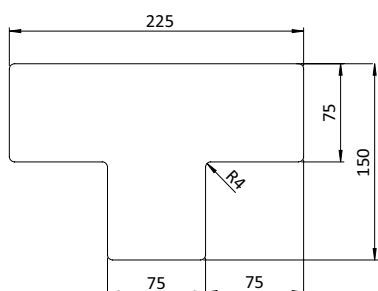

Fig. Abb.	Floor Marking T-shape 75 Bodenmarkierung T-Form 75	Color Farbe	Weight [g] Gewicht [g]	Part # Teil-Nr.
①		Yellow ≈ RAL 1018 <i>gelb</i>	15.0	0203HT07515
②		Red ≈ RAL 3020 <i>rot</i>	15.0	0203HT07531
③		Blue ≈ RAL 5017 <i>blau</i>	15.0	0203HT07555
④		Green ≈ RAL 6016 <i>grün</i>	15.0	0203HT07563



FLOOR MARKING L-SHAPE 50

BODENMARKIERUNG L-FORM 50

Model	Diverse colors	Ausführung	verschiedene Farben
Description	For easy and reliable marking of parking / storage areas etc., self-adhesive; Forklift-resistant and stable floor marking with outstanding adhesive strength, suitable for almost all industrial floors, removable without leaving residue	Beschreibung	zum schnellen und sicheren Kennzeichnen von Park-, Lager- oder Abstellflächen etc., selbstklebend; staplerfeste und formstabile Bodenmarkierung mit hoher Haltekraft, für nahezu alle Industrieböden geeignet, rückstandsfrei ablösbar
Material	Plastic PVC	Material	Kunststoff PVC
Color	Yellow, red, blue, green	Farbe	gelb, rot, blau, grün
Fastening	Self-adhesive surface on the backside	Befestigung	mit rückseitiger Selbstklebefläche
Pack Quantity	40 pieces	Liefereinheit	40 Stück
Tip	Suitable floor marking tape 50 see 0203T05015	Hinweis	passendes Bodenmarkierungsband 50 siehe 0203T05015

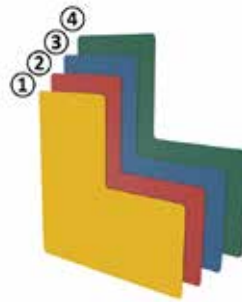
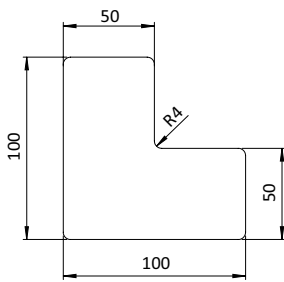

Fig. Abb.	Floor Marking L-shape 50 Bodenmarkierung L-Form 50	Color Farbe	Weight [g] Gewicht [g]	Part # Teil-Nr.
①		Yellow ≈ RAL 1018 <i>gelb</i>	5.0	0203HL05015
②		Red ≈ RAL 3020 <i>rot</i>	5.0	0203HL05031
③		Blue ≈ RAL 5017 <i>blau</i>	5.0	0203HL05055
④		Green ≈ RAL 6016 <i>grün</i>	5.0	0203HL05063



FLOOR MARKING L-SHAPE 75

BODENMARKIERUNG L-FORM 75

Model	Diverse colors	Ausführung	verschiedene Farben
Description	For easy and reliable marking of parking / storage areas etc., self-adhesive; Forklift-resistant and stable floor marking with outstanding adhesive strength, suitable for almost all industrial floors, removable without leaving residue	Beschreibung	zum schnellen und sicheren Kennzeichnen von Park-, Lager- oder Abstellflächen etc., selbstklebend; staplerfeste und formstabile Bodenmarkierung mit hoher Haltekraft, für nahezu alle Industrieböden geeignet, rückstandsfrei ablösbar
Material	Plastic PVC	Material	Kunststoff PVC
Color	Yellow, red, blue, green	Farbe	gelb, rot, blau, grün
Fastening	Self-adhesive surface on the backside	Befestigung	mit rückseitiger Selbstklebefläche
Pack Quantity	40 pieces	Liefereinheit	40 Stück
Tip	Suitable floor marking tape 75 see 0203T07515	Hinweis	passendes Bodenmarkierungsband 75 siehe 0203T07515

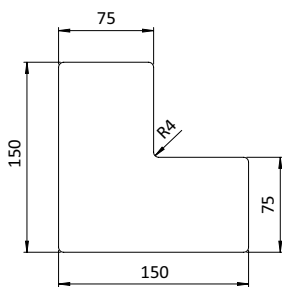

Fig. Abb.	Floor Marking L-shape 75 Bodenmarkierung L-Form 75	Color Farbe	Weight [g] Gewicht [g]	Part # Teil-Nr.
①		Yellow ≈ RAL 1018 <i>gelb</i>	12	0203HL07515
②		Red ≈ RAL 3020 <i>rot</i>	12	0203HL07531
③		Blue ≈ RAL 5017 <i>blau</i>	12	0203HL07555
④		Green ≈ RAL 6016 <i>grün</i>	12	0203HL07563



FLOOR MARKING I-SHAPE 50

BODENMARKIERUNG I-FORM 50

Model	Diverse colors	Ausführung	verschiedene Farben
Description	For easy and reliable marking of parking / storage areas etc., self-adhesive; Forklift-resistant and stable floor marking with outstanding adhesive strength, suitable for almost all industrial floors, removable without leaving residue	Beschreibung	zum schnellen und sicheren Kennzeichnen von Park-, Lager- oder Abstellflächen etc., selbstklebend; staplerfeste und formstabile Bodenmarkierung mit hoher Haltekraft, für nahezu alle Industrieböden geeignet, rückstandsfrei ablösbar
Material	Plastic PVC	Material	Kunststoff PVC
Color	Yellow, red, blue, green	Farbe	gelb, rot, blau, grün
Fastening	Self-adhesive surface on the backside	Befestigung	mit rückseitiger Selbstklebefläche
Pack Quantity	40 pieces	Liefereinheit	40 Stück
Tip	Suitable floor marking tape 50 see 0203T05015	Hinweis	passendes Bodenmarkierungsband 50 siehe 0203T05015

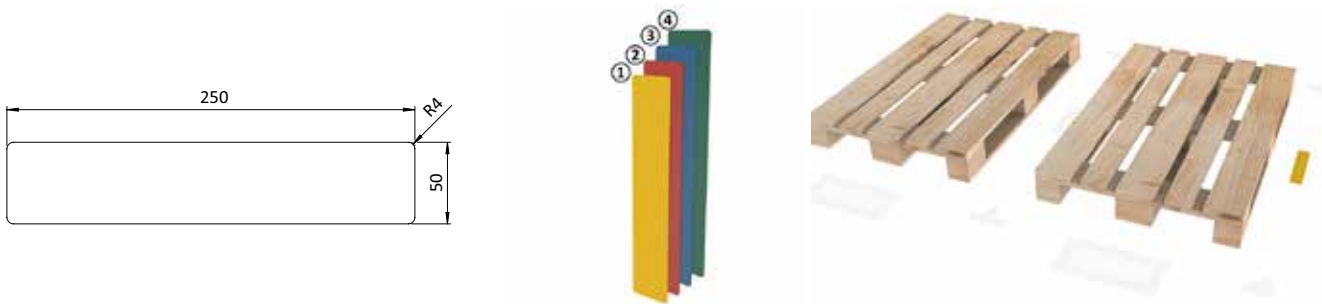

Fig. Abb.	Floor Marking I-shape 50 Bodenmarkierung I-Form 50	Color Farbe	Weight [g] Gewicht [g]	Part # Teil-Nr.
①		Yellow ≈ RAL 1018 <i>gelb</i>	9.0	0203HI05015
②		Red ≈ RAL 3020 <i>rot</i>	9.0	0203HI05031
③		Blue ≈ RAL 5017 <i>blau</i>	9.0	0203HI05055
④		Green ≈ RAL 6016 <i>grün</i>	9.0	0203HI05063



FLOOR MARKING I-SHAPE 75

BODENMARKIERUNG I-FORM 75

Model	Diverse colors	Ausführung	verschiedene Farben
Description	For easy and reliable marking of parking / storage areas etc., self-adhesive; Forklift-resistant and stable floor marking with outstanding adhesive strength, suitable for almost all industrial floors, removable without leaving residue	Beschreibung	zum schnellen und sicheren Kennzeichnen von Park-, Lager- oder Abstellflächen etc., selbstklebend; staplerfeste und formstabile Bodenmarkierung mit hoher Haltekraft, für nahezu alle Industrieböden geeignet, rückstandsfrei ablösbar
Material	Plastic PVC	Material	Kunststoff PVC
Color	Yellow, red, blue, green	Farbe	gelb, rot, blau, grün
Fastening	Self-adhesive surface on the backside	Befestigung	mit rückseitiger Selbstklebefläche
Pack Quantity	40 pieces	Liefereinheit	40 Stück
Tip	Suitable floor marking tape 75 see 0203T07515	Hinweis	passendes Bodenmarkierungsband 75 siehe 0203T07515

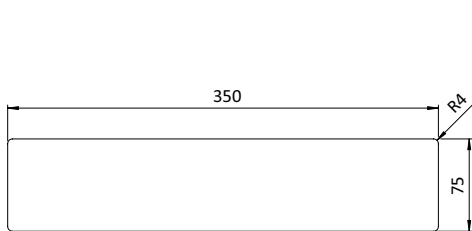

Fig. Abb.	Floor Marking I-shape 75 Bodenmarkierung I-Form 75	Color Farbe	Weight [g] Gewicht [g]	Part # Teil-Nr.
①		Yellow ≈ RAL 1018 <i>gelb</i>	18.0	0203HI07515
②		Red ≈ RAL 3020 <i>rot</i>	18.0	0203HI07531
③		Blue ≈ RAL 5017 <i>blau</i>	18.0	0203HI07555
④		Green ≈ RAL 6016 <i>grün</i>	18.0	0203HI07563



FLOOR MARKING FOOT SHAPE 90

BODENMARKIERUNG FUSS-FORM 90

Model	Diverse colors	Ausführung	verschiedene Farben
Description	For easy and reliable marking of parking / storage areas etc., self-adhesive; Forklift-resistant and stable floor marking with outstanding adhesive strength, suitable for almost all industrial floors, removable without leaving residue	Beschreibung	zum schnellen und sicheren Kennzeichnen von Park-, Lager- oder Abstellflächen etc., selbstklebend; staplerfeste und formstabile Bodenmarkierung mit hoher Haltekraft, für nahezu alle Industrieböden geeignet, rückstandsfrei ablösbar
Material	Plastic PVC	Material	Kunststoff PVC
Color	Yellow, red, blue, green	Farbe	gelb, rot, blau, grün
Fastening	Self-adhesive surface on the backside	Befestigung	mit rückseitiger Selbstklebefläche
Pack Quantity	40 pieces	Liefereinheit	40 Stück

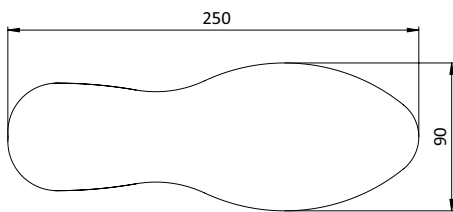

Fig. Abb.	Floor Marking Foot Shape 90 Bodenmarkierung Fuss-Form 90	Color Farbe	Weight [g] Gewicht [g]	Part # Teil-Nr.
①		Yellow ≈ RAL 1018 <i>gelb</i>	11.0	0203HF09015
②		Red ≈ RAL 3020 <i>rot</i>	11.0	0203HF09031
③		Blue ≈ RAL 5017 <i>blau</i>	11.0	0203HF09055
④		Green ≈ RAL 6016 <i>grün</i>	11.0	0203HF09063



FLOOR WINDOW DIN A5 - 5.8" X 8.3"

BODENFENSTER DIN A5

Model	Diverse colors	Ausführung	verschiedene Farben
Description	For easy and reliable marking of parking / storage areas etc., self-adhesive; Forklift-resistant and stable floor window with outstanding adhesive strength, suitable for almost all industrial floors, removable without leaving residue Scanner-compatible	Beschreibung	zum einfachen Kennzeichnen von Park-, Lager- oder Abstellflächen etc., selbstklebend; staplerfestes und formstabiles Bodenfenster mit hoher Haltekraft, für nahezu alle Industrieböden geeignet, rückstandsfrei ablösbar scannerlesbar
Material	Plastic PVC	Material	Kunststoff PVC
Color	Yellow, red, blue, green	Farbe	gelb, rot, blau, grün
Fastening	Self-adhesive strip on the backside	Befestigung	mit rückseitigem Selbstklebestreifen
Pack Quantity	10 pieces	Lieferinheit	10 Stück

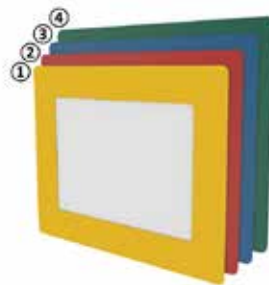
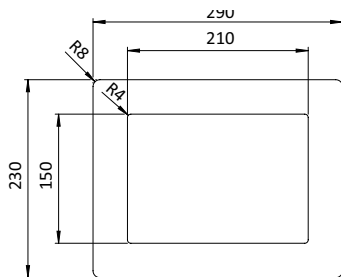

Fig. Abb.	Floor Window DIN A5 - 5.8" x 8.3" Bodenfenster DIN A5	Color Farbe	Weight [g] Gewicht [g]	Part # Teil-Nr.
①		Yellow ≈ RAL 1018 <i>gelb</i>	45.0	0203WRA515
②		Red ≈ RAL 3020 <i>rot</i>	45.0	0203WRA531
③		Blue ≈ RAL 5017 <i>blau</i>	45.0	0203WRA555
④		Green ≈ RAL 6016 <i>grün</i>	45.0	0203WRA563

FLOOR WINDOW 1/3 DIN A4 PORTRAIT - 8.3" X 3.9"

BODENFENSTER 1/3 DIN A4 HOCH

Model	Diverse colors	Ausführung	verschiedene Farben
Description	For easy and reliable marking of parking / storage areas etc., self-adhesive; Forklift-resistant and stable floor window with outstanding adhesive strength, suitable for almost all industrial floors, removable without leaving residue Scanner-compatible	Beschreibung	zum einfachen Kennzeichnen von Park-, Lager- oder Abstellflächen etc., selbstklebend; staplerfestes und formstabiles Bodenfenster mit hoher Haltekraft, für nahezu alle Industrieböden geeignet, rückstandsfrei ablösbar scannerlesbar
Material	Plastic PVC	Material	Kunststoff PVC
Color	Yellow, red, blue, green	Farbe	gelb, rot, blau, grün
Fastening	Self-adhesive strip on the backside	Befestigung	mit rückseitigem Selbstklebestreifen
Pack Quantity	10 pieces	Liefereinheit	10 Stück

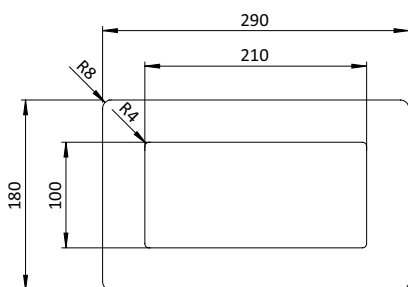

Fig. Abb.	Floor Window 1/3 DIN A4 Portrait - 8.3" x 3.9" Bodenfenster 1/3 DIN A4 hoch	Color Farbe	Weight [g] Gewicht [g]	Part # Teil-Nr.
①		Yellow ≈ RAL 1018 <i>gelb</i>	40.0	0203WRA1/315
②		Red ≈ RAL 3020 <i>rot</i>	40.0	0203WRA1/331
③		Blue ≈ RAL 5017 <i>blau</i>	40.0	0203WRA1/355
④		Green ≈ RAL 6016 <i>grün</i>	40.0	0203WRA1/363

FLOOR WINDOW DIN A4 - 8.3" X 11.7"

BODENFENSTER DIN A4

Model	Diverse colors	Ausführung	verschiedene Farben
Description	For easy and reliable marking of parking / storage areas etc., self-adhesive; Forklift-resistant and stable floor window with outstanding adhesive strength, suitable for almost all industrial floors, removable without leaving residue Scanner-compatible	Beschreibung	zum einfachen Kennzeichnen von Park-, Lager- oder Abstellflächen etc., selbstklebend; staplerfestes und formstabiles Bodenfenster mit hoher Haltekraft, für nahezu alle Industrieböden geeignet, rückstandsfrei ablösbar scannerlesbar
Material	Plastic PVC	Material	Kunststoff PVC
Color	Yellow, red, blue, green	Farbe	gelb, rot, blau, grün
Fastening	Self-adhesive strip on the backside	Befestigung	mit rückseitigem Selbstklebestreifen
Pack Quantity	10 pieces	Lieferinheit	10 Stück

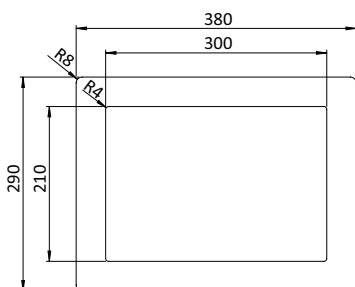

Fig. Abb.	Floor Window DIN A4 - 8.3" x 11.7" Bodenfenster DIN A4	Color Farbe	Weight [g] Gewicht [g]	Part # Teil-Nr.
①		Yellow ≈ RAL 1018 <i>gelb</i>	70.0	0203WRA415
②		Red ≈ RAL 3020 <i>rot</i>	70.0	0203WRA431
③		Blue ≈ RAL 5017 <i>blau</i>	70.0	0203WRA455
④		Green ≈ RAL 6016 <i>grün</i>	70.0	0203WRA463

FLOOR WINDOW 1/2 DIN A4 LANDSCAPE - 11.7" X 4.1" BODENFENSTER 1/2 DIN A4 QUER

Model	Diverse colors	Ausführung	verschiedene Farben
Description	For easy and reliable marking of parking / storage areas etc., self-adhesive; Forklift-resistant and stable floor window with outstanding adhesive strength, suitable for almost all industrial floors, removable without leaving residue Scanner-compatible	Beschreibung	zum einfachen Kennzeichnen von Park-, Lager- oder Abstellflächen etc., selbstklebend; staplerfestes und formstabilen Bodenfenster mit hoher Haltekraft, für nahezu alle Industrieböden geeignet, rückstandsfrei ablösbar scannerlesbar
Material	Plastic PVC	Material	Kunststoff PVC
Color	Yellow, red, blue, green	Farbe	gelb, rot, blau, grün
Fastening	Self-adhesive strip on the backside	Befestigung	mit rückseitigem Selbstklebestreifen
Pack Quantity	10 pieces	Liefereinheit	10 Stück

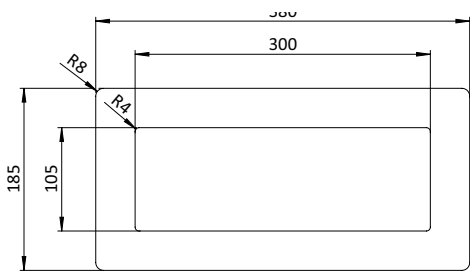

Fig. Abb.	Floor Window 1/2 DIN A4 Landscape - 11.7" x 4.1" Bodenfenster 1/2 DIN A4 quer	Color Farbe	Weight [g] Gewicht [g]	Part # Teil-Nr.
①		Yellow ≈ RAL 1018 <i>gelb</i>	50.0	0203WRA1/215
②		Red ≈ RAL 3020 <i>rot</i>	50.0	0203WRA1/231
③		Blue ≈ RAL 5017 <i>blau</i>	50.0	0203WRA1/255
④		Green ≈ RAL 6016 <i>grün</i>	50.0	0203WRA1/263



simply
practical

FLOOR SIGNS BODENSCHILDER

FATH®
COMPONENTS



HIGHLY EFFECTIVE SIGNALING
OTHER PICTOGRAMS UPON REQUEST
GROSSE SIGNALWIRKUNG
WEITERE PIKTOGRAMME AUF ANFRAGE!

SAFE AND LEAN: HIGHLIGHT DANGER ZONES EASILY WITH SELF-ADHESIVE FATH'S FLOOR SIGNS SICHER UND LEAN: GEFAHRENZONEN EINFACH MARKIEREN MIT DEN SELBSTKLEBENDEN FATH BODENSCHILDERN

Floor signs for rapid, reliable labeling

- Pictograms as per ASR standards
- Outstanding adhesive strength
- Forklift-resilient and extremely long-lasting
- Suitable for almost all industrial floors
- Prohibition signs, mandatory signs, warning and information signs
- Highly effective signaling

- **DURABLE**
- **STANDARD-COMPLIANT**

Bodenschilder für die schnelle und sichere Kennzeichnung

- *Piktogramme nach ASR-Norm*
- *Hohe Haftkraft*
- *Staplerfest und äußerst langlebig*
- *Für nahezu alle Industrieböden geeignet*
- *Verbotsschilder, Gebotsschilder, Warn- und Hinweisschilder*
- *Große Signalwirkung*

- **LANGLEBIG**
- **NORMGERECHT**



COMPLY WITH ASR STANDARDS WITH FATH FLOOR SIGNS ASR-NORM EINHALTEN MIT FATH BODENSCHILDERN

The pictograms on **FATH's** floor signs are designed in full compliance with ASR standards. **FATH's** floor signs are 450 mm in size, guaranteeing that symbols are seen from a distance – viewing from a forklift, for example. This means they comply with the German Technical Workplace Regulations (ASR) and meet the requirements specified in the German Ordinance on Workplaces (ArbStättV), which serve to ensure safety and health protection for employees.

*Die Piktogramme der **FATH** Bodenschilder sind nach der geltenden ASR-Norm gestaltet. Durch die Schildergröße von 450 mm ist gewährleistet, dass die Symbole bereits aus einer gewissen Entfernung gesehen werden, beispielsweise vom Gabelstapler aus. Damit halten Sie die Technischen Regeln für Arbeitsstätten (ASR) ein und erfüllen die Anforderungen der Arbeitsstättenverordnung (ArbStättV), die der Sicherheit und dem Gesundheitsschutz der Beschäftigten dienen.*

FATH'S FLOOR SIGNS: SELF-ADHESIVE AND FORKLIFT-RESILIENT FATH BODENSCHILDER: SELBSTKLEBEND UND STAPLERFEST

Self-adhesive, dimensionally stable **FATH** floor signs are easily affixed to the floor, can be driven over immediately and are easy to clean. They are suitable for virtually all industrial floors and surfaces. Unlike with paint or lacquer markings, there are no long drying times and no unpleasant odors. Thanks to the adhesive applied across their entire rear surface, these floor signs even adhere to problematic surfaces permanently.

Die selbstklebenden, formstabilen FATH Bodenschilder werden einfach auf den Boden aufgeklebt, sind sofort befahrbar und leicht zu reinigen. Sie eignen sich für nahezu alle Industrieböden und Untergründe. Im Gegensatz zu Markierungen mittels Lack oder Farbe, entfallen lange Trocknungszeiten und es entsteht keine Geruchsbelästigung. Durch den vollflächig rückseitig aufgetragenen Kleber haften die Bodenschilder dauerhaft auch auf problematischen Untergründen.

NEW PRINTING METHOD PROTECTS AGAINST SCRATCHING NEUES DRUCKKONZEPT SCHÜTZT VOR VERKRATZEN

What makes **FATH's** floor signs so special: The pictogram's color print is applied to the inside instead of the outer surface and is then covered with a transparent protective film. This means that the image is fully enclosed between the film and the adhesive and is thus permanently protected against wear and scratching, even after long use and heavy exposure to the surface. The hard-wearing plastic surface suitable for industrial use can withstand high loads, such as industrial trucks driving over it.

Das Besondere an den FATH Bodenschildern: Der Farbdruck der Piktogramme ist statt auf der Oberfläche auf der Innenseite angebracht und wird von einer klarsichtigen Folie abgedeckt. Dadurch wird das Bild vollständig zwischen Folie und Kleber eingeschlossen und ist somit dauerhaft vor Abnutzung und Verkratzen geschützt – auch bei langem Einsatz und starker Beanspruchung der Oberfläche. Die industrietaugliche, strapazierfähige Kunststoffoberfläche hält hohen Belastungen, wie dem Überfahren von Flurförderfahrzeugen, stand.

FULL FLEXIBILITY FOR REORGANIZATION VOLLE FLEXIBILITÄT BEI UMSTRUKTURIERUNGEN

These self-adhesive floor signs can be detached from the floor without leaving residue if reorganization or facility extensions are planned. The floor remains intact after signs are removed since no chemicals or acid-based substances are required to remove them. Buildings, warehouses, and surfaces can be labeled permanently or temporarily without causing any damage. That is lean too!

Die selbstklebenden Bodenschilder können rückstandsfrei vom Boden abgelöst werden, wenn Umstrukturierungen oder Betriebserweiterungen anstehen. Nach dem Ablösen der Schilder bleibt der Boden intakt, da keine Chemie oder säurehaltigen Substanzen für die Entfernung nötig sind. Gebäude, Lagerhallen und Flächen können temporär oder permanent ohne Folgeschäden gekennzeichnet werden. Auch das ist lean!

VERSIONS AUSFÜHRUNGEN

All standard signs in the following categories are available.

Erhältlich sind alle gängigen Schilder der folgenden Kategorien.



You would like to know more about the FATH Floor Signs?

floor-sign.fath24.com

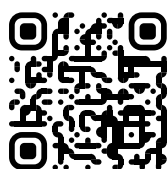

Sie möchten die FATH Bodenschilder besser kennen lernen?

bodenschild.fath24.de

NO FORKLIFT TRAFFIC FLOOR SIGN

FÜR FLURFÖRDERZEUGE VERBOTEN BODENSCHILD

Model	Prohibitive Sign	Ausführung	Verbotsschild
Description	For fast and reliable safety marking according to ASR A1.3 / DIN EN ISO 7010, self-adhesive; Easy recognition from long distance; Forklift-resistant and slip-proof floor sign with outstanding adhesive strength, suitable for almost all industrial floors, removable without leaving residue	Beschreibung	für die schnelle und zuverlässige Sicherheitskennzeichnung gemäß ASR A1.3 / DIN EN ISO 7010, selbstklebend; sehr gute Erkennbarkeit aus großer Entfernung; staplerfestes und trittsicheres Bodenschild mit hoher Haltekraft, für nahezu alle Industrieböden geeignet, rückstandsfrei ablösbar
Material	Plastic PVC	Material	Kunststoff PVC
Color	Red / white / black	Farbe	rot / weiß / schwarz
Fastening	Self-adhesive surface on the backside	Befestigung	mit rückseitiger Selbstklebefläche
Pack Quantity	1 piece	Liefereinheit	1 Stück



No Forklift Traffic Floor Sign
 Für Flurförderzeuge verboten Bodenschild

Weight [g]
 Gewicht [g]

Part #
 Teil-Nr.

174.0

0203SP01



NO STOPPING FLOOR SIGN

HALTEVERBOT BODENSCHILD

<p>Model Prohibitive Sign</p> <p>Description For fast and reliable safety marking according to ASR A1.3 / DIN EN ISO 7010, self-adhesive; Easy recognition from long distance; Forklift-resistant and slip-proof floor sign with outstanding adhesive strength, suitable for almost all industrial floors, removable without leaving residue</p> <p>Material Plastic PVC</p> <p>Color Red / blue</p> <p>Fastening Self-adhesive surface on the backside</p> <p>Pack Quantity 1 piece</p>	<p>Ausführung Verbotsschild</p> <p>Beschreibung für die schnelle und zuverlässige Sicherheitskennzeichnung gemäß ASR A1.3 / DIN EN ISO 7010, selbstklebend; sehr gute Erkennbarkeit aus großer Entfernung; staplerfestes und trittsicheres Bodenschild mit hoher Haltekraft, für nahezu alle Industrieböden geeignet, rückstandsfrei ablösbar</p> <p>Material Kunststoff PVC</p> <p>Farbe rot / blau</p> <p>Befestigung mit rückseitiger Selbstklebefläche</p> <p>Liefereinheit 1 Stück</p>
--	---

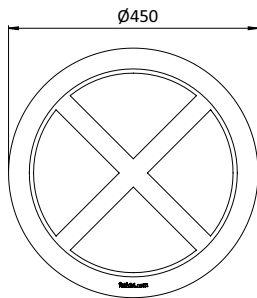

No Stopping Floor Sign
 Halteverbot Bodenschild

Weight [g]
 Gewicht [g]

Part #
 Teil-Nr.

174.0

0203SP02



NO ENTRY FLOOR SIGN

VERBOT DER EINFAHRT BODENSCHILD

Model	Prohibitive Sign	Ausführung	Verbotsschild
Description	For fast and reliable safety marking according to ASR A1.3 / DIN EN ISO 7010, self-adhesive; Easy recognition from long distance; Forklift-resistant and slip-proof floor sign with outstanding adhesive strength, suitable for almost all industrial floors, removable without leaving residue	Beschreibung	für die schnelle und zuverlässige Sicherheitskennzeichnung gemäß ASR A1.3 / DIN EN ISO 7010, selbstklebend; sehr gute Erkennbarkeit aus großer Entfernung; staplerfestes und trittsicheres Bodenschild mit hoher Haltekraft, für nahezu alle Industrieböden geeignet, rückstandsfrei ablösbar
Material	Plastic PVC	Material	Kunststoff PVC
Color	Red / white / black	Farbe	rot / weiß / schwarz
Fastening	Self-adhesive surface on the backside	Befestigung	mit rückseitiger Selbstklebefläche
Pack Quantity	1 piece	Liefereinheit	1 Stück

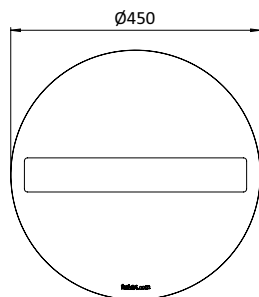

No Entry Floor Sign
 Verbot der Einfahrt Bodenschild

Weight [g]
 Gewicht [g]

Part #
 Teil-Nr.

174.0

0203SP03



NO SMOKING FLOOR SIGN

RAUCHEN VERBOTEN BODENSCHILD

Model	Prohibitive Sign	Ausführung	Verbotsschild
Description	For fast and reliable safety marking according to ASR A1.3 / DIN EN ISO 7010, self-adhesive; Easy recognition from long distance; Forklift-resistant and slip-proof floor sign with outstanding adhesive strength, suitable for almost all industrial floors, removable without leaving residue	Beschreibung	für die schnelle und zuverlässige Sicherheitskennzeichnung gemäß ASR A1.3 / DIN EN ISO 7010, selbstklebend; sehr gute Erkennbarkeit aus großer Entfernung; staplerfestes und trittsicheres Bodenschild mit hoher Haltekraft, für nahezu alle Industrieböden geeignet, rückstandsfrei ablösbar
Material	Plastic PVC	Material	Kunststoff PVC
Color	Red / white / black	Farbe	rot / weiß / schwarz
Fastening	Self-adhesive surface on the backside	Befestigung	mit rückseitiger Selbstklebefläche
Pack Quantity	1 piece	Liefereinheit	1 Stück

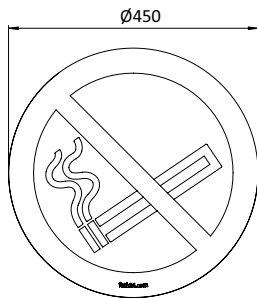

No Smoking Floor Sign
 Rauchen verboten Bodenschild

Weight [g]
 Gewicht [g]

Part #
 Teil-Nr.

174.0

0203SP04



NO PEDESTRIAN FLOOR SIGN

FÜR FUSSGÄNGER VERBOTEN BODENSCHILD

Model	Prohibitive Sign	Ausführung	Verbotsschild
Description	For fast and reliable safety marking according to ASR A1.3 / DIN EN ISO 7010, self-adhesive; Easy recognition from long distance; Forklift-resistant and slip-proof floor sign with outstanding adhesive strength, suitable for almost all industrial floors, removable without leaving residue	Beschreibung	für die schnelle und zuverlässige Sicherheitskennzeichnung gemäß ASR A1.3 / DIN EN ISO 7010, selbstklebend; sehr gute Erkennbarkeit aus großer Entfernung; staplerfestes und trittsicheres Bodenschild mit hoher Haltekraft, für nahezu alle Industrieböden geeignet, rückstandsfrei ablösbar
Material	Plastic PVC	Material	Kunststoff PVC
Color	Red / white / black	Farbe	rot / weiß / schwarz
Fastening	Self-adhesive surface on the backside	Befestigung	mit rückseitiger Selbstklebefläche
Pack Quantity	1 piece	Liefereinheit	1 Stück

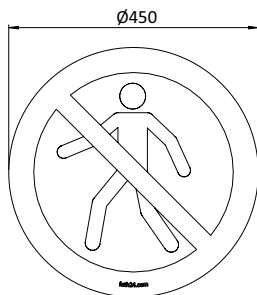

No Pedestrian Floor Sign
 Für Fußgänger verboten Bodenschild

Weight [g]
 Gewicht [g]

Part #
 Teil-Nr.

174.0

0203SP05



WEAR HEARING PROTECTION FLOOR SIGN

GEHÖRSCHUTZ TRAGEN BODENSCHILD

Model	Mandatory Sign	Ausführung	Gebotsschild
Description	For fast and reliable safety marking according to ASR A1.3 / DIN EN ISO 7010, self-adhesive; Easy recognition from long distance; Forklift-resistant and slip-proof floor sign with outstanding adhesive strength, suitable for almost all industrial floors, removable without leaving residue	Beschreibung	für die schnelle und zuverlässige Sicherheitskennzeichnung gemäß ASR A1.3 / DIN EN ISO 7010, selbstklebend; sehr gute Erkennbarkeit aus großer Entfernung; staplerfestes und trittsicheres Bodenschild mit hoher Haltekraft, für nahezu alle Industrieböden geeignet, rückstandsfrei ablösbar
Material	Plastic PVC	Material	Kunststoff PVC
Color	Blue / white	Farbe	blau / weiß
Fastening	Self-adhesive surface on the backside	Befestigung	mit rückseitiger Selbstklebefläche
Pack Quantity	1 piece	Liefereinheit	1 Stück

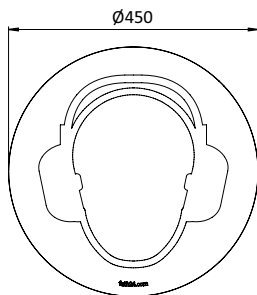

Wear Hearing Protection Floor Sign
 Gehörschutz tragen Bodenschild

Weight [g]
 Gewicht [g]

Part #
 Teil-Nr.

174.0

0203SM01



SAFETY VEST REQUIRED FLOOR SIGN

WARNWESTE TRAGEN BODENSCHILD

Model	Mandatory Sign	Ausführung	Gebotsschild
Description	For fast and reliable safety marking according to ASR A1.3 / DIN EN ISO 7010, self-adhesive; Easy recognition from long distance; Forklift-resistant and slip-proof floor sign with outstanding adhesive strength, suitable for almost all industrial floors, removable without leaving residue	Beschreibung	für die schnelle und zuverlässige Sicherheitskennzeichnung gemäß ASR A1.3 / DIN EN ISO 7010, selbstklebend; sehr gute Erkennbarkeit aus großer Entfernung; staplerfestes und trittsicheres Bodenschild mit hoher Haltekraft, für nahezu alle Industrieböden geeignet, rückstandsfrei ablösbar
Material	Plastic PVC	Material	Kunststoff PVC
Color	Blue / white	Farbe	blau / weiß
Fastening	Self-adhesive surface on the backside	Befestigung	mit rückseitiger Selbstklebefläche
Pack Quantity	1 piece	Liefereinheit	1 Stück

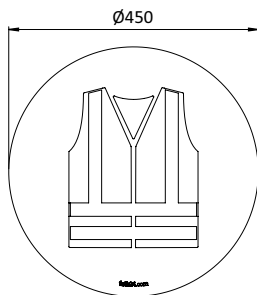

Safety Vest Required Floor Sign
 Warnweste tragen Bodenschild

Weight [g]
 Gewicht [g]

Part #
 Teil-Nr.

174.0

0203SM02



TRAFFIC ARROW FLOOR SIGN

RICHTUNGSHINWEIS BODENSCHILD

Model	Mandatory Sign	Ausführung	Gebotsschild
Description	For fast and reliable safety marking according to ASR A1.3 / DIN EN ISO 7010, self-adhesive; Easy recognition from long distance; Forklift-resistant and slip-proof floor sign with outstanding adhesive strength, suitable for almost all industrial floors, removable without leaving residue	Beschreibung	für die schnelle und zuverlässige Sicherheitskennzeichnung gemäß ASR A1.3 / DIN EN ISO 7010, selbstklebend; sehr gute Erkennbarkeit aus großer Entfernung; staplerfestes und trittsicheres Bodenschild mit hoher Haltekraft, für nahezu alle Industrieböden geeignet, rückstandsfrei ablösbar
Material	Plastic PVC	Material	Kunststoff PVC
Color	Blue / white	Farbe	blau / weiß
Fastening	Self-adhesive surface on the backside	Befestigung	mit rückseitiger Selbstklebefläche
Pack Quantity	1 piece	Liefereinheit	1 Stück

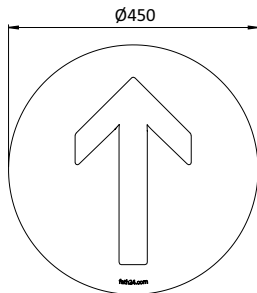

Traffic Arrow Floor Sign
 Richtungshinweis Bodenschild

Weight [g]
 Gewicht [g]

Part #
 Teil-Nr.

174.0

0203SM03



HARD HAT AREA FLOOR SIGN

KOPFSCHUTZ BENUTZEN BODENSCHILD

Model	Mandatory Sign	Ausführung	Gebotsschild
Description	For fast and reliable safety marking according to ASR A1.3 / DIN EN ISO 7010, self-adhesive; Easy recognition from long distance; Forklift-resistant and slip-proof floor sign with outstanding adhesive strength, suitable for almost all industrial floors, removable without leaving residue	Beschreibung	für die schnelle und zuverlässige Sicherheitskennzeichnung gemäß ASR A1.3 / DIN EN ISO 7010, selbstklebend; sehr gute Erkennbarkeit aus großer Entfernung; staplerfestes und trittsicheres Bodenschild mit hoher Haltekraft, für nahezu alle Industrieböden geeignet, rückstandsfrei ablösbar
Material	Plastic PVC	Material	Kunststoff PVC
Color	Blue / white	Farbe	blau / weiß
Fastening	Self-adhesive surface on the backside	Befestigung	mit rückseitiger Selbstklebefläche
Pack Quantity	1 piece	Liefereinheit	1 Stück

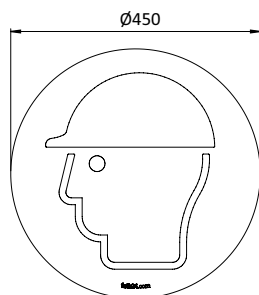

Hard Hat Area Floor Sign
 Kopfschutz benutzen Bodenschild

Weight [g]
 Gewicht [g]

Part #
 Teil-Nr.

174.0

0203SM04



SAFETY GLASSES REQUIRED FLOOR SIGN

AUGENSCHUTZ BENUTZEN BODENSCHILD

Model	Mandatory Sign	Ausführung	Gebotsschild
Description	For fast and reliable safety marking according to ASR A1.3 / DIN EN ISO 7010, self-adhesive; Easy recognition from long distance; Forklift-resistant and slip-proof floor sign with outstanding adhesive strength, suitable for almost all industrial floors, removable without leaving residue	Beschreibung	für die schnelle und zuverlässige Sicherheitskennzeichnung gemäß ASR A1.3 / DIN EN ISO 7010, selbstklebend; sehr gute Erkennbarkeit aus großer Entfernung; staplerfestes und trittsicheres Bodenschild mit hoher Haltekraft, für nahezu alle Industrieböden geeignet, rückstandsfrei ablösbar
Material	Plastic PVC	Material	Kunststoff PVC
Color	Blue / white	Farbe	blau / weiß
Fastening	Self-adhesive surface on the backside	Befestigung	mit rückseitiger Selbstklebefläche
Pack Quantity	1 piece	Liefereinheit	1 Stück

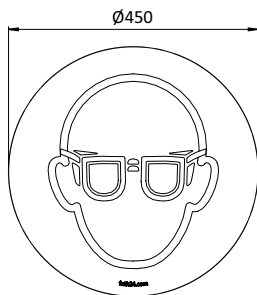

Safety Glasses Required Floor Sign
 Augenschutz benutzen Bodenschild

Weight [g]
 Gewicht [g]

Part #
 Teil-Nr.

174.0

0203SM05



SAFETY SHOES REQUIRED FLOOR SIGN

FUSSSCHUTZ BENUTZEN BODENSCHILD

Model	Mandatory Sign	Ausführung	Gebotsschild
Description	For fast and reliable safety marking according to ASR A1.3 / DIN EN ISO 7010, self-adhesive; Easy recognition from long distance; Forklift-resistant and slip-proof floor sign with outstanding adhesive strength, suitable for almost all industrial floors, removable without leaving residue	Beschreibung	für die schnelle und zuverlässige Sicherheitskennzeichnung gemäß ASR A1.3 / DIN EN ISO 7010, selbstklebend; sehr gute Erkennbarkeit aus großer Entfernung; staplerfestes und trittsicheres Bodenschild mit hoher Haltekraft, für nahezu alle Industrieböden geeignet, rückstandsfrei ablösbar
Material	Plastic PVC	Material	Kunststoff PVC
Color	Blue / white	Farbe	blau / weiß
Fastening	Self-adhesive surface on the backside	Befestigung	mit rückseitiger Selbstklebefläche
Pack Quantity	1 piece	Liefereinheit	1 Stück

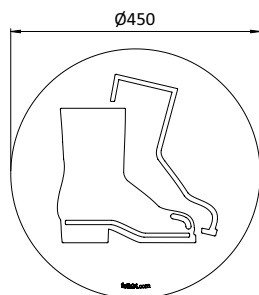

Safety Shoes Required Floor Sign
 Fußschutz benutzen Bodenschild

Weight [g]
 Gewicht [g]

Part #
 Teil-Nr.

174.0

0203SM06



PEDESTRIAN ROUTE FLOOR SIGN

FUSSGÄNGERWEG BENUTZEN BODENSCHILD

<p>Model Mandatory Sign</p> <p>Description For fast and reliable safety marking according to ASR A1.3 / DIN EN ISO 7010, self-adhesive; Easy recognition from long distance; Forklift-resistant and slip-proof floor sign with outstanding adhesive strength, suitable for almost all industrial floors, removable without leaving residue</p> <p>Material Plastic PVC</p> <p>Color Blue / white</p> <p>Fastening Self-adhesive surface on the backside</p> <p>Pack Quantity 1 piece</p>	<p>Ausführung Gebotsschild</p> <p>Beschreibung für die schnelle und zuverlässige Sicherheitskennzeichnung gemäß ASR A1.3 / DIN EN ISO 7010, selbstklebend; sehr gute Erkennbarkeit aus großer Entfernung; staplerfestes und trittsicheres Bodenschild mit hoher Haltekraft, für nahezu alle Industrieböden geeignet, rückstandsfrei ablösbar</p> <p>Material Kunststoff PVC</p> <p>Farbe blau / weiß</p> <p>Befestigung mit rückseitiger Selbstklebefläche</p> <p>Liefereinheit 1 Stück</p>
--	---

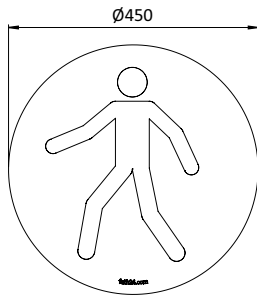

Pedestrian Route Floor Sign
 Fußgängerweg benutzen Bodenschild

Weight [g]
 Gewicht [g]

Part #
 Teil-Nr.

174.0

0203SM07



DRIVE SLOWLY FLOOR SIGN

SCHRITT FAHREN BODENSCHILD

Model	Mandatory Sign	Ausführung	Gebotsschild
Description	For fast and reliable safety marking according to ASR A1.3 / DIN EN ISO 7010, self-adhesive; Easy recognition from long distance; Forklift-resistant and slip-proof floor sign with outstanding adhesive strength, suitable for almost all industrial floors, removable without leaving residue	Beschreibung	für die schnelle und zuverlässige Sicherheitskennzeichnung gemäß ASR A1.3 / DIN EN ISO 7010, selbstklebend; sehr gute Erkennbarkeit aus großer Entfernung; staplerfestes und trittsicheres Bodenschild mit hoher Haltekraft, für nahezu alle Industrieböden geeignet, rückstandsfrei ablösbar
Material	Plastic PVC	Material	Kunststoff PVC
Color	Blue / white	Farbe	blau / weiß
Fastening	Self-adhesive surface on the backside	Befestigung	mit rückseitiger Selbstklebefläche
Pack Quantity	1 piece	Liefereinheit	1 Stück

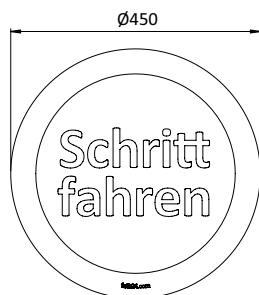

Drive Slowly Floor Sign
 Schritt fahren Bodenschild

Weight [g]
 Gewicht [g]

Part #
 Teil-Nr.

174.0

0203SM08



STOP FLOOR SIGN

STOP BODENSCHILD

Model	Warning and Notice Sign	Ausführung	Warn- und Hinweisschild
Description	For fast and reliable safety marking according to ASR A1.3 / DIN EN ISO 7010, self-adhesive; Easy recognition from long distance; Forklift-resistant and slip-proof floor sign with outstanding adhesive strength, suitable for almost all industrial floors, removable without leaving residue	Beschreibung	für die schnelle und zuverlässige Sicherheitskennzeichnung gemäß ASR A1.3 / DIN EN ISO 7010, selbstklebend; sehr gute Erkennbarkeit aus großer Entfernung; staplerfestes und trittsicheres Bodenschild mit hoher Haltekraft, für nahezu alle Industrieböden geeignet, rückstandsfrei ablösbar
Material	Plastic PVC	Material	Kunststoff PVC
Color	Red / white	Farbe	rot / weiß
Fastening	Self-adhesive surface on the backside	Befestigung	mit rückseitiger Selbstklebefläche
Pack Quantity	1 piece	Liefereinheit	1 Stück

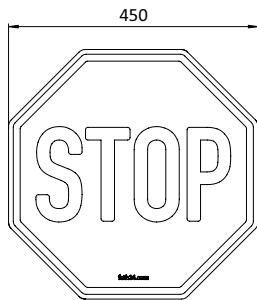

Stop Floor Sign
 Stop Bodenschild

Weight [g]
 Gewicht [g]

Part #
 Teil-Nr.

	184.0	0203SW01
--	-------	----------



CAUTION FORKLIFT ZONE FLOOR SIGN

WARNUNG VOR FLURFÖRDERZEUGEN BODENSCHILD

Model	Warning and Notice Sign	Ausführung	Warn- und Hinweisschild
Description	For fast and reliable safety marking according to ASR A1.3 / DIN EN ISO 7010, self-adhesive; Easy recognition from long distance; Forklift-resistant and slip-proof floor sign with outstanding adhesive strength, suitable for almost all industrial floors, removable without leaving residue	Beschreibung	für die schnelle und zuverlässige Sicherheitskennzeichnung gemäß ASR A1.3 / DIN EN ISO 7010, selbstklebend; sehr gute Erkennbarkeit aus großer Entfernung; staplerfestes und trittsicheres Bodenschild mit hoher Haltekraft, für nahezu alle Industrieböden geeignet, rückstandsfrei ablösbar
Material	Plastic PVC	Material	Kunststoff PVC
Color	Yellow / black	Farbe	gelb / schwarz
Fastening	Self-adhesive surface on the backside	Befestigung	mit rückseitiger Selbstklebefläche
Pack Quantity	1 piece	Liefereinheit	1 Stück

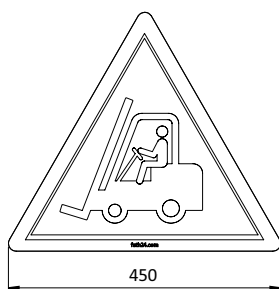

Caution Forklift Zone Floor Sign
 Warnung vor Flurförderzeugen Bodenschild

Weight [g]
 Gewicht [g]

Part #
 Teil-Nr.

	104.0	0203SW02
--	-------	----------



STICKERS AUFKLEBER

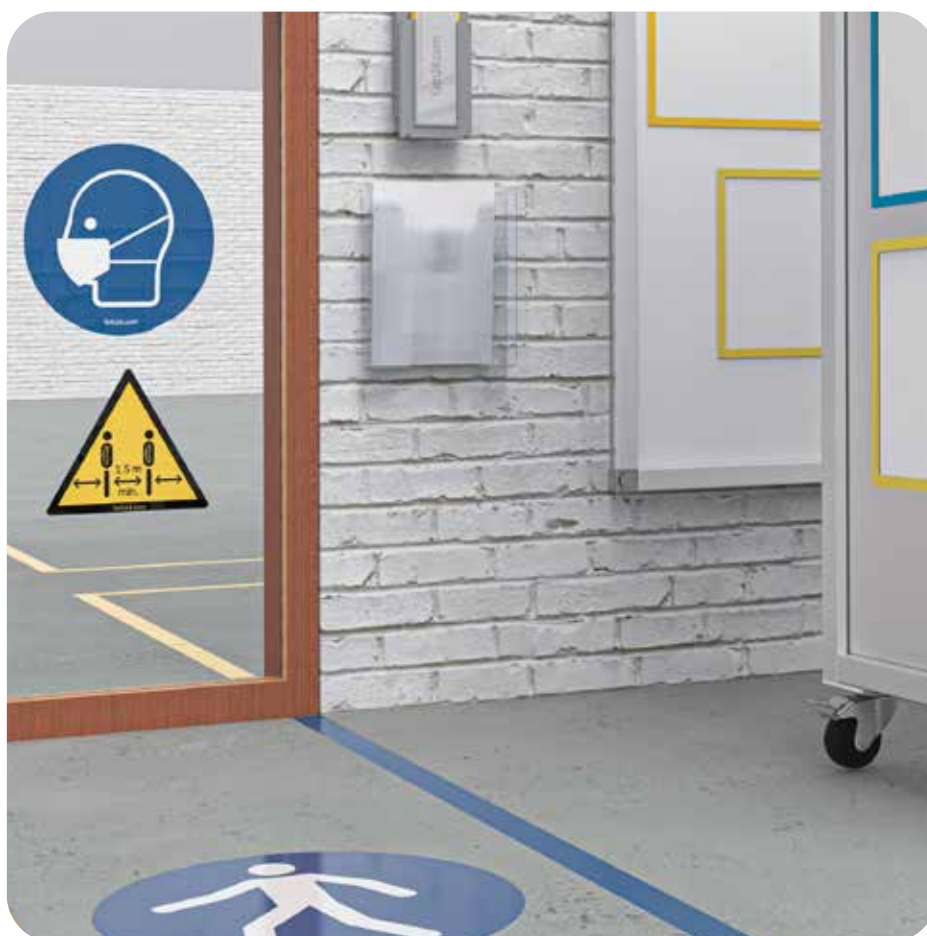

Container Labelings
Behälterkennzeichnungen 1

Shelf Labelings
Regalkennzeichnungen 2

Floor Markings
Bodenmarkierungen 3

**Stickers
Aufkleber 4**

Inserting Systems
Einstecksysteme 5

Visual Boards
Visual Boards 6

MATERIAL FLOW MATERIALFLUSS

Material Transport
Materialtransport 7

Material Supply
Materialbereitstellung 8

	Warning Slippery Surface Floor Sign <i>Warnung vor Rutschgefahr Bodenschild</i>	113
	No Handshake Sticker <i>Händeschütteln verboten Aufkleber</i>	114
	No Entry Sticker <i>Verbot der Einfahrt Aufkleber</i>	115
	Face Mask Sticker <i>Maske benutzen Aufkleber</i>	116
	Face Protection Sticker <i>Gesichtschutz benutzen Aufkleber</i>	117
	Disinfect Hands Sticker <i>Hände desinfizieren Aufkleber</i>	118
	Wash Hands Sticker <i>Hände waschen Aufkleber</i>	119
	Traffic Arrow Sticker <i>Richtungshinweis Aufkleber</i>	120
	Safe Distance Sticker <i>Sicherheitsabstand Aufkleber</i>	121

simply
practical

STICKERS AUFKLEBER

FATH[®]
COMPONENTS



REPOSITIONABLE
REPOSITIONIERBAR

VISUALIZE PROTECTION MEASURES: FATH INFORMATION STICKERS FOR MULTIPLE SURFACES SCHUTZMASSNAHMEN VISUALISIEREN: FATH AUFKLEBER FÜR UNTERSCHIEDLICHEN OBERFLÄCHEN

The high-quality **FATH** stickers for walls and doors provide clear indications and protection for the observance of distance regulation and hygiene measures.

- Self-adhesive on all smooth surfaces
- 300 mm diameter for extraordinary signal effect
- Can be removed without residue from almost all surfaces
- Reusable

With the **FATH** prohibition, mandatory, warning and notice sticker you inform your employees, customers and visitors in all areas and thus create a safe environment through clear marking

- **HIGHLY VISIBLE**
- **REPOSITIONABLE**

Die hochwertigen **FATH** Aufkleber für Wände und Türen bieten eindeutige Hinweise und Schutz für die Einhaltung der Abstandsregelung und Hygienemaßnahmen.

- **Selbstklebend auf allen glatten Untergründen**
- **300 mm Durchmesser für hervorragende Signalwirkung**
- **Rückstandsfrei entfernbar von nahezu allen Flächen**
- **Wiederverwendbar**

Mit den **FATH** Verbots-, Gebots-, Warn- und Hinweisaufkleber informieren Sie Ihre Mitarbeiter, Kunden, und Besucher in allen Bereichen und schaffen dadurch eine eindeutige Kennzeichnung für ein sicheres Umfeld.

- **DEUTLICH SICHTBAR**
- **REPOSITIONIERBAR**

SAFETY MARKING ACCORDING TO ASR A1.3 / DIN EN ISO 7010 SICHERHEITSKENNZEICHNUNG GEMÄSS ASR A1.3 / DIN EN ISO 7010

Thanks to standard pictograms, the **FATH** stickers are suitable for safety marking according to ASR A1.3 / DIN EN ISO 7010. They have a particularly good warning and signal effect. And are also used as protection and hygiene stickers for all areas.



Dank normgerechten Piktogrammen eignen sich die **FATH** Aufkleber zur Sicherheitskennzeichnung gemäß ASR A1.3 / DIN EN ISO 7010. Sie haben eine besonders gute Warn- und Signalwirkung. Und werden auch als Schutz- und Hygieneaufkleber in allen Bereiche eingesetzt.

FATH STICKERS: PICTOGRAMS FOR ALL IMPORTANT MARKINGS
FATH AUFKLEBER: PIKTOGRAMME FÜR ALLE WICHTIGEN KENNZEICHNUNGEN

Prohibitive Stickers
Verbotsaufkleber



Mandatory Stickers
Gebotsaufkleber



Warning and Notice Stickers
Warn- und Hinweisaufkleber

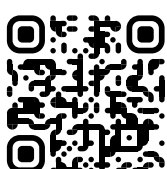

You would like to know more about the FATH Stickers?

stickers.fath24.com

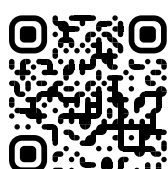

Sie möchten die FATH Aufkleber besser kennen lernen?

aufkleber.fath24.de

WARNING SLIPPERY SURFACE FLOOR SIGN

WARNUNG VOR RUTSCHGEFAHR BODENSCHILD

<p>Model Warning and Notice Sign</p> <p>Description For fast and reliable safety marking according to ASR A1.3 / DIN EN ISO 7010, self-adhesive; Easy recognition from long distance; Forklift-resistant and slip-proof floor sign with outstanding adhesive strength, suitable for almost all industrial floors, removable without leaving residue</p> <p>Material Plastic PVC</p> <p>Color Yellow / black</p> <p>Fastening Self-adhesive surface on the backside</p> <p>Pack Quantity 1 piece</p>	<p>Ausführung Warn- und Hinweisschild</p> <p>Beschreibung für die schnelle und zuverlässige Sicherheitskennzeichnung gemäß ASR A1.3 / DIN EN ISO 7010, selbstklebend; sehr gute Erkennbarkeit aus großer Entfernung; staplerfestes und trittsicheres Bodenschild mit hoher Haltekraft, für nahezu alle Industrieböden geeignet, rückstandsfrei ablösbar</p> <p>Material Kunststoff PVC</p> <p>Farbe gelb / schwarz</p> <p>Befestigung mit rückseitiger Selbstklebefläche</p> <p>Liefereinheit 1 Stück</p>
---	---



Warning Slippery Surface Floor Sign
 Warnung vor Rutschgefahr Bodenschild

Weight [g]
 Gewicht [g]

Part #
 Teil-Nr.

104.0

0203SW03



NO HANDSHAKE STICKER

HÄNDESCHÜTTELN VERBOTEN AUFKLEBER

<p>Model Prohibitive Sticker</p> <p>Description For fast and reliable safety marking according to ASR A1.3 / DIN EN ISO 7010, self-adhesive; Easy recognition from long distance; with outstanding adhesive strength, suitable for all smooth surfaces, removable without leaving residue, reusable</p> <p>Material Plastic PVC</p> <p>Color Red / white</p> <p>Fastening Self-adhesive surface on the backside</p> <p>Pack Quantity 5 pieces</p>	<p>Ausführung <i>Verbotsaufkleber</i></p> <p>Beschreibung <i>für die schnelle und zuverlässige Sicherheitskennzeichnung gemäß ASR A1.3 / DIN EN ISO 7010, selbstklebend; sehr gute Erkennbarkeit aus großer Entfernung; mit hoher Haltekraft, für alle glatten Untergründe geeignet, rückstandsfrei ablösbar, wiederverwendbar</i></p> <p>Material <i>Kunststoff PVC</i></p> <p>Farbe <i>rot / weiß</i></p> <p>Befestigung <i>mit rückseitiger Selbstklebefläche</i></p> <p>Liefereinheit <i>5 Stück</i></p>
---	--

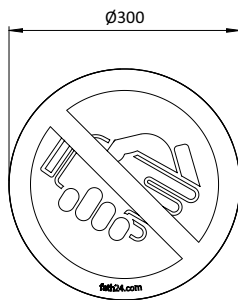

No Handshake Sticker
Händeschütteln verboten Aufkleber

Part #
Teil-Nr.

0209SP01



NO ENTRY STICKER

VERBOT DER EINFAHRT AUFKLEBER

<p>Model Prohibitive Sticker</p> <p>Description For fast and reliable safety marking according to ASR A1.3 / DIN EN ISO 7010, self-adhesive; Easy recognition from long distance; with outstanding adhesive strength, suitable for all smooth surfaces, removable without leaving residue, reusable</p> <p>Material Plastic PVC</p> <p>Color Red / white</p> <p>Fastening Self-adhesive surface on the backside</p> <p>Pack Quantity 5 pieces</p>	<p>Ausführung <i>Verbotsaufkleber</i></p> <p>Beschreibung <i>für die schnelle und zuverlässige Sicherheitskennzeichnung gemäß ASR A1.3 / DIN EN ISO 7010, selbstklebend; sehr gute Erkennbarkeit aus großer Entfernung; mit hoher Haltekraft, für alle glatten Untergründe geeignet, rückstandsfrei ablösbar, wiederverwendbar</i></p> <p>Material <i>Kunststoff PVC</i></p> <p>Farbe <i>rot / weiß</i></p> <p>Befestigung <i>mit rückseitiger Selbstklebefläche</i></p> <p>Liefereinheit <i>5 Stück</i></p>
---	--

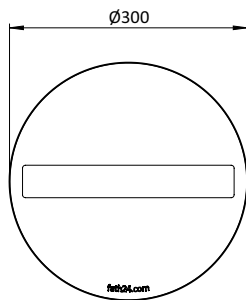

No Entry Sticker
Verbot der Einfahrt Aufkleber

Part #
Teil-Nr.

0209SP02





FACE MASK STICKER

MASKE BENUTZEN AUFKLEBER

Model Mandatory Sticker

Description For fast and reliable safety marking according to ASR A1.3 / DIN EN ISO 7010, self-adhesive; Easy recognition from long distance; with outstanding adhesive strength, suitable for all smooth surfaces, removable without leaving residue, reusable

Material Plastic PVC

Color Blue / white

Fastening Self-adhesive surface on the backside

Pack Quantity 5 pieces

Ausführung Gebotsaufkleber

Beschreibung für die schnelle und zuverlässige Sicherheitskennzeichnung gemäß ASR A1.3 / DIN EN ISO 7010, selbstklebend; sehr gute Erkennbarkeit aus großer Entfernung; mit hoher Haltekraft, für alle glatten Untergründe geeignet, rückstandsfrei ablösbar, wiederverwendbar

Material Kunststoff PVC

Farbe blau / weiß

Befestigung mit rückseitiger Selbstklebefläche

Liefereinheit 5 Stück

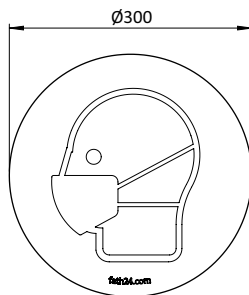

Face Mask Sticker
Maske benutzen Aufkleber

Part #
Teil-Nr.

0209SM01

FACE PROTECTION STICKER

GESICHTSCHUTZ BENUTZEN AUFKLEBER

<p>Model Mandatory Sticker</p> <p>Description For fast and reliable safety marking according to ASR A1.3 / DIN EN ISO 7010, self-adhesive; Easy recognition from long distance; with outstanding adhesive strength, suitable for all smooth surfaces, removable without leaving residue, reusable</p> <p>Material Plastic PVC</p> <p>Color Blue / white</p> <p>Fastening Self-adhesive surface on the backside</p> <p>Pack Quantity 5 pieces</p>	<p>Ausführung Gebotsaufkleber</p> <p>Beschreibung für die schnelle und zuverlässige Sicherheitskennzeichnung gemäß ASR A1.3 / DIN EN ISO 7010, selbstklebend; sehr gute Erkennbarkeit aus großer Entfernung; mit hoher Haltekraft, für alle glatten Untergründe geeignet, rückstandsfrei ablösbar, wiederverwendbar</p> <p>Material Kunststoff PVC</p> <p>Farbe blau / weiß</p> <p>Befestigung mit rückseitiger Selbstklebefläche</p> <p>Liefereinheit 5 Stück</p>
--	--

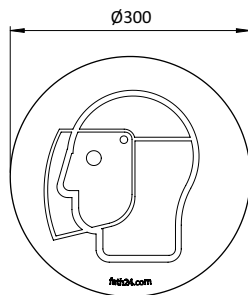

Face Protection Sticker
Gesichtschutz benutzen Aufkleber

Part #
Teil-Nr.

0209SM02

- 1
- 2
- 3
- 4
- 5
- 6
- 7
- 8



DISINFECT HANDS STICKER

HÄNDE DESINFIZIEREN AUFKLEBER

Model Mandatory Sticker

Description For fast and reliable safety marking according to ASR A1.3 / DIN EN ISO 7010, self-adhesive; Easy recognition from long distance; with outstanding adhesive strength, suitable for all smooth surfaces, removable without leaving residue, reusable

Material Plastic PVC

Color Blue / white

Fastening Self-adhesive surface on the backside

Pack Quantity 5 pieces

Ausführung Gebotsaufkleber

Beschreibung für die schnelle und zuverlässige Sicherheitskennzeichnung gemäß ASR A1.3 / DIN EN ISO 7010, selbstklebend; sehr gute Erkennbarkeit aus großer Entfernung; mit hoher Haltekraft, für alle glatten Untergründe geeignet, rückstandsfrei ablösbar, wiederverwendbar

Material Kunststoff PVC

Farbe blau / weiß

Befestigung mit rückseitiger Selbstklebefläche

Liefereinheit 5 Stück

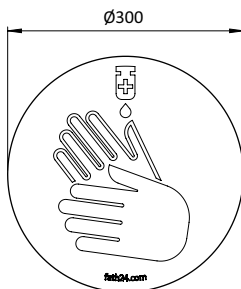

Disinfect Hands Sticker
Hände desinfizieren Aufkleber

Part #
Teil-Nr.

0209SM03

WASH HANDS STICKER

HÄNDE WASCHEN AUFKLEBER

Model	Mandatory Sticker	Ausführung	Gebotsaufkleber
Description	For fast and reliable safety marking according to ASR A1.3 / DIN EN ISO 7010, self-adhesive; Easy recognition from long distance; with outstanding adhesive strength, suitable for all smooth surfaces, removable without leaving residue, reusable	Beschreibung	für die schnelle und zuverlässige Sicherheitskennzeichnung gemäß ASR A1.3 / DIN EN ISO 7010, selbstklebend; sehr gute Erkennbarkeit aus großer Entfernung; mit hoher Haltekraft, für alle glatten Untergründe geeignet, rückstandsfrei ablösbar, wiederverwendbar
Material	Plastic PVC	Material	Kunststoff PVC
Color	Blue / white	Farbe	blau / weiß
Fastening	Self-adhesive surface on the backside	Befestigung	mit rückseitiger Selbstklebefläche
Pack Quantity	5 pieces	Liefereinheit	5 Stück

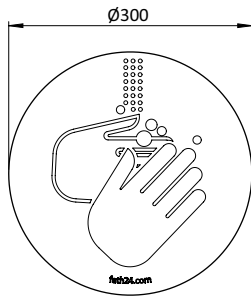

Wash Hands Sticker
 Hände waschen Aufkleber

Part #
 Teil-Nr.

0209SM04

- 1
- 2
- 3
- 4
- 5
- 6
- 7
- 8

TRAFFIC ARROW STICKER

RICHTUNGSHINWEIS AUFKLEBER

Model Mandatory Sticker

Description For fast and reliable safety marking according to ASR A1.3 / DIN EN ISO 7010, self-adhesive; Easy recognition from long distance; with outstanding adhesive strength, suitable for all smooth surfaces, removable without leaving residue, reusable

Material Plastic PVC

Color Blue / white

Fastening Self-adhesive surface on the backside

Pack Quantity 5 pieces

Ausführung Gebotsaufkleber

Beschreibung für die schnelle und zuverlässige Sicherheitskennzeichnung gemäß ASR A1.3 / DIN EN ISO 7010, selbstklebend; sehr gute Erkennbarkeit aus großer Entfernung; mit hoher Haltekraft, für alle glatten Untergründe geeignet, rückstandsfrei ablösbar, wiederverwendbar

Material Kunststoff PVC

Farbe blau / weiß

Befestigung mit rückseitiger Selbstklebefläche

Liefereinheit 5 Stück

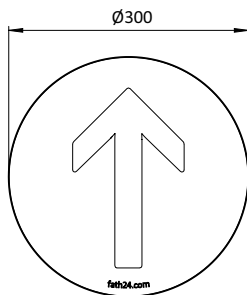

Traffic Arrow Sticker
Richtungshinweis Aufkleber

Part #
Teil-Nr.

0209SM05

SAFE DISTANCE STICKER

SICHERHEITSSABSTAND AUFKLEBER

<p>Model Warning and Notice Sticker</p> <p>Description For fast and reliable safety marking according to ASR A1.3 / DIN EN ISO 7010, self-adhesive; Easy recognition from long distance; with outstanding adhesive strength, suitable for all smooth surfaces, removable without leaving residue, reusable</p> <p>Material Plastic PVC</p> <p>Color Yellow / black</p> <p>Fastening Self-adhesive surface on the backside</p> <p>Pack Quantity 5 pieces</p>	<p>Ausführung Warn- und Hinweisaufkleber</p> <p>Beschreibung für die schnelle und zuverlässige Sicherheitskennzeichnung gemäß ASR A1.3 / DIN EN ISO 7010, selbstklebend; sehr gute Erkennbarkeit aus großer Entfernung; mit hoher Haltekraft, für alle glatten Untergründe geeignet, rückstandsfrei ablösbar, wiederverwendbar</p> <p>Material Kunststoff PVC</p> <p>Farbe gelb / schwarz</p> <p>Befestigung mit rückseitiger Selbstklebefläche</p> <p>Liefereinheit 5 Stück</p>
---	--

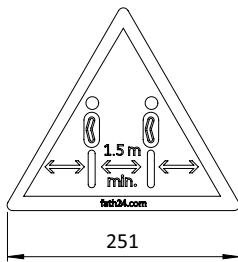

Safe Distance Sticker
Sicherheitsabstand Aufkleber

Part #
Teil-Nr.

0209SW01

- 1
- 2
- 3
- 4
- 5
- 6
- 7
- 8

INSERTING SYSTEMS *EINSTECKSYSTEME*



Container Labelings
Behälterkennzeichnungen 1

Shelf Labelings
Regalkennzeichnungen 2

Floor Markings
Bodenmarkierungen 3

Stickers
Aufkleber 4

**Inserting Systems
Einstecksysteme 5**

Visual Boards
Visual Boards 6

MATERIAL FLOW *MATERIALFLUSS*

Material Transport
Materialtransport 7

Material Supply
Materialbereitstellung 8

simply
practical

FATH[®]
COMPONENTS



INSERTING SYSTEMS EINSTECKSYSTEME

MODULAR SYSTEM
BREAK-PROOF MAILBOXES
MODULARES SYSTEM
BRUCHFESTE BRIEFKÄSTEN

STRUCTURE PRODUCTION PROCESSES, THE FLOW OF GOODS AND INFORMATION EFFICIENTLY WITH FATH INSERTING SYSTEMS PRODUKTIONSPROZESSE, WAREN- UND INFORMATIONENFLUSS EFFIZIENT STRUKTURIEREN MIT DEN FATH EINSTECKSYSTEMEN

Inserting Systems for the clear provision of information

- Inserting boxes for document sizes DIN A4, DIN A5 and 1/3 DIN
- Wall mount, e.g. for Kanban boards
- Impact-proof document holder for single use, e.g. as a mailbox

Einstecksysteme für die übersichtliche Bereitstellung von Informationen

- *Einsteckfächer für Belegmaße DIN A4, DIN A5 und 1/3 DIN*
- *Wandbefestigung z.B. für Kanban-Boards*
- *Bruchfeste Dokumentenhalter zur Einzelnutzung z.B. als Briefkasten*

FATH INSERTING SYSTEMS: EFFICIENT FLOW OF GOODS AND INFORMATION FATH EINSTECKSYSTEME: EFFIZIENTER WAREN- UND INFORMATIONENFLUSS

The **FATH** inserting systems for document sizes DIN A4, DIN A5 and 1/3 DIN are a simple tool for implementing the Kanban principle in accordance with lean production. This enables an efficient organizational structure to be created that guarantees an overview in daily production operations. The compartments ensure a seamless process in the provision of information and materials. The sequence in which the order is processed can be controlled using the inserted cards.

Single inserting box, Kanban box or Kanban board: In day-to-day operation, the inserting boxes offer quick access to the relevant information and allow processes to be put in the right order.

*Die **FATH** Einstecksysteme für die Belegmaße DIN A4, DIN A5 und 1/3 DIN sind ein einfaches Tool, um im Sinne von Lean Production das Kanban-Prinzip umzusetzen. Damit lässt sich eine effiziente Organisationsstruktur schaffen, die im täglichen Fertigungsbetrieb die Übersicht gewährleistet. Die Einsteckfächer sorgen für einen lückenlosen Prozess bei der Informations- und Materialbereitstellung. Über die eingesteckten Karten kann bei der Auftragsbearbeitung die gewünschte Reihenfolge gesteuert werden.*

Einzelfach, Kanban-Box oder Kanban-Board: Im täglichen Betrieb bieten die Einsteckfächer einen schnellen Zugriff auf die relevanten Informationen und bringen die richtige Reihenfolge in die Vorgänge.

INSERTING BOXES FOR WALLS AND KANBAN BOARDS *EINSTECKFÄCHER FÜR WÄNDE UND KANBAN-BOARDS*

Boxes for A4 documents hold construction drawings, shipping documents, etc. If the A4 documents are folded, A5 insert boxes can be used and the required space is significantly smaller. When inserted one below the other, the individual inserting boxes create a column that can be used as a Kanban board.

The inserting boxes show which process is to be processed next or what should be produced in the next step. A system as simple as it is efficient.

- MODULAR STRUCTURE
- SUITABLE FOR INDUSTRIAL USE
- DESIGNED FOR EASY HORIZONTAL CONNECTION



Kanban board: FATH Inserting System for Kanban cards

The 1/3 DIN boxes are specially designed for Kanban cards in accordance with the VDA standard. When the material is used up, the Kanban card is removed from the Kanban container and inserted into the corresponding box on the Kanban board. This signals the need for replenishment and the production can be continued without the throughput times being affected. That is lean!

Practical wall mounting for clear structure and quick overview

Sturdy metal wall brackets for screwing onto profiles, walls or machines are available as accessories for all FATH inserting boxes. This means you can implement your individual insert system and adapt it to changing requirements at any time – quickly and easily.

Boxen für DIN A4 Belege fassen Konstruktionszeichnungen, Versandpapiere usw. Werden die DIN A4 Belege gefaltet, können A5 Einsteck-Boxen genutzt werden und der Platzbedarf fällt deutlich kleiner aus. Untereinander gesteckt ergeben die einzelnen Einsteckfächer eine Kolonne, die als Kanban-Board genutzt werden kann.

Die Einsteckfächer zeigen an, welcher Vorgang als nächstes bearbeitet bzw. was im nächsten Schritt produziert werden soll. Ein ebenso einfaches wie effizientes System.

- MODULARER AUFBAU
- INDUSTRIETAUGLICHE AUSFÜHRUNG
- ZUR KOLONNENBILDUNG GEEIGNET



Kanban-Board: FATH Einstecksystem für Kanban-Karten

Die 1/3 DIN Boxen sind insbesondere für Kanban-Karten nach VDA Norm konzipiert. Ist das Material verbraucht, wird die Kanban-Karte vom Kanban-Behälter entnommen und in die entsprechende Box am Kanban-Board gesteckt. Das ist das Signal zur Nachversorgung und die Produktion kann ohne Einfluss auf die Durchlaufzeiten aufrecht erhalten werden. Das ist lean!

Praktische Wandmontage für klare Struktur und schnelle Übersicht

Stabile Wandhalter aus Metall zum Anschrauben an Profile, Wände oder Maschinen sind für alle FATH Einsteckfächer als Zubehör erhältlich. Damit können Sie Ihr individuelles Einstecksystem umsetzen und jederzeit auf geänderte Anforderungen anpassen – schnell und unkompliziert.

FATH WALL FILE POCKETS: COMPREHENSIVE INFORMATION UNDER CONTROL FATH DOKUMENTENHALTER: UMFASSENDE INFORMATIONEN IM GRIFF

The **FATH** screw-on Wall File Pockets made of break-proof plastic serve as a single compartment for document stacks or documents of all kinds, such as orders with multi-page drawings, test reports or as a collection box for Kanban cards. There is also space for thicker document stacks and process folders. In the logistics and production process, they provide a quick overview and full transparency, in two ways: The **FATH** mailboxes are transparent.

The **FATH** Wall File Pockets have two parts. The mounting plate made of solid plastic is screwed to the wall, the machine or the profile. The transparent front part can be snapped into place on this sturdy bracket. The front of the slip-in box is cut out for quick access to smaller documents. The document holders are made of extremely break-proof special plastic and can be used in any production environment.

- **IMPACT-PROOF PLASTIC**
- **LARGE CAPACITY**

*Die **FATH** Dokumentenhalter aus bruchfestem Kunststoff zum Anschrauben dienen als Einzelfach für Belegstapel oder Unterlagen aller Art, wie Aufträge mit mehrseitigen Zeichnungen, Prüfprotokolle oder als Sammelbox für Kanban-Karten. Auch dickere Belegstapel und Vorgangsmappen finden darin Platz. Im Logistik- und Produktionsprozess sorgen sie für einen schnellen Überblick und volle Transparenz, in zweifacher Hinsicht: Die **FATH** Briefkästen sind durchsichtig.*

*Die **FATH** Dokumentenhalter sind zweiteilig. Die Montageplatte aus festem Kunststoff wird an der Wand, der Maschine oder dem Profil verschraubt. An dieser stabilen Halterung wird das transparente Vorderteil mit einem Handgriff eingerastet. Für den schnellen Zugriff auch auf kleinere Dokumente ist die Vorderseite der Einsteckbox ausgespart. Die Dokumentenhalter sind aus extrem bruchsicherem Spezialkunststoff gefertigt und können in jeder Produktionsumgebung eingesetzt werden.*

- **BRUCHFESTER KUNSTSTOFF**
- **GROSSES FASSUNGSVERMÖGEN**



VERSIONS AUSFÜHRUNGEN

The FATH Inserting Systems are available in the following versions: *Die FATH Einstecksysteme sind in folgenden Ausführungen erhältlich:*

Systems Systeme	Document sizes Beleggröße
Inserting Boxes for column formation <i>Einsteckfächer zur Kolonnenbildung</i>	DIN A4 portrait DIN A5 landscape 1/3 DIN A4 portrait / VDA standard <i>DIN A4 hoch</i> <i>DIN A5 quer</i> <i>1/3 DIN A4 hoch / VDA Norm</i>
Wall File Pocket as a single compartment <i>Dokumentenhalter als Einzelfach</i>	<i>DIN A4 portrait</i> <i>DIN A4 landscape</i> <i>DIN A5 portrait</i> <i>DIN A5 landscape</i> <i>DIN A4 hoch</i> <i>DIN A4 quer</i> <i>DIN A5 hoch</i> <i>DIN A5 quer</i>

VERSIONS ZUBEHÖR

Wall bracket for Inserting Boxes.
Wandhalter für Einsteckfächer.



You would like to know more about
the FATH Inserting Systems?

inserting-system.fath24.com



*Sie möchten die FATH Einsteck-
systeme besser kennen lernen?*

einstecksystem.fath24.de

VISUAL BOARDS *VISUAL BOARDS*

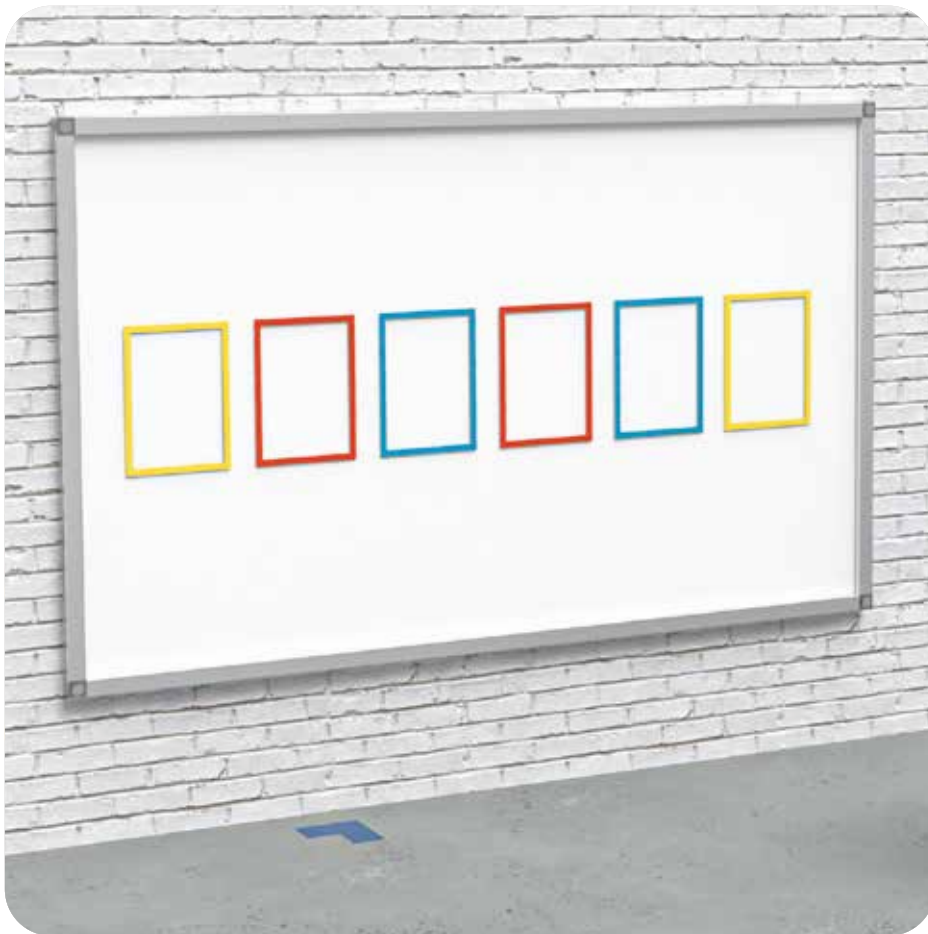

Container Labelings
Behälterkennzeichnungen 1

Shelf Labelings
Regalkennzeichnungen 2

Floor Markings
Bodenmarkierungen 3

Stickers
Aufkleber 4

Inserting Systems
Einstecksysteme 5

**Visual Boards
Visual Boards 6**

MATERIAL FLOW *MATERIALFLUSS*

Material Transport
Materialtransport 7

Material Supply
Materialbereitstellung 8



Magnetic Document Window DIN A4 - 8.3" x 11.7"
Magnetisches Dokumentenfenster DIN A4

137



Magnetic Document Window DIN A3 - 11.7" x 16.5"
Magnetisches Dokumentenfenster DIN A3

138



Monitor Support 4-axis, Height Adjustable
Monitorhalter 4 Achsen, höhenverstellbar

139



Monitor Support 5-axis, Height Adjustable
Monitorhalter 5 Achsen, höhenverstellbar

141



Monitor Work Station SIT / STAND 4-axis, Profile Attachment (Set)
Monitor Arbeitsplatz SIT / STAND 4 Achsen, Profilbefestigung (Set)

143

simply
practical

VISUAL BOARDS VISUAL BOARDS

FATH®
COMPONENTS



ENAMELED SURFACE
EMAILLIERTE OBERFLÄCHE

KEY PERFORMANCE FIGURES PRESENTED IN A CLEARLY ARRANGED, FLEXIBLE FORMAT: ALL KEY INFORMATION AT A GLANCE WITH FATH'S VISUAL BOARDS KENNZAHLEN ÜBERSICHTLICH UND FLEXIBEL: ALLE WICHTIGEN INFORMATIONEN IM BLICK MIT DEN FATH VISUAL BOARDS

FATH's Visual Boards: Quality enameled surface

The surfaces on all FATH's Visual Boards are made of enamel, making them a premium product. A glass-like mixture is applied to the metal surface at temperatures of around 1000 degrees Celsius (1832 degrees Fahrenheit) and then hardened. The result is a surface with special properties. The whiteboard surface is extremely easy to clean by simply wiping it with a dry towel. While conventional whiteboards with lacquered surfaces still leave residues from writing after wiped down, FATH's Visual Boards can be cleaned without leaving any residue.

The enameled whiteboard surfaces are scratch-resistant, extremely durable and retain their smooth feel on a permanent basis. Surfaces remain undamaged even after daily use and repeated writing and wiping. Besides writing, the entire metal surface can be used with magnets, thus turning the whiteboard into a magnetic board.

Visual Boards for every need and flexible arrangement of information

- Enameled surface
- Permanent protection against marker residue
- Different designs: Enamel wall board, mobile enamel board, mobile enamel cube
- Magnetic use across the entire surface
- Enamel panels available separately

- RESIDUE-FREE CLEANING
- SCRATCH-RESISTANT

FATH Visual Boards: Qualität durch emaillierte Oberfläche

Die Oberflächen aller FATH Visual Boards bestehen aus Emaille – die Königsklasse! Bei Temperaturen von rund 1000 Grad Celsius wird ein glasähnliches Gemisch auf die Metallfläche aufgetragen und anschließend gehärtet. Das Ergebnis ist eine Oberfläche mit besonderen Eigenschaften. Die Whiteboard-Fläche ist extrem leicht zu säubern, sie kann einfach trocken abgewischt werden. Während bei herkömmlichen Whiteboards mit lackierten Oberflächen nach dem Abwischen noch Rückstände der Beschriftung zu sehen sind, lassen sich die FATH Visual Boards rückstandsfrei reinigen.

Die emaillierten Whiteboard-Flächen sind kratzfest, extrem widerstandsfähig und behalten dauerhaft ihre glatte Haptik. Auch bei täglichem Gebrauch und vielfachem Beschriften und Auswischen bleiben die Oberflächen unbeschädigt. Zusätzlich zur Beschriftung ist die metallische Oberfläche durchgehend magnetisch nutzbar – so wird das Whiteboard zur Magnettafel.

Visual Boards für jede Anforderung und flexible Informationsbereitstellung

- Emaillierte Oberfläche
- Dauerhafter Schutz vor Marker-Rückständen
- Unterschiedliche Bauformen: Emaille Wandboard, Mobiles Emaille Board, Mobiler Emaille Cube
- Vollflächig magnetisch nutzbar
- Emaille-Platten separat erhältlich

- RÜCKSTANDSFREIE REINIGUNG
- KRATZFEST

THREE DESIGNS FOR EVERY APPLICATION *DREI BAUFORMEN FÜR JEDEN EINSATZ*

Each **FATH** Visual Board design features a metallic whiteboard surface framed in an aluminum profile measuring 40 x 40 mm. Attachments such as monitor, keyboard, or scanner mounts, shelves or header profiles can be effortlessly integrated. Enamel wall boards not only attach to walls but are also suitable for mounting on machine enclosures or safety fences. Mobile enamel boards are not only available in a single-sided version but they are also available in a double-sided version with an enamel surface on the front and back.

Bei jeder Bauform der FATH Visual Boards sind die metallischen Whiteboard-Flächen in einem Aluminiumprofil mit 40 x 40 mm Profilmaß eingefasst. Die Integration von Anbauteilen, wie Monitorhalter, Tastaturhalter, Scannerhalter, Ablagen oder Überschriftenprofile zur Abteilungskennzeichnung, ist problemlos möglich. Emaille Wandboards finden nicht nur an Wänden sicheren Halt, sondern eignen sich zur Montage an Maschinen-Einhausungen oder Regalanlagen. Mobile Emaille Boards sind in einseitiger oder zweiseitiger Ausführung mit Email-Oberfläche auf der Vorder- und Rückseite erhältlich.

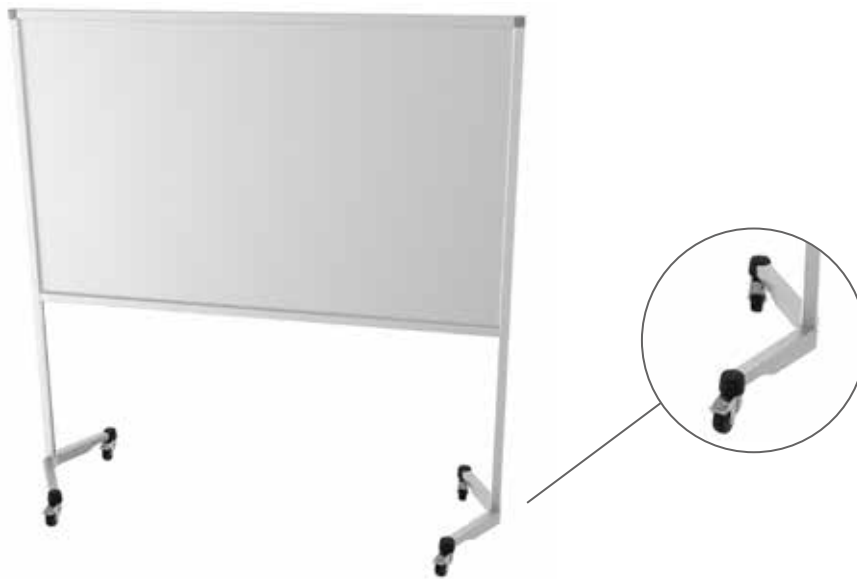

A special added extra: The feet on the visual boards are rubberized on their exterior. The rubber buffer above the floor rollers protects against injury and damage to walls and doors.

Ein besonderes Detail: Die FüÙe der Visual Boards sind an den Außenseiten gummiert. Der Gummipuffer über den Rollen schützt vor Verletzungen und Beschädigungen an Wänden und Türen.

Mobile enamel boards: Information flexibly delivered

Mobile enamel boards are placed anywhere in the room and can be easily moved around on their stand and floor rollers at any time. The integrated brakes ensure they are held securely in position. This design is ideal when machines are too small to attach wallboards. The mobile enamel boards are also an ideal choice for office areas or foreman's offices as their height will fit through any standard door. The structure is the same as that of **FATH's** wall-mounted enamel boards. Industrial floor rollers with brakes are also available as an option in the ESD version.

Mobiles Emaille Board: Flexible Informationsbereitstellung

Die mobilen Emaille Boards werden frei im Raum platziert und lassen sich durch die Standvorrichtung mit Rollen jederzeit leicht verschieben. Die integrierten Feststeller sorgen für sicheren Stand. Diese Bauform ist ideal, wenn Maschinen zu klein zum Anbringen des Boards sind. Auch für Bürobereiche oder Meisterkabinen sind die mobilen Emaille Boards eine gute Wahl, da sie in der Höhe durch jede Standardtür passen. Der Aufbau entspricht dem der FATH Emaille Wandboards. Optional sind die Industrierollen mit Feststeller auch in ESD-Ausführung erhältlich.



Wall-mounted enamel board: Easy to attach to aluminum profiles

This design is suitable for both mounting on walls and attaching on machine enclosures or safety fences. Mounting on aluminum profiles is completed in minutes using the whiteboard's 40 x 40 mm profile frame. Monitors or warning signal lamps can be attached to the profile exterior. The visible side of the profile is enclosed.

Emaille Wandboard: Einfache Befestigung am Aluprofil

Diese Ausführung eignet sich für die Wandmontage genauso wie zur Anbringung an Maschinen-Einhausungen oder Schutzzäunen. Die Montage an Aluminiumprofilen ist durch die Profil-Einfassung 40 x 40 mm des Whiteboards mit wenigen Handgriffen erledigt. Monitore oder Warn-Signalleuchten können an der Profil-Außen-seite befestigt werden. Die Sichtseite des Profils ist geschlossen.



Mobile enamel cube: Space-saver on floor rollers

Thinking outside the box: Thanks to its four enameled sides, the FATH Visual Board in the shape of a cube offers ample space over a small surface area. Just around one square meter floor space is required to provide just as much information as on a whiteboard almost three meters wide. As the mobile Enamel Cube fits through any standard door, it can be placed in any space – from meeting rooms to production and storage areas. This space-saving, square design is perfectly suited for providing important information and production notices in any location. The metallic surfaces on the mobile enamel cube are also framed in 40 x 40 mm aluminum profiles. The visible sides of the profile are enclosed to protect against contamination and deposits. Industrial floor rollers with brakes are optionally available in an ESD version.

Mobiler Emaille Cube: Platzwunder auf Rollen

Um die Ecke gedacht: Durch seine vier emaillierten Seiten bietet das FATH Visual Board in Form eines Cubes enorm viel Platz auf kleiner Grundfläche. Nur rund ein Quadratmeter Bodenfläche ist nötig, um gleich viele Informationen wie bei einem fast drei Meter breiten Whiteboard zu fassen. Da der mobile Emaille Cube durch jede Standardtür passt, kann er in allen Räumlichkeiten aufgestellt werden, vom Besprechungsraum bis zum Produktions- und Lagerbereich. Diese platzsparende, quadratische Bauform eignet sich perfekt für die ortsungebundene Bereitstellung umfangreicher Informationen und Produktionsaushänge. Auch beim mobilen Emaille Cube sind die metallischen Oberflächen in Aluprofile 40 x 40 mm eingefasst. Zum Schutz vor Verunreinigungen und Ablagerungen sind die Sichtseiten des Profils geschlossen. Industrierollen mit Feststeller sind optional auch als ESD-Ausführung verfügbar.

ACCESSORIES ZUBEHÖR

Available separately: Enameled panels for customized designs

The enameled Visual Board panels are available separately upon request for customization. This allows you to build your own whiteboard or magnetic board with custom-fit dimensions. The whiteboard panels are simply framed in your own profile. In addition to wall mounting, specific needs, such as attachment to machines, can also be met.

- Board markers** pens (German-made)
- Board cleaner** cleaning agent (German-made)
- Board wiper** for dry cleaning – quick cleaning of large surfaces
- Keyboard holder** shelf made of aluminum
- Header profiles** for identification purposes such as departments or specific areas
- Shadow Board** Magnetic holder for all accessories

Separat erhältlich: Emailierte Platten für individuelle Anfertigungen

Die emailierten Visual Board-Platten sind auf Kundenwunsch separat erhältlich. Damit können Sie Ihr individuelles Whiteboard bzw. Ihre Magnettafel mit passgenauen Maßen konstruieren. Die Whiteboard-Platten werden einfach in Ihr eigenes Profil eingefasst. Neben der Wandbefestigung lassen sich so auch spezifische Anforderungen, wie die Anbringung an Maschinen, erfüllen.

- Board Marker** Stifte (Made in Germany)*
- Board Reiniger** Reinigungsmittel (Made in Germany)*
- Board Wischer** für die Trockenreinigung – schnelles Reinigen großer Flächen*
- Tastatur-Halter** Ablage aus Aluminium*
- Überschriftenprofil** zur Kennzeichnung (z.B. Bereich / Abteilung)*
- Shadow Board** Magnetischer Halter für alle Zubehör-Artikel*

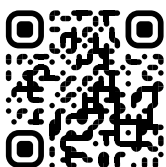

You would like to know more about the FATH Visual Boards?

visual-board.fath24.com

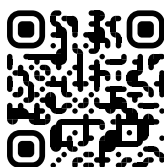

Sie möchten die FATH Visual Boards besser kennen lernen?

visual-board.fath24.de

simply
practical

FATH®
COMPONENTS



MAGNETIC DOCUMENT WINDOWS MAGNETISCHE DOKUMENTENFENSTER

STRONG HOLD, HIGHLY VISIBLE
STARKER HALT, GUTE SICHTBARKEIT

PROVIDE INFORMATION IN A CLEARLY ARRANGED, SECURED FORMAT WITH MAGNETIC FATH'S DOCUMENT WINDOWS

INFORMATIONEN ÜBERSICHTLICH UND SICHER BEREITSTELLEN MIT DEN MAGNETISCHEN FATH DOKUMENTENFENSTERN

Magnetic document windows for visual boards and metal surfaces

Dokumentenfenster für Visual Boards und metallische Flächen

- Special printing concept
- Long-lasting frame color
- For document sizes A3 (11.7" x 16.5") and A4 (8.3" x 11.7")
- Can be used in landscape and portrait formats
- Available in many colors

- *Spezielles Druckkonzept*
- *Langlebige Rahmenfarbe*
- *Für Belegformate A3 und A4*
- *Im Hochformat und Querformat verwendbar*
- *Viele Farben erhältlich*

- **PORTRAIT AND LANDSCAPE FORMAT**
- **CLEARLY ARRANGED STRUCTURE**

- **HOCH- UND QUERFORMAT**
- **ÜBERSICHTLICHE STRUKTUR**

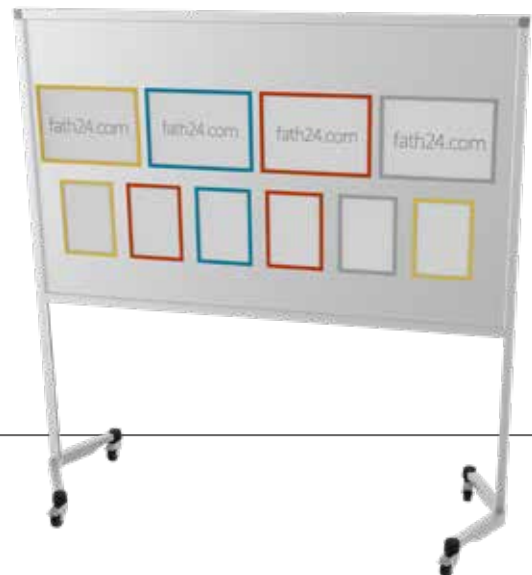

MAGNETIC DOCUMENT WINDOW: PROVIDING INSTANT AND VARIABILITY OF INFORMATION MAGNETISCHE DOKUMENTENFENSTER: SCHNELLE UND VARIABLE INFORMATIONSBEREITSTELLUNG

You can use these magnetic document windows to attach required information and data to any metal board or surface using their simple, variable, clearly arranged format. The magnetic strips with extra strong adhesion on the back of the document window are designed to be used in either portrait or landscape format. The magnetic document windows are available for document sizes A3 (11.7" x 16.5") and A4 (8.3" x 11.7"). Receipts and documents can be changed instantly, are held securely, and are protected from dirt by the transparent window. The transparent window is scanner readable and easy to clean.

Mit den magnetischen Dokumentenfenstern können Sie auf jeder metallischen Tafel oder Fläche die benötigten Informationen und Daten anbringen - einfach, variabel und übersichtlich. Die rückseitigen Magnetstreifen mit extra starker Haftkraft sind so konzipiert, dass die Fenster im Hochformat und im Querformat genutzt werden können. Erhältlich sind die magnetischen Dokumentenfenster für die Belegmaße A3 und A4. Belege und Dokumente lassen sich blitzschnell auswechseln, haben sicheren Halt und sind durch das transparente Fenster vor Verschmutzung geschützt. Die Deckfolie ist Scanner lesbar und leicht zu reinigen.

LONG-LASTING VIBRANT COLOR IS ADDED TO THE FRAME OF THE WINDOW THANKS TO A UNIQUE PRINTING TECHNIQUE

LANGLEBIGE FARBINTENSITÄT DURCH SPEZIELLES DRUCKKONZEPT

What makes magnetic document windows so special: The frame color is printed on the inside. This procedure completely encloses the ink between the film and the magnetic strip, thus permanently protecting the print on both sides from wear and scratching. Color intensity is maintained even with prolonged use.

Das Besondere an den magnetischen Dokumentenfenstern: Die Rahmenfarbe wird auf der Innenseite aufgedruckt. Durch diese Vorgehensweise wird die Farbe vollständig zwischen Folie und Magnetstreifen eingeschlossen und die Bedruckung ist somit auf beiden Seiten dauerhaft vor Abnutzung und Verkratzen geschützt. Die Farbintensität bleibt auch bei langem Einsatz erhalten.

DIFFERENT COLORS FOR CLEAR IDENTIFICATION AND ORGANIZATION

VERSCHIEDENE FARBEN FÜR KLARE KENNZEICHNUNG UND STRUKTUR

The different frame colors allow you to create a color index for specific products or define a color chart for topic blocks. For example, the 4 mm wide color frame makes it possible to clearly identify and selectively communicate target achievements, quality, order backlogs, personnel deployment matrix, personnel qualification matrix, and general employee and company information. The color coding enables all employees to see relevant notices intuitively at a glance. Visual boards and other metal information surfaces can be laid out in a neatly structured manner.

Mit den unterschiedlichen Rahmenfarben können Sie einen Farbindex für verschiedene Kennzahlen oder ein Farbregister für Themenblöcke definieren. So lassen sich beispielsweise Kennzahlen zur Zielerreichung, zur Qualität oder zum Auftragsbestand, die Personaleinsatzmatrix oder Personalqualifizierungsmatrix sowie allgemeine Mitarbeiter- und Unternehmensinfos mittels der 4 mm breiten Farbeinrahmung deutlich erkennen und trennscharf kommunizieren. Durch die farbliche Kennzeichnung sehen alle Mitarbeiter die relevanten Aushänge intuitiv auf einen Blick. Visual Boards und andere metallische Infoflächen können ordentlich strukturiert gestaltet werden.



WIDE VARIETY OF OPTIONS FOR USE AND ATTACHMENT

VIelfÄLTIGE MÖGLICHKEITEN FÜR EINSATZ UND ANBRINGUNG

- On the shop floor visual boards that hold information on shift hand-overs or quality meetings
- On enclosures and machine protection fencing to identify machines
- On circuit diagrams and safety instructions in electrical control cabinets
- In employee areas and offices for notices to personnel changes or company news.

- Auf Visual Boards im Shopfloor für Informationen zur Schichtübergabe oder Qualitätsbesprechungen
- An Einhausungen und Maschinenschutzgittern zur Maschinenkennzeichnung
- In Elektroschaltschränken für Schaltpläne und Sicherheitshinweise
- In Mitarbeiterbereichen und Büros für Aushänge zu Personalveränderungen oder Neuigkeiten z.B. vom Betriebsrat

VERSIONS

AUSFÜHRUNGEN

The magnetic document windows are available in DIN A4 (8.3" x 11.7") and DIN A3 (11.7" x 16.5") format with a wide variety of colors.

Die magnetischen Dokumentenfenster sind in Ausführung DIN A4 und DIN A3 sowie in vielen Farben erhältlich.



You would like to know more about the Magnetic Document Windows from FATH?

document-window.fath24.com

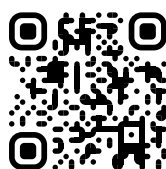

Sie möchten die magnetischen Dokumentenfenster von FATH besser kennen lernen?

dokumentenfenster.fath24.de

MAGNETIC DOCUMENT WINDOW DIN A4 - 8.3" X 11.7" MAGNETISCHES DOKUMENTENFENSTER DIN A4

<p>Model DIN A4 - 8.3" x 11.7" portrait / landscape format</p> <p>Description For variable and structured information provision through secure hold on metallic surfaces e.g. of visual boards / whiteboards;#b Color coding for different key figures or topic blocks, frame color permanently enclosed between outer foil and surrounding magnetic frame; Protects documents from dust and dirt, documents are easily exchangeable; Useable in portrait and landscape format, easy to reposition thanks to 4 magnetic sides</p> <p>Material Plastic PC</p> <p>Color Yellow, red, blue, gray</p> <p>Pack Quantity 10 pieces</p>	<p>Ausführung DIN A4 Hochformat / Querformat</p> <p>Beschreibung zur variablen und strukturierten Informationsbereitstellung durch sicheren Halt auf metallischen Oberflächen z.B. von Visual Boards / Whiteboards; farbliche Kennzeichnung für verschiedene Kennzahlen oder Themenblöcke, Rahmenfarbe dauerhaft zwischen Außenfolie und umlaufenden Magnetrand eingeschlossen; schützt Dokumente vor Verschmutzung, Belege einfach auswechselbar; im Hochformat und im Querformat einsetzbar, durch 4 magnetische Seiten leicht neu zu positionieren</p> <p>Material Kunststoff PC</p> <p>Farbe gelb, rot, blau, grau</p> <p>Liefereinheit 10 Stück</p>
---	---

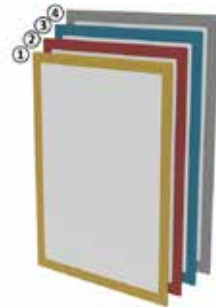
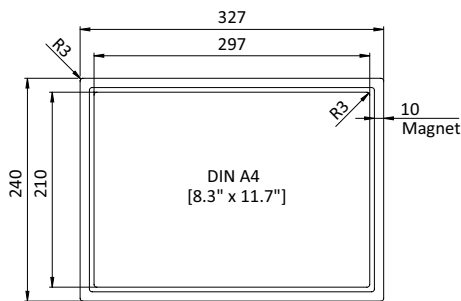

Fig. Abb.	Magnetic Document Window DIN A4 - 8.3" x 11.7" Magnetisches Dokumentenfenster DIN A4	Color Farbe	Weight [g] Gewicht [g]	Part # Teil-Nr.
①		Yellow ≈ RAL 1018 <i>gelb</i>	164.3	02065WA415
②		Red ≈ RAL 3020 <i>rot</i>	164.3	02065WA431
③		Blue ≈ RAL 5017 <i>blau</i>	164.3	02065WA455
④		Gray ≈ RAL 7045 <i>grau</i>	164.3	02065WA475



MAGNETIC DOCUMENT WINDOW
DIN A3 - 11.7" X 16.5"

MAGNETISCHES DOKUMENTENFENSTER
DIN A3

<p>Model DIN A3 - 11.7" x 16.5" portrait / landscape format</p> <p>Description For variable and structured information provision through secure hold on metallic surfaces e.g. of visual boards / whiteboards;#b Color coding for different key figures or topic blocks, frame color permanently enclosed between outer foil and surrounding magnetic frame; Protects documents from dust and dirt, documents are easily exchangeable; Useable in portrait and landscape format, easy to reposition thanks to 4 magnetic sides</p> <p>Material Plastic PC</p> <p>Color Yellow, red, blue, gray</p> <p>Pack Quantity 10 pieces</p>	<p>Ausführung DIN A3 Hochformat / Querformat</p> <p>Beschreibung zur variablen und strukturierten Informationsbereitstellung durch sicheren Halt auf metallischen Oberflächen z.B. von Visual Boards / Whiteboards; farbliche Kennzeichnung für verschiedene Kennzahlen oder Themenblöcke, Rahmenfarbe dauerhaft zwischen Außenfolie und umlaufenden Magnetrand eingeschlossen; schützt Dokumente vor Verschmutzung, Belege einfach auswechselbar; im Hochformat und im Querformat einsetzbar, durch 4 magnetische Seiten leicht neu zu positionieren</p> <p>Material Kunststoff PC</p> <p>Farbe gelb, rot, blau, grau</p> <p>Liefereinheit 10 Stück</p>
--	---

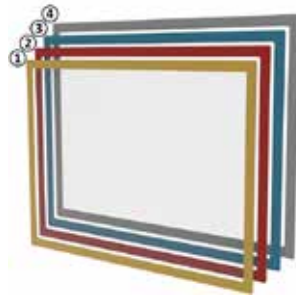
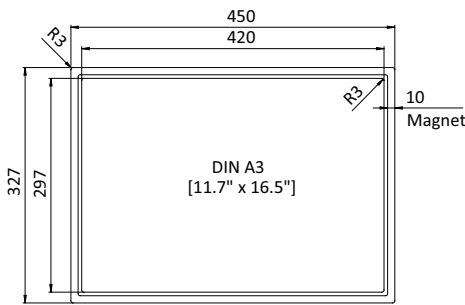
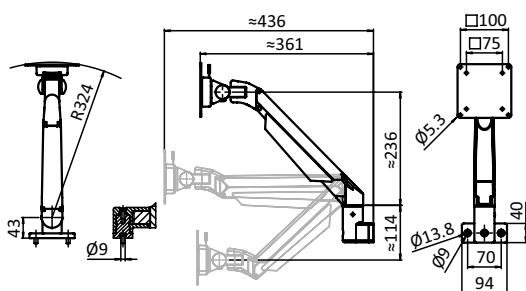

Fig. Abb.	Magnetic Document Window DIN A3 - 11.7" x 16.5" Magnetisches Dokumentenfenster DIN A3	Color Farbe	Weight [g] Gewicht [g]	Part # Teil-Nr.
①		Yellow ≈ RAL 1018 <i>gelb</i>	247.5	02065WA315
②		Red ≈ RAL 3020 <i>rot</i>	247.5	02065WA331
③		Blue ≈ RAL 5017 <i>blau</i>	247.5	02065WA355
④		Gray ≈ RAL 7045 <i>grau</i>	247.5	02065WA375

MONITOR SUPPORT 4-AXIS, HEIGHT ADJUSTABLE

MONITORHALTER 4 ACHSEN, HÖHENVERSTELLBAR

Model	4-axis	Ausführung	4 Achsen
Description	for removable mounting of monitors with 2 - 10 kg, mounting plate VESA MIS-D 75/100 compatible; adjustable viewing angle and height, screen rotatable by 90°; 360° mounting flange for horizontal and vertical attachment with mounting adapter	Beschreibung	zum abnehmbaren Befestigen von Monitoren mit 2 - 10 kg, Befestigungsplatte VESA MIS-D 75/100 kompatibel; Blickwinkel und Höhe einstellbar, Bildschirm um 90° drehbar; 360° Montage-Flansch zur horizontalen und vertikalen Montage mit Montageadapter
Material	Mounting plate VESA, removable: Steel / Plastic Monitor mount: Die-cast aluminum Cable management cover: Plastic Bearing shims and bushes: Plastic Mounting flange: Die-cast aluminum Mounting adapter: Die-cast aluminum Screws: Steel	Material	Befestigungsplatte VESA, abnehmbar: Stahl / Kunststoff Monitorhalter: Aluminiumdruckguss Abdeckung Kabelführung: Kunststoff Lagerscheiben und -hülsen: Kunststoff Montage-Flansch: Aluminiumdruckguss Montage-Adapter: Aluminiumdruckguss Schrauben: Stahl
Surface	Mounting plate VESA, removable: Lacquered Monitor mount: Lacquered Mounting flange: Lacquered Mounting adapter: Lacquered Screws: Zinc plated	Oberfläche	Befestigungsplatte VESA, abnehmbar: lackiert Monitorhalter: lackiert Montage-Flansch: lackiert Montage-Adapter: lackiert Schrauben: verzinkt
Color	Mounting plate VESA, removable: #b Alu color / black Monitor mount: Alu color Cable management cover: Black Bearing shims and bushes: Black Mounting flange: Alu color Mounting adapter: alu color	Farbe	Befestigungsplatte VESA, abnehmbar: alufarbig / schwarz Monitorhalter: alufarbig Abdeckung Kabelführung: schwarz Lagerscheiben und -hülsen: schwarz Montage-Flansch: alufarbig Montage-Adapter: alufarbig
Set	1 mounting plate VESA with 4 screws – M4 × 12, Phillips 1 monitor support 4-axis with cable management cover 1 mounting flange 1 mounting screw DIN 6912 – M8 × 25 1 mounting adapter 2 mounting screws DIN 6912 – M8 × 16 1 hexagon key, AF 3 1 hexagon key, AF 4	Set	1 Befestigungsplatte VESA inklusiv 4 Schrauben – M4 x 12, Kreuzschlitz 1 Monitorhalter 4 Achsen inklusive Abdeckung Kabelführung 1 Montage-Flansch 1 Montageschraube DIN 6912 – M8 x 25 1 Montage-Adapter 2 Montageschrauben DIN 6912 – M8 x 16 1 Sechskantschlüssel, SW 3 1 Sechskantschlüssel, SW 4
Pack Quantity	1 piece	Liefereinheit	1 Stück



MONITOR SUPPORT 4-AXIS, HEIGHT ADJUSTABLE

MONITORHALTER 4 AXSEN, HÖHENVERSTELLBAR

Monitor Support 4-axis, Height Adjustable
 Monitorhalter 4 Achsen, höhenverstellbar

Max. Load [kg]
 Tragkraft [kg]

Weight [g]
 Gewicht [g]

Part #
 Teil-Nr.

10.0

2200.0

6MHM75100S40

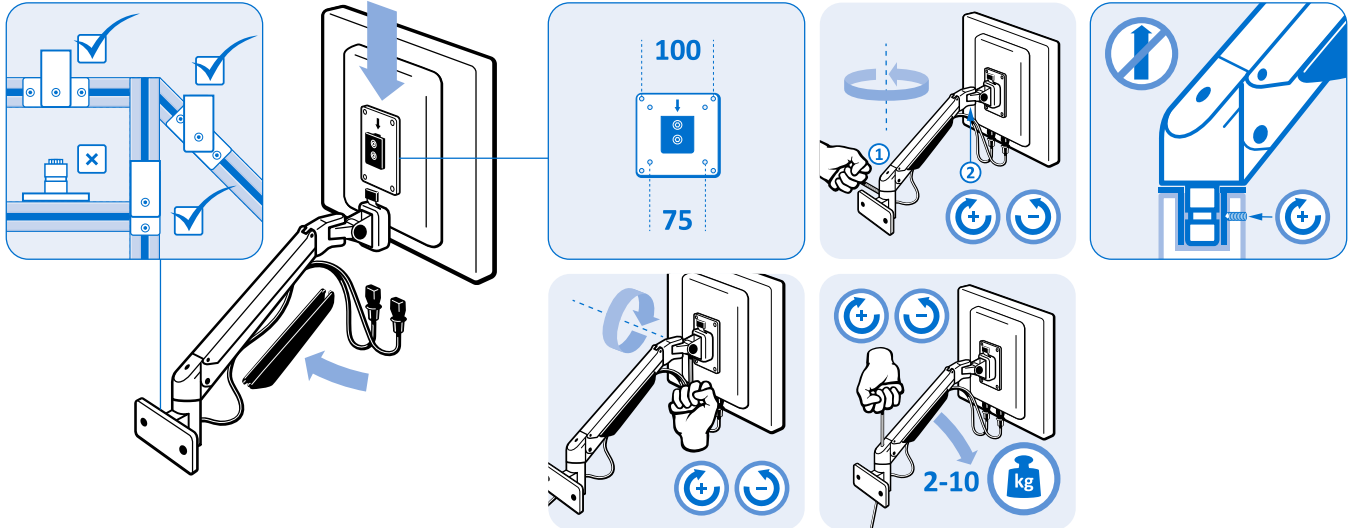

MONITOR SUPPORT 5-AXIS, HEIGHT ADJUSTABLE

MONITORHALTER 5 ACHSEN, HÖHENVERSTELLBAR

Model	5-axis	Ausführung	5 Achsen
Description	for removable mounting of monitors with 2 - 10 kg, mounting plate VESA MIS-D 75/100 compatible; adjustable viewing angle and height, screen rotatable by 90°; 360° mounting flange for horizontal and vertical attachment with mounting adapter	Beschreibung	zum abnehmbaren Befestigen von Monitoren mit 2 - 10 kg, Befestigungsplatte VESA MIS-D 75/100 kompatibel; Blickwinkel, Höhe und Abstand einstellbar, Bildschirm um 90° drehbar; 360° Montage-Flansch zur horizontalen und vertikalen Montage mit Montageadapter, als auch zur Montage auf Flächen mit dem Montage-Adapter ohne den Montage-Flansch
Material	Mounting plate VESA, removable: Steel / Plastic Monitor mount: Die-cast aluminum Cable management cover: Plastic Bearing shims and bushes: Plastic Mounting flange: Die-cast aluminum Mounting adapter: Die-cast aluminum Screws: Steel	Material	Befestigungsplatte VESA, abnehmbar: Stahl / Kunststoff Monitorhalter: Aluminiumdruckguss Abdeckung Kabelführung: Kunststoff Lagerscheiben und -hülsen: Kunststoff Montage-Flansch: Aluminiumdruckguss Montage-Adapter: Aluminiumdruckguss Schrauben: Stahl
Surface	Mounting plate VESA, removable: Lacquered Monitor mount: Lacquered Mounting flange: Lacquered Mounting adapter: Lacquered Screws: Zinc plated	Oberfläche	Befestigungsplatte VESA, abnehmbar: lackiert Monitorhalter: lackiert Montage-Flansch: lackiert Montage-Adapter: lackiert Schrauben: verzinkt
Color	Mounting plate VESA, removable: #b Alu color / black Monitor mount: Alu color Cable management cover: Black Bearing shims and bushes: Black Mounting flange: Alu color Mounting adapter: alu color	Farbe	Befestigungsplatte VESA, abnehmbar: alufarbig / schwarz Monitorhalter: alufarbig Abdeckung Kabelführung: schwarz Lagerscheiben und -hülsen: schwarz Montage-Flansch: alufarbig Montage-Adapter: alufarbig
Set	1 mounting plate VESA with 4 screws – M4 × 12, Phillips 1 monitor support 5-axis with cable management cover 1 mounting flange 1 mounting screw DIN 6912 – M8 × 25 1 mounting adapter 2 mounting screws DIN 6912 – M8 × 16 1 hexagon key, AF 3 1 hexagon key, AF 4	Set	1 Befestigungsplatte VESA inklusiv 4 Schrauben – M4 x 12, Kreuzschlitz 1 Monitorhalter 5 Achsen inklusive Abdeckung Kabelführung 1 Montage-Flansch 1 Montageschraube DIN 6912 – M8 x 25 1 Montage-Adapter 2 Montageschrauben DIN 6912 – M8 x 16 1 Sechskantschlüssel, SW 3 1 Sechskantschlüssel, SW 4
Pack Quantity	1 piece	Liefereinheit	1 Stück

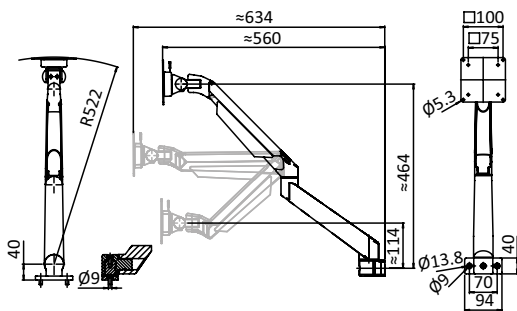

MONITOR SUPPORT 5-AXIS, HEIGHT ADJUSTABLE

MONITORHALTER 5 AXSEN, HÖHENVERSTELLBAR

Monitor Support 5-axis, Height Adjustable
 Monitorhalter 5 Achsen, höhenverstellbar

Max. Load [kg]
 Tragkraft [kg]

Weight [g]
 Gewicht [g]

Part #
 Teil-Nr.

	10.0	2930.0	6MHM75100D40
--	------	--------	--------------

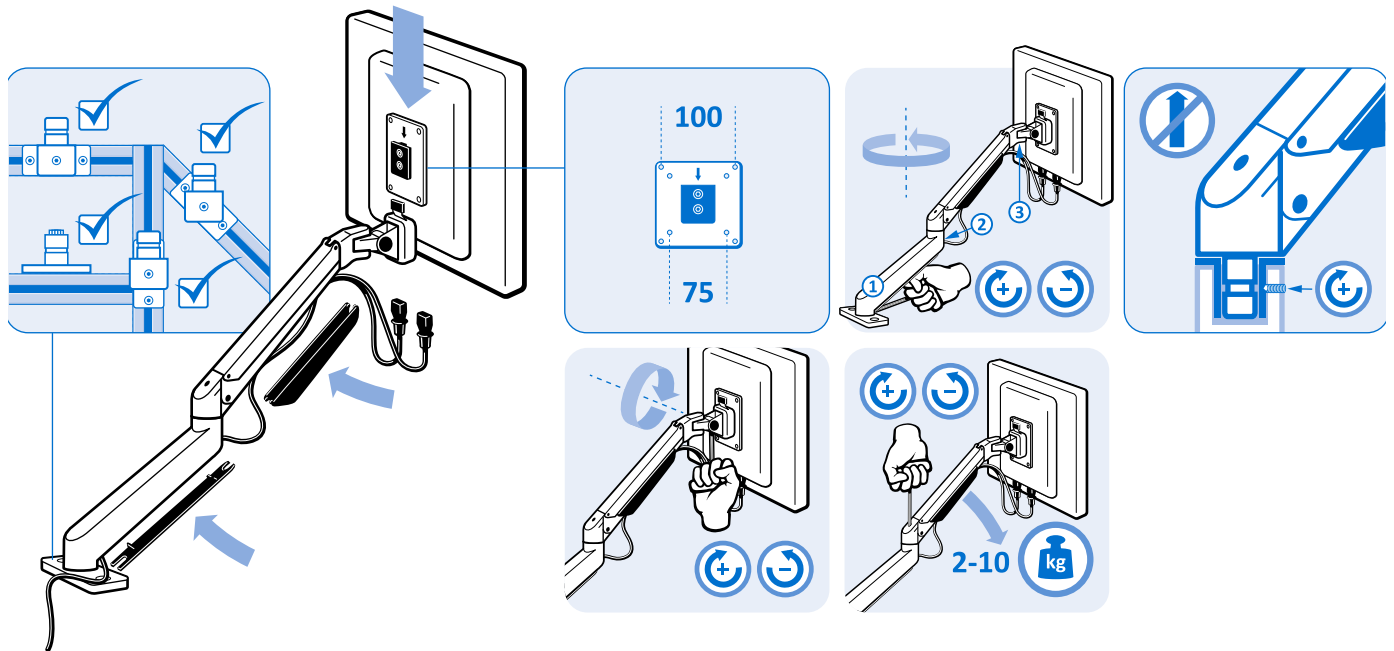

MONITOR WORK STATION SIT / STAND 4-AXIS, PROFILE ATTACHMENT (SET)

MONITOR ARBEITSPLATZ SIT / STAND 4 ACHSEN, PROFILBEFESTIGUNG (SET)

Model	4-axis	Ausführung	4 Achsen
Description	For mounting of monitors with 2 - 8 kg, mounting plate VESA MIS-D 75/100 compatible, adjustable viewing angle and height; fold-up holder with wrist rest for keyboard up to 2.5 kg, incl. left or right pull-out shelf for mouse, as well as holders for hand scanner and mouse; 360° mounting flange can be attached lateral, transverse, or on the face of the profile, if attached on the front face, the core hole of the respective profile must be M8 threaded	Beschreibung	zum Befestigen von Monitoren mit 2 - 8 kg, Befestigungsplatte VESA MIS-D 75/100 kompatibel, Blickwinkel und Höhe einstellbar; hochklappbare Ablage mit gelenkschonender Handballenauflage für Tastatur bis 2,5 kg, inkl. links oder rechts ausziehbarer Ablage für Maus, sowie Halterungen für Scanner und Maus; 360° Montage-Flansch kann längs, quer oder stirnseitig am Profil angebracht werden, bei der stirnseitigen Anwendung muss an der Kernbohrung ein Gewinde M8 vorhanden sein
Material	Monitor Work Station: Steel / aluminum / plastic Cable management cover: Plastic Mounting flange: Aluminum die-cast Screws: Steel	Material	Monitor Arbeitsplatz: Stahl / Aluminium / Kunststoff Abdeckung Kabelführung: Kunststoff Montage-Flansch: Aluminiumdruckguss Schrauben: Stahl
Surface	Monitor Work Station: Lacquered Mounting flange: Lacquered Screws: Zinc plated	Oberfläche	Monitor Arbeitsplatz: lackiert Montage-Flansch: lackiert Schrauben: verzinkt
Color	Monitor Work Station: Gray Cable management cover: Gray Mounting flange: Alu color	Farbe	Monitor Arbeitsplatz: grau Abdeckung Kabelführung: grau Montage-Flansch: alufarbig
Set	1 monitor work station incl. keyboard holder and cable management cover 1 mounting flange incl. bolt and cover cap 1 screw DIN 912 - M8 x 45 (for T-slot nut) 1 screw DIN 912 - M8 x 50 (for core hole) 1 washer 8-FSt 1 centering plate - slot 8 1 centering plate - slot 10 1 T-slot nut - slot 8 - M8 1 T-slot nut - slot 10 - M8	Set	1 Monitor Arbeitsplatz inkl. Tastaturablage und Abdeckung Kabelführung 1 Montage-Flansch inkl. Bolzen und Abdeckkappe 1 Schraube DIN 912 - M8 x 45 (für Nutenstein) 1 Schraube DIN 912 - M8 x 50 (für Kernloch) 1 Scheibe 8-FSt 1 Nutfixierungsplatte - Nut 8 1 Nutfixierungsplatte - Nut 10 1 Nutenstein - Nut 8 - M8 1 Nutenstein - Nut 10 - M8
Pack Quantity	1 piece	Liefereinheit	1 Stück

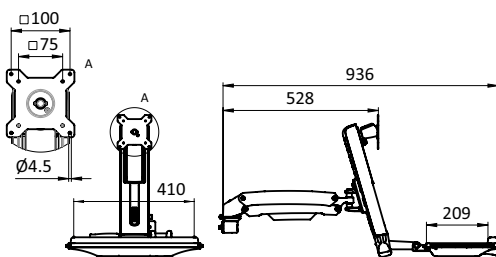

**MONITOR WORK STATION SIT / STAND 4-AXIS,
 PROFILE ATTACHMENT (SET)**

**MONITOR ARBEITSPLATZ SIT / STAND 4 ACHSEN,
 PROFILBEFESTIGUNG (SET)**

Monitor Work Station SIT / STAND 4-axis, Profile Attachment (Set)
 Monitor Arbeitsplatz SIT / STAND 4 Achsen, Profilbefestigung (Set)

	N	Weight [g] Gewicht [g]	Profile Profil	Part # Teil-Nr.
	- / 8 / 10	9200.0	I	6MHM75100S40IT

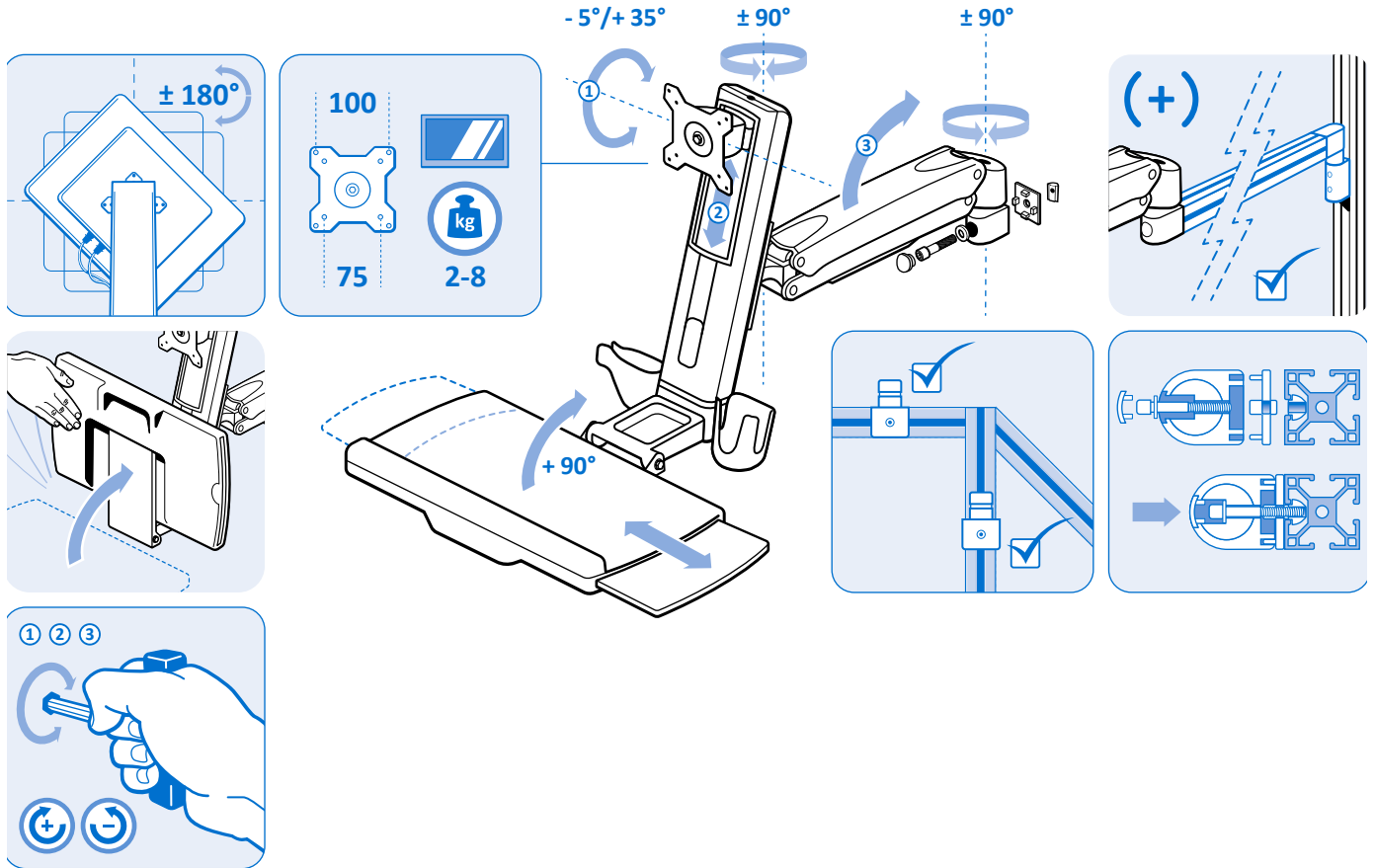



MATERIAL TRANSPORT *MATERIALTRANSPORT*

VISUAL MANAGEMENT *VISUAL MANAGEMENT*

Container Labelings
Behälterkennzeichnungen 1

Shelf Labelings
Regalkennzeichnungen 2

Floor Markings
Bodenmarkierungen 3

Stickers
Aufkleber 4

Inserting Systems
Einstecksysteme 5

Visual Boards
Visual Boards 6

Material Transport
Materialtransport 7

Material Supply
Materialbereitstellung 8

simply
practical

FATH[®]
COMPONENTS



DOLLIES BODENROLLER

FORKLIFT-FREE
MATERIAL TRANSPORT
STAPLERFREIER
MATERIALTRANSPORT

OPTIMIZED MATERIAL TRANSPORT: REDUCE SPACE REQUIREMENTS THANKS TO THE ABILITY TO TARGET PROVISIONS EXACTLY WHERE NEEDED WITH FATH DOLLIES
OPTIMIERTER MATERIALTRANSPORT: REDUZIERTER PLATZBEDARF DURCH GEZIELTE BEREITSTELLUNG MIT DEN FATH BODENROLLERN

The FATH dollies are a perfect fit for all small load carriers/Euro containers and offer maximum flexibility for in-house material transport.

Do you still move your products with forklifts?
Do you provide materials on Euro pallets?
Do you supply your assembly or production lines from a central location?

If you answer yes to any of the above questions, **FATH** would be happy to assist you with moving towards a forklift-free production facility.

Typical advantages of highly efficient material supply using dollies include:

- Small/medium batch sizes in production/assembly
- Reduction in material retrievals
- Large variety
- Less staging area required

Die FATH Bodenroller sind passgenau für alle KLT/Eurobehälter und stehen für höchste Flexibilität beim innerbetrieblichen Materialtransport.

*Sie bewegen Ihre Produkte noch mit Gabelstaplern?
Sie stellen Materialien auf Europaletten bereit?
Sie versorgen Ihre Montage- oder Fertigungslinien von einem zentralen Ort?*

Wenn Sie eine dieser Fragen mit ja beantworten, unterstützen wir Sie gerne auf dem Weg zu einer staplerfreien Fertigung.

Typische Faktoren, die für eine hocheffiziente Materialversorgung mittels Bodenroller sprechen:

- *Kleine/mittlere Losgrößen in Produktion/Montage*
- *Geringe Materialabrufe*
- *Große Variantenvielfalt*
- *Weniger Bereitstellungsfläche erforderlich*



**FATH OFFERS DOLLIES WITH A VARIETY OF DESIGNS FOR A WIDE VARIETY OF REQUIREMENTS.
FATH BIETET BODENROLLER MIT EINER VIELZAHL AN AUSFÜHRUNGEN FÜR DIE UNTERSCHIEDLICHSTEN
ANFORDERUNGEN.**

Possible variants:

- 4 swivel castors
- 2 swivel castors and 2 fixed castors
- Drawbar systems suitable for tugger trains
- Wheels for all areas of application

Mögliche Varianten:

- 4 Lenkrollen
- 2 Lenkrollen und 2 Bockrollen
- Routenzug taugliche Deichselsysteme
- Räder für alle Anwendungsbereiche

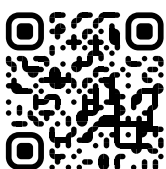

You would like to know more
about the FATH Dollies?

dolly.fath24.com

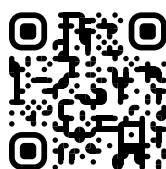

Sie möchten die FATH Bodenroller
besser kennen lernen?

bodenroller.fath24.de



MATERIAL SUPPLY *MATERIALBEREITSTELLUNG*

VISUAL MANAGEMENT *VISUAL MANAGEMENT*

Container Labelings
Behälterkennzeichnungen 1

Shelf Labelings
Regalkennzeichnungen 2

Floor Markings
Bodenmarkierungen 3

Stickers
Aufkleber 4

Inserting Systems
Einstecksysteme 5

Visual Boards
Visual Boards 6

Material Transport
Materialtransport 7

**Material Supply
Materialbereitstellung 8**

	Parking Rail Low / Low (Set) <i>Parkschiene flach / flach (Set)</i>	157		Infeed Cap for Guiding Rail FIFO (Set) <i>Einführungskappe für Führungsschiene FIFO (Set)</i>	172
	Parking Rail Low / High (Set) <i>Parkschiene flach / hoch (Set)</i>	158		Screw Cover Infeed Cap for Guiding Rail FIFO <i>Schraubenabdeckung Einführungskappe für Führungsschiene FIFO</i>	173
	Parking Rail High / High (Set) <i>Parkschiene hoch / hoch (Set)</i>	159		Connecting Element for Guiding Rail FIFO (Set) <i>Verbindungsblech für Führungsschiene FIFO (Set)</i>	174
	End Cap for Parking Rail Low / Low (Set) <i>Endkappe für Parkschiene flach / flach (Set)</i>	160		Connecting Strip 140 I, Slot 8 <i>Streckenverbinder 140 I, Nut 8</i>	175
	End Cap for Parking Rail Low / High (Set) <i>Endkappe für Parkschiene flach / hoch (Set)</i>	161		Cover Profile Slot 8 - 4.5 <i>Abdeckprofil Nut 8 - 4,5</i>	176
	End Cap for Parking Rail High / High (Set) <i>Endkappe für Parkschiene hoch / hoch (Set)</i>	162		Automatic Connector Steel <i>Automatikverbinder Stahl</i>	177
	End Cap XL for Parking Rail Low / High (Set) <i>Endkappe XL für Parkschiene flach / hoch (Set)</i>	163		Automatic Double Connector I, Slot 8 (Set) <i>Automatik-Doppelverbinder I, Nut 8 (Set)</i>	178
	End Cap XL for Parking Rail High / High (Set) <i>Endkappe XL für Parkschiene hoch / hoch (Set)</i>	164		Plate Connector I ZN 40 (Set) <i>Plattenverbinder I ZN 40 (Set)</i>	179
	Position Marking End Cap for Parking Rail <i>Positionsmarkierung Endkappe für Parkschiene</i>	165		Zinc Connection Angle 40 flat <i>Zinkwinkel 40 flach</i>	180
	Guiding Rail FIFO (Set) <i>Führungsschiene FIFO (Set)</i>	171		Zinc Connection Angle 40 / 80 flat <i>Zinkwinkel 40 / 80 flach</i>	181



Milling Connector I, Slot 8
Fräsverbinder I, Nut 8

182



Roll-in T-slot Nut 13.5 x 7.2 mm
with Spring Loaded Ball
*Nutenstein 13,5 x 7,2 mm,
einschwenkbar mit Federkugel*

183

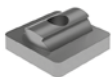

Adapter Plate D28
Adapterplatte D28

184



T-connector Plate D28
T-Verbinderplatte D28

185



Roller Track XST R28
Rollenschiene XST R28

186



Roller Track XST R28 mit Spurkranz
Rollenschiene XST R28 with Flange

187



Roller Track XST H26
Rollenschiene XST H26

188



Holding Bracket ST D28
Einhängehalter ST D28

189



Variable Holding Bracket ST D28
Variabler Halter ST D28

190



Mounting Bracket ST D28
Montagehalter ST D28

191

1

2

3

4

5

6

7

8

simply
practical

FATH®
COMPONENTS



PARKING RAILS (SET) PARKSCHIENEN (SET)

PRECISE POSITIONING
PUNKTGENAUE POSITIONIERUNG

FATH PARKING RAILS: PRECISE, SPACE-SAVING AND SAFE POSITIONING OF DOLLIES FATH PARKSCHIENEN: BODENROLLER PUNKTGENAU, PLATZSPAREND UND SICHER POSITIONIEREN

The clever Lean product for more structure and efficiency in material supply

- Precise positioning of dollies and wagons
- Clear order in material management
- Efficient use of space
- More safety in the shopfloor area
- Easy installation: place, glue down, ready to use
- One-piece signal end caps are separately available

- **SECURE**
- **EASY INSTALLATION**
- **SIGNAL EFFECT**

Das clevere Lean-Produkt für mehr Struktur und Effizienz in der Materialbereitstellung

- Punktgenaue Positionierung von Bodenrollern und Wägen
- Klare Ordnung bei der Materialzufuhr
- Effiziente Raumnutzung
- Mehr Sicherheit im Produktionsbereich
- Einfache Montage: auflegen, festkleben, fertig
- Einteilige Signal-Endkappen separat erhältlich

- **SICHER**
- **EINFACHE MONTAGE**
- **SIGNALWIRKUNG**



THAT'S LEAN: PRECISE POSITIONING AND LEAN SPACE UTILIZATION DAS IST LEAN: PUNKTGENAUE POSITIONIERUNG UND SCHLANKE FLÄCHENNUTZUNG

Lean your production processes in a simple way with the **FATH** parking rails. The parking rails mark the exact parking positions for dollies or in-house trolleys.

By driving onto the rails, each employee automatically parks the wagons always accurately at the right position.

The required material is thus immediately available in the movement and gripping space of the assembly worker – targeted, structured and always in the right quantity. Even when robots are used, the parking rails ensure precise material supply. A waste of space is avoided by the orderly use of the floor and adjoining processes are not disturbed due to the low construction height of 6 to 10 mm – if no dollies are parked, the space can be freely used. High loads, such as driving over with industrial trucks, are no problem for the robust aluminum rails.

Verschanken Sie mit den **FATH** Parkschiene Ihre Produktionsprozesse auf einfache Weise. Die Parkschiene markieren die vorgesehenen Parkpositionen für Bodenroller oder betriebseigene Rollwägen.

Durch Auffahren auf die Schiene parkt jeder Mitarbeiter die Wägen automatisch immer punktgenau an der exakten Position.

Das benötigte Material steht somit unmittelbar im Bewegungs- und Greifraum des Montagearbeiters zur Verfügung – gezielt, strukturiert und immer in der richtigen Menge. Auch wenn Roboter eingesetzt werden, sorgen die Parkschiene für eine präzise Materialbereitstellung. Eine Flächenverschwendung wird durch die geordnete Bodennutzung vermieden und angrenzende Prozesse werden aufgrund der geringen Aufbauhöhe von 6 bis 10 mm nicht behindert – wenn keine Bodenroller geparkt werden, kann der Raum beliebig genutzt werden. Hohe Belastungen, wie das Überfahren mit Flurförderfahrzeugen, sind für die robusten Aluschiene dabei kein Problem.

READY TO USE! SIMPLE INSTALLATION WITHOUT TOOL READY TO USE! EINFACHE MONTAGE OHNE WERKZEUG

The aluminum parking rails from **FATH** are underside coated with a high-performance industrial glue that guarantees extremely high adhesion.

Remove the protective film, lay on the parking rails, stick the rails onto the floor over their entire surface – that's it!

Small uneven areas in the floor and expansion gaps are compensated by the adhesive. The different height versions of the parking rails are designed for the different loads of the dollies.

This guarantees easy entry and exit as well as a secure hold for lighter and heavy dollies. Since the resistance when driving onto the rails is very low, the handling of the floor rollers is smooth and protects the back – a plus for ergonomics at the work place.

The parking rails consist of two rail halves and can be adapted to the roller size of the trolleys by selecting the appropriate distance.

Die Aluminium-Parkschienen von FATH sind an den Unterseiten mit einem Industrie-Hochleistungskleber versehen, der eine extrem hohe Haftung garantiert.

Schutzfolie abziehen, Parkschienen auflegen, Schienen vollflächig auf den Boden kleben – fertig!

Kleinere Unebenheiten im Boden und Dehnungsfugen werden durch den Kleber ausgeglichen. Die verschiedenen Höhenausführungen der Parkschienen sind auf die unterschiedliche Beladung der Bodenroller abgestimmt.

Dies gewährleistet das einfache Ein- und Ausparken sowie sicheren Halt für leichtere und schwere Bodenroller. Da der Widerstand beim Auffahren auf die Schienen sehr gering ist, erfolgt das Handling der Bodenroller fließend und rückschonend – ein Plus für die Ergonomie am Arbeitsplatz.

Die Parkschienen bestehen aus zwei Schienenhälften und lassen sich durch entsprechende Wahl des Abstands an die Rollengröße der Wägen anpassen.



MORE SAFETY: DEFINED PARKING POSITION AND SIGNAL EFFECT MEHR SICHERHEIT: DEFINIERTE PARKPOSITION UND SIGNALWIRKUNG

The parking rails secure the floor rollers against unintentional rolling away from the work station. When filling or removing material, the trolleys are reliably held in position – even on uneven floors, without brakes on the rollers. Driveways and walkways remain free and production areas easily accessible.

Groundbreaking: Bright yellow triangles in the end caps indicate the exact position of the parking rails to the worker.

A detail that simplifies material supply efficiency and provides additional safety. Regardless of the rail height, the end caps are inserted into the side of the rail ends and close them completely.

The undersides can also be completely glued to the floor, which prevents the ingress of dirt and makes the parking rails suitable for clean rooms.

Die Parkschienen sichern die Bodenroller gegen unbeabsichtigtes Wegrollen vom Arbeitsplatz. Beim Befüllen oder der Entnahme von Material werden die Wägen zuverlässig in der Position gehalten – selbst bei unebenen Böden, ohne Feststeller an den Rollen. Fahr- und Gehwege bleiben frei und Produktionsbereiche gut zugänglich.

Wegweisend: Leuchtend gelbe Dreiecke in den Endkappen signalisieren dem Werker die exakte Lage der Parkschienen.

Ein Detail, das die Effizienz bei der Materialzuführung vereinfacht und für zusätzliche Sicherheit sorgt. Unabhängig von der Schienenhöhe werden die Endkappen seitlich in die Schienenenden eingesteckt und schließen diese vollständig ab.

Die Unterseiten können ebenfalls vollständig mit dem Boden verklebt werden, was das Eindringen von Verunreinigungen verhindert und die Parkschienen reinraumtauglich macht.

THE FATH PARKING RAILS (SET) ARE AVAILABLE IN 3 VERSIONS
DIE FATH PARKSCHIENEN (SET) SIND IN 3 AUSFÜHRUNGEN ERHÄLTlich

Modular lengths 400, 800, 1200 and 2400 mm
 Rasterlängen 400, 800, 1200 und 2400 mm



<p>HIGH: For light to medium weights</p> <p><i>HOCH:</i> <i>Für leichte bis mittlere Gewichte</i></p>	<p>LOW – HIGH: For medium to heavy weights</p> <p><i>FLACH – HOCH:</i> <i>Für mittlere bis schwere Gewichte</i></p>	<p>LOW: For heavy weights</p> <p><i>FLACH:</i> <i>Für schwere Gewichte</i></p>
<p>The high version, both sides 10 mm high, is particularly suitable for light and medium weights. Dollies can be moved onto and off the parking rail from both sides and find a secure hold.</p> <p><i>Die beidseitig hohe Ausführung mit jeweils 10 mm Höhe ist besonders für leichte und mittlere Gewichte geeignet. Bodenroller können von beiden Seiten in die Parkschiene ein- und ausgefahren werden und finden sicheren Halt.</i></p>	<p>The low – high version with 6 mm / 10 mm provides a well noticeable starting resistance and thus simplifies the positioning of the dollies in the parking rail. Pulling the ground rollers out over the low side is back-friendly, even with high weights, as only little force is required.</p> <p><i>Die flach – hohe Ausführung mit 6 mm / 10 mm sorgt für einen gut wahrnehmbaren Anfahrwiderstand und vereinfacht somit das Positionieren der Bodenroller in der Parkschiene. Das Herausschieben der Bodenroller über die flache Seite ist selbst bei hohen Gewichten besonders rückschonend, da nur ein geringer Kraftaufwand erforderlich ist.</i></p>	<p>In the low version, both sides 6 mm high, heavy loads or loads that are difficult to manoeuvre, such as rollable garbage containers, can be effortlessly parked and unparked in both directions.</p> <p><i>In der beidseitig flachen Ausführung mit jeweils 6 mm Höhe können schwere oder schlecht zu manövrierende Lasten, wie z.B. rollbare Müllcontainer, zu beiden Richtungen mühelos geparkt und ausgeparkt werden.</i></p>



ACCESSORIES ZUBEHÖR

One of its kind on the market: one-piece end caps

The self-adhesive end caps consist of a single piece—simply attach the end caps and press them to the bottom. Locking lugs ensure immediate correct positioning. Fully covered with adhesive preventing penetration of moisture, dirt and impurities—no screwing and drilling at the floor needed.

The one-piece end caps are available in five complete sets for each parking rail design:

- End Cap (Set) High
- End Cap (Set) High enlarged version; widening for larger wheel diameters
- End Cap (Set) Low – High
- End Cap (Set) Low – High enlarged version; widening for larger wheel diameters
- End Cap (Set) Low

Integrated brightly colored position marking

A yellow triangle Position marking is integrated directly into the end caps. This visual border eliminates the need for time-consuming gluing of the aluminum rails with yellow/black marking tape. The markings at the ends caps serve as an optical drive-in aid for easy positioning of the Trolleys. The flat tapered End Caps in conjunction with the signal triangle minimize the risk of tripping.

FATH offers a range of swivel castors and fixed castors designed for connection to aluminum profiles for the construction of your own trolleys.



Einzigartig am Markt: Einteilige Endkappen

Die selbstklebenden Endkappen bestehen aus einem einzigen Stück – Endkappen einfach aufstecken und am Boden andrücken. Arretierungsnasen sorgen für die sofortige richtige Positionierung. Die Unterseiten sind mit industrietauglichem Kleber ausgestattet. Durch die Verklebung wird das Eindringen von Verunreinigungen verhindert – und Ihr Hallenboden wird nicht durch Bohrlöcher beschädigt.

Die einteiligen Endkappen sind in fünf vollständigen Sets für jede Parkschiene-Ausführung erhältlich:

- *Endkappen (Set) hoch*
- *Endkappen (Set) hoch, mit Parkschieneabstand für große Raddurchmesser*
- *Endkappen (Set) flach – hoch*
- *Endkappen (Set) flach – hoch, mit Parkschieneabstand für große Raddurchmesser*
- *Endkappen (Set) flach*

Integrierte Positionsmarkierung in Signalfarbe

Eine Positionsmarkierung in Form eines Dreiecks in gelber Signalfarbe ist direkt in den Endkappen integriert. Diese visuelle Randbegrenzung macht ein aufwändiges Bekleben der Aluschienen mit gelb/schwarzem Markierungsband überflüssig. Zudem dienen die Markierungen an den Endkappen als optische Einfahrhilfe für die einfache Positionierung der Rollwagen. Die flach auslaufenden Endkappen minimieren in Verbindung mit dem Signal-Dreieck die Stolpergefahr.

Zum Bau Ihrer eigenen Rollwagen bietet FATH ein auf die Anbindung an Aluminiumprofile abgestimmtes Programm an Lenk- und Bockrollen.



You would like to know more about the FATH Parking Rails?

parking-rail.fath24.com

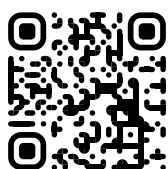

Sie möchten die FATH Parkschienen besser kennen lernen?

parkschiene.fath24.de

PARKING RAIL LOW / LOW (SET)

PARKSCHIENE FLACH / FLACH (SET)

Model	Low / low, for heavy weights	Ausführung	flach / flach, für schwere Gewichte
Description	For precise positioning of dollies or material trolleys, suitable for different wheel diameters, no brakes needed; self-adhesive, for tool-free assembly, no screwing required, immediately ready for use	Beschreibung	zum punktgenauen Positionieren von Bodenrollern oder Materialwägen, für unterschiedliche Rollendurchmesser geeignet, keine Bremsen notwendig; selbstklebend, zur werkzeuglosen Montage, kein Verschrauben notwendig, sofort einsatzbereit
Material	Aluminum	Material	Aluminium
Surface	Plain	Oberfläche	blank
Fastening	Self-adhesive surface on the backside	Befestigung	mit rückseitiger Selbstklebefläche
Pack Quantity	1 set (= 2 pieces)	Liefereinheit	1 Set (= 2 Stück)
Tip	Compatible end cap for wheel diameter < 100 mm see 02084LLS01	Hinweis	passende Endkappe für Raddurchmesser < 100 mm siehe 02084LLS01

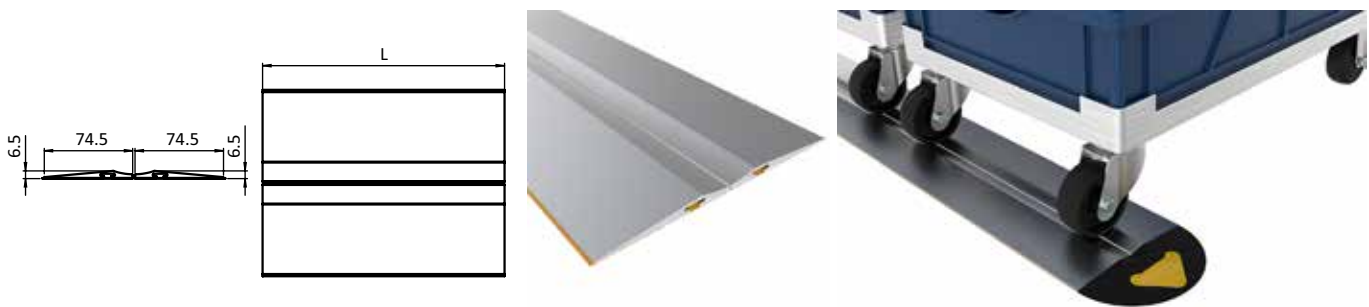

Parking Rail Low / Low (Set) Parkschiene flach / flach (Set)	L [mm]	Weight [g] Gewicht [g]	Part # Teil-Nr.
	400.0	520.0	02081ALL.0400
	800.0	1060.0	02081ALL.0800
	1200.0	1580.0	02081ALL.1200
	2400.0	3200.0	02081ALL.2400

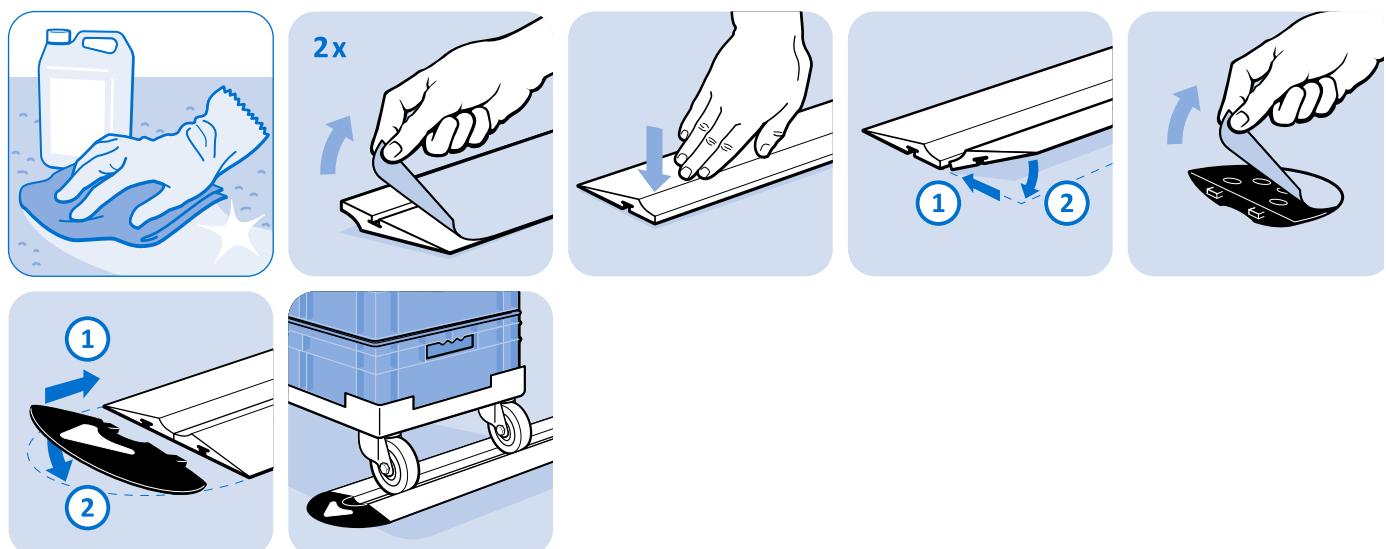

PARKING RAIL LOW / HIGH (SET)

PARKSCHIENE FLACH / HOCH (SET)

<p>Model Low / high, for medium to heavy weights</p> <p>Description For precise positioning of dollies or material trolleys, suitable for different wheel diameters, no brakes needed; self-adhesive, for tool-free assembly, no screwing required, immediately ready for use</p> <p>Material Aluminum</p> <p>Surface Plain</p> <p>Fastening Self-adhesive surface on the backside</p> <p>Pack Quantity 1 set (= 2 pieces)</p> <p>Tip Compatible end cap for wheel diameter < 100 mm see 02084LHS01, compatible end cap XL for wheel diameter > 100 mm see 02084LHXL01</p>	<p>Ausführung flach / hoch, für mittlere bis schwere Gewichte</p> <p>Beschreibung zum punktgenauen Positionieren von Bodenrollern oder Materialwägen, für unterschiedliche Rollendurchmesser geeignet, keine Bremsen notwendig; selbstklebend, zur werkzeuglosen Montage, kein Verschrauben notwendig, sofort einsatzbereit</p> <p>Material Aluminium</p> <p>Oberfläche blank</p> <p>Befestigung mit rückseitiger Selbstklebefläche</p> <p>Liefereinheit 1 Set (= 2 Stück)</p> <p>Hinweis passende Endkappe für Raddurchmesser < 100 mm siehe 02084LHS01, passende Endkappe XL für Raddurchmesser > 100 mm siehe 02084LHXL01</p>
---	---



Parking Rail Low / High (Set) Parkschiene flach / hoch (Set)	L [mm]	Weight [g] Gewicht [g]	Part # Teil-Nr.
	400.0	570.0	02081ALH.0400
	800.0	1120.0	02081ALH.0800
	1200.0	1750.0	02081ALH.1200
	2400.0	3500.0	02081ALH.2400

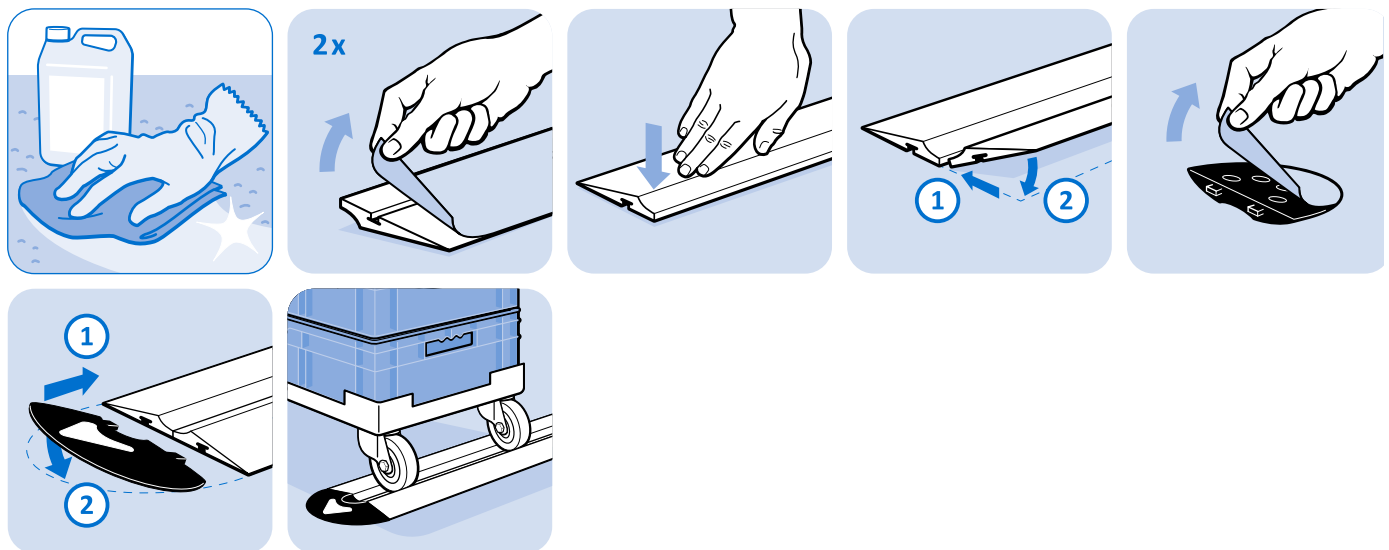

PARKING RAIL HIGH / HIGH (SET)

PARKSCHIENE HOCH / HOCH (SET)

Model	High / high, for light to medium weights	Ausführung	hoch / hoch, für leichte bis mittlere Gewichte
Description	For precise positioning of dollies or material trolleys, suitable for different wheel diameters, no brakes needed; self-adhesive, for tool-free assembly, no screwing required, immediately ready for use	Beschreibung	zum punktgenauen Positionieren von Bodenrollern oder Materialwägen, für unterschiedliche Rollendurchmesser geeignet, keine Bremsen notwendig; selbstklebend, zur werkzeuglosen Montage, kein Verschrauben notwendig, sofort einsatzbereit
Material	Aluminum	Material	Aluminium
Surface	Plain	Oberfläche	blank
Fastening	Self-adhesive surface on the backside	Befestigung	mit rückseitiger Selbstklebefläche
Pack Quantity	1 set (= 2 pieces)	Liefereinheit	1 Set (= 2 Stück)
Tip	Compatible end cap for wheel diameter < 100 mm see 02084HHS01, compatible end cap XL for wheel diameter > 100 mm see 02084HHXLS01	Hinweis	passende Endkappe für Raddurchmesser < 100 mm siehe 02084HHS01, passende Endkappe XL für Raddurchmesser > 100 mm siehe 02084HHXLS01



Parking Rail High / High (Set) Parkschiene hoch / hoch (Set)	L [mm]	Weight [g] Gewicht [g]	Part # Teil-Nr.
	400.0	600.0	02081AHH.0400
	800.0	1200.0	02081AHH.0800
	1200.0	1800.0	02081AHH.1200
	2400.0	3600.0	02081AHH.2400

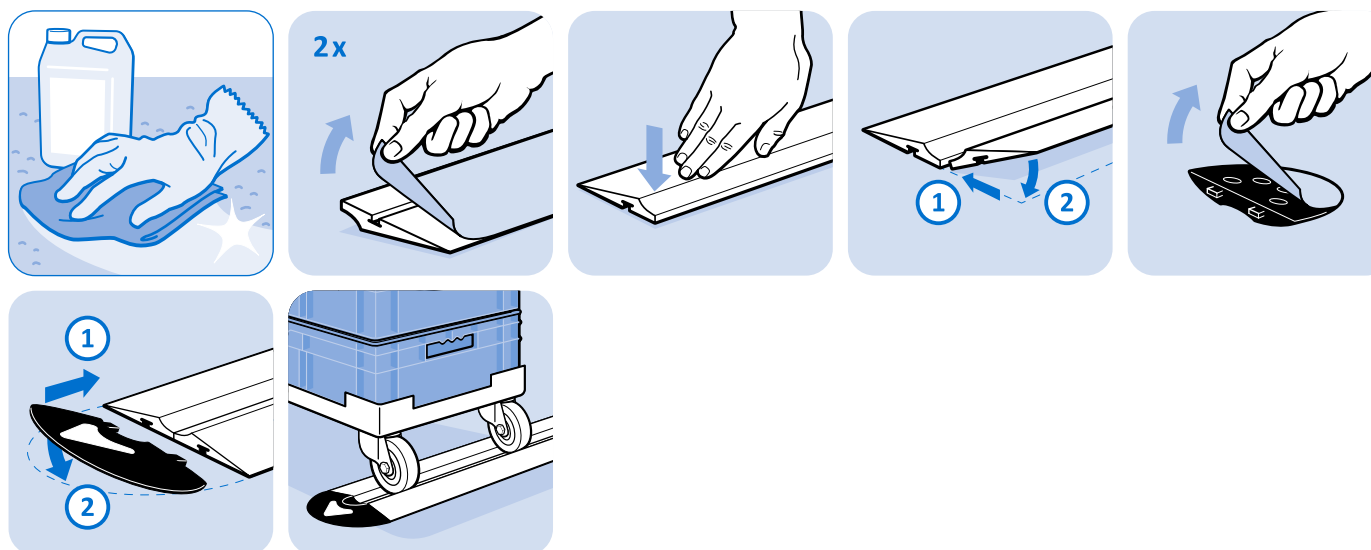

END CAP FOR PARKING RAIL LOW / LOW (SET)

ENDKAPPE FÜR PARKSCHIENE FLACH / FLACH (SET)

Model	Standard version, for wheel diameter < 100 mm	Ausführung	normale Ausführung, für Raddurchmesser < 100 mm
Description	One-piece end caps; self-adhesive; Yellow position markings with signal effect to indicate the position of the wheels from floor dollies or material trolleys in the parking rail	Beschreibung	einteilige Endkappen; selbstklebend; gelbe Positionsmarkierungen mit Signalwirkung zur Anzeige der Position der Räder von Bodenrollern oder Materialwägen in der Parkschiene
Material	End caps: Plastic PA, glass ball reinforced Position markings: Plastic PET	Material	Endkappen: Kunststoff PA, glaskugelverstärkt Positionsmarkierungen: Kunststoff PET
Color	End caps: black Position markings: yellow ≈ RAL 1003 Screw-on set (optional) plastic anchor: Yellow	Farbe	Endkappen: schwarz Positionsmarkierungen: gelb ≈ RAL 1003 Anschraubset (optional) Dübel: gelb
Set	2 end caps 2 position markings	Set	2 Endkappen 2 Positionsmarkierungen
Fastening	Self-adhesive surface on the backside	Befestigung	mit rückseitiger Selbstklebefläche
Pack Quantity	1 set (= 2 pieces)	Liefereinheit	1 Set (= 2 Stück)
Tip	Compatible parking rail low / low (set) for heavy weights see 02081ALL.0400, Compatible position marking as replacement see 02084S.15	Hinweis	passende Parkschiene flach / flach (Set) für schwere Gewichte siehe 02081ALL.0400, passende Positionsmarkierung als Ersatz siehe 02084S.15

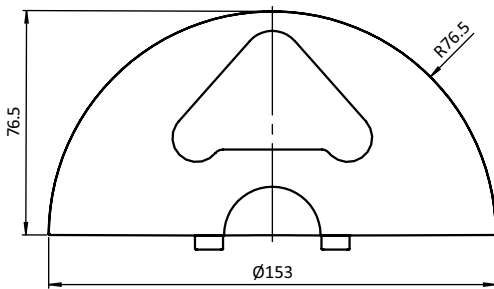

End Cap for Parking Rail Low / Low (Set)
 Endkappe für Parkschiene flach / flach (Set)

for Wheel Diameter
 für Raddurchmesser

Weight [g]
 Gewicht [g]

Part #
 Teil-Nr.

< 100 mm

66.0

02084LLS01

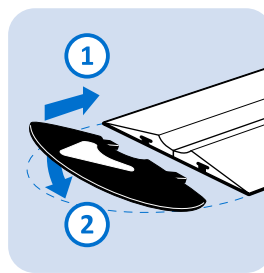
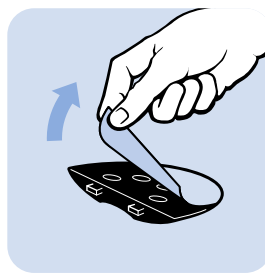

END CAP FOR PARKING RAIL LOW / HIGH (SET)

ENDKAPPE FÜR PARKSCHIENE FLACH / HOCH (SET)

<p>Model Standard version, for wheel diameter < 100 mm</p> <p>Description One-piece end caps; self-adhesive; Yellow position markings with signal effect to indicate the position of the wheels from floor dollies or material trolleys in the parking rail</p> <p>Material End caps: Plastic PA, glass ball reinforced Position markings: Plastic PET</p> <p>Color End caps: black Position markings: yellow ≈ RAL 1003 Screw-on set (optional) plastic anchor: Yellow</p> <p>Set 2 end caps 2 position markings</p> <p>Fastening Self-adhesive surface on the backside</p> <p>Pack Quantity 1 set (= 2 pieces)</p> <p>Tip Compatible parking rail low / high (set) for medium to heavy weights see 02081ALH.0400, Compatible position marking as replacement see 02084S.15</p>	<p>Ausführung normale Ausführung, für Raddurchmesser < 100 mm</p> <p>Beschreibung einteilige Endkappen; selbstklebend; gelbe Positionsmarkierungen mit Signalwirkung zur Anzeige der Position der Räder von Bodenrollern oder Materialwägen in der Parkschiene</p> <p>Material Endkappen: Kunststoff PA, glaskugelverstärkt Positionsmarkierungen: Kunststoff PET</p> <p>Farbe Endkappen: schwarz Positionsmarkierungen: gelb ≈ RAL 1003 Anschraubset (optional) Dübel: gelb</p> <p>Set 2 Endkappen 2 Positionsmarkierungen</p> <p>Befestigung mit rückseitiger Selbstklebefläche</p> <p>Liefereinheit 1 Set (= 2 Stück)</p> <p>Hinweis passende Parkschiene flach / hoch (Set) für mittlere bis schwere Gewichte siehe 02081ALH.0400, passende Positionsmarkierung als Ersatz siehe 02084S.15</p>
---	---

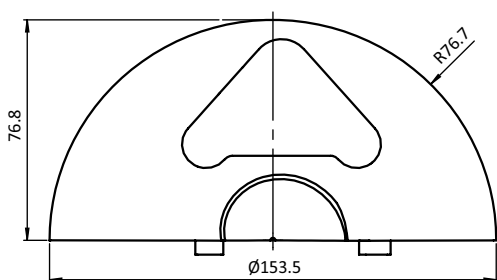

End Cap for Parking Rail Low / High (Set) <i>Endkappe für Parkschiene flach / hoch (Set)</i>	for Wheel Diameter <i>für Raddurchmesser</i>	Weight [g] <i>Gewicht [g]</i>	Part # <i>Teil-Nr.</i>
	< 100 mm	80.0	02084LHS01

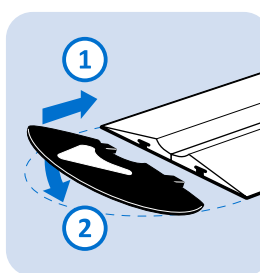
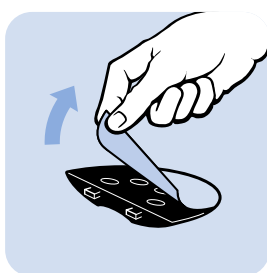

END CAP FOR PARKING RAIL HIGH / HIGH (SET)

ENDKAPPE FÜR PARKSCHIENE HOCH / HOCH (SET)

Model	Standard version, for wheel diameter < 100 mm	Ausführung	normale Ausführung, für Raddurchmesser < 100 mm
Description	One-piece end caps; self-adhesive, screwable with optional screw-on set; Yellow position markings with signal effect to indicate the position of the wheels from floor dollies or material trolleys in the parking rail	Beschreibung	einteilige Endkappen; selbstklebend, anschraubbar mit optionalem Anschraubset; gelbe Positionsmarkierungen mit Signalwirkung zur Anzeige der Position der Räder von Bodenrollern oder Materialwägen in der Parkschiene
Material	End caps: Plastic PA, glass ball reinforced Position markings: Plastic PET Screw-on set (optional) screw: Steel Screw-on set (optional) plastic anchor: Plastic	Material	Endkappen: Kunststoff PA, glaskugelverstärkt Positionsmarkierungen: Kunststoff PET Anschraubset (optional) Schraube: Stahl Anschraubset (optional) Dübel: Kunststoff
Surface	Screw-on set (optional) screw: Zinc Plated	Oberfläche	Anschraubset (optional) Schraube: verzinkt
Color	End caps: black Position markings: yellow ≈ RAL 1003 Screw-on set (optional) plastic anchor: Yellow	Farbe	Endkappen: schwarz Positionsmarkierungen: gelb ≈ RAL 1003 Anschraubset (optional) Dübel: gelb
Set	2 end caps 2 position markings	Set	2 Endkappen 2 Positionsmarkierungen
Assembly Set	1 screw-on set (optional): 4 board screws, 4 plastic anchors, 2 position markings	Montageset	1 Anschraubset (optional): 4 Schrauben, 4 Dübel, 2 Positionsmarkierungen
Fastening	Self-adhesive surface on the backside	Befestigung	mit rückseitiger Selbstklebefläche
Pack Quantity	1 set (= 2 pieces)	Liefereinheit	1 Set (= 2 Stück)
Tip	Compatible parking rail high / high (set) for light to medium weights see 02081AHH.0400, Compatible position marking as replacement see 02084S.15	Hinweis	passende Parkschiene hoch / hoch (Set) für leichte bis mittlere Gewichte siehe 02081AHH.0400, passende Positionsmarkierung als Ersatz siehe 02084S.15

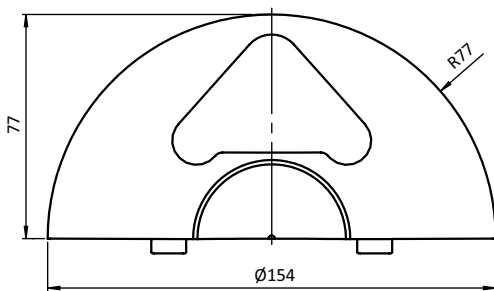

End Cap for Parking Rail High / High (Set)
 Endkappe für Parkschiene hoch / hoch (Set)

for Wheel Diameter
 für Raddurchmesser

Weight [g]
 Gewicht [g]

Part #
 Teil-Nr.

	< 100 mm	70.0	02084HHS01
Srew-on Set End Cap for Parking Rail <i>Anschraubset Endkappe für Parkschiene</i>		47.0	02084R01

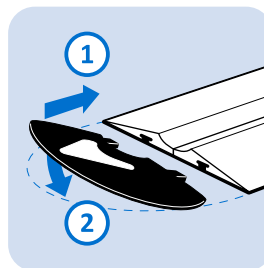
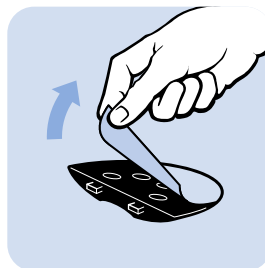

END CAP XL FOR PARKING RAIL LOW / HIGH (SET)

ENDKAPPE XL FÜR PARKSCHIENE FLACH / HOCH (SET)

<p>Model XL version, for wheel diameter > 100 mm</p> <p>Description One-piece XL end caps, no spacers required for large wheel diameters; self-adhesive; Yellow position markings with signal effect to indicate the position of the wheels from floor dollies or material trolleys in the parking rail</p> <p>Material End caps: Plastic PA, glass ball reinforced Position markings: Plastic PET</p> <p>Color End caps: black Position markings: yellow ≈ RAL 1003 Screw-on set (optional) plastic anchor: Yellow</p> <p>Set 2 XL end caps 2 position markings</p> <p>Fastening Self-adhesive surface on the backside</p> <p>Pack Quantity 1 set (= 2 pieces)</p> <p>Tip Compatible parking rail low / high (set) for medium to heavy weights see 02081ALH.0400, Compatible position marking as replacement see 02084S.15</p>	<p>Ausführung XL-Ausführung, für Raddurchmesser > 100 mm</p> <p>Beschreibung einteilige XL-Endkappen, keine Distanzstücke für große Raddurchmesser notwendig; selbstklebend; gelbe Positionsmarkierungen mit Signalwirkung zur Anzeige der Position der Räder von Bodenrollern oder Materialwägen in der Parkschiene</p> <p>Material Endkappen: Kunststoff PA, glaskugelverstärkt Positionsmarkierungen: Kunststoff PET</p> <p>Farbe Endkappen: schwarz Positionsmarkierungen: gelb ≈ RAL 1003 Anschraubset (optional) Dübel: gelb</p> <p>Set 2 XL Endkappen 2 Positionsmarkierungen</p> <p>Befestigung mit rückseitiger Selbstklebefläche</p> <p>Liefereinheit 1 Set (= 2 Stück)</p> <p>Hinweis passende Parkschiene flach / hoch (Set) für mittlere bis schwere Gewichte siehe 02081ALH.0400, passende Positionsmarkierung als Ersatz siehe 02084S.15</p>
--	--

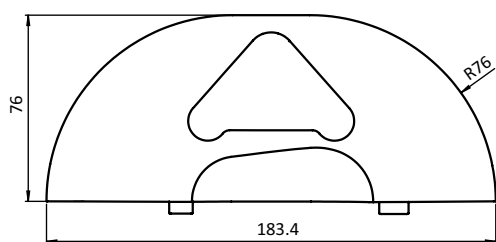

End Cap XL for Parking Rail Low / High (Set)
 Endkappe XL für Parkschiene flach / hoch (Set)

for Wheel Diameter
 für Raddurchmesser

Weight [g]
 Gewicht [g]

Part #
 Teil-Nr.

> 100 mm

100.0

02084LHXL01

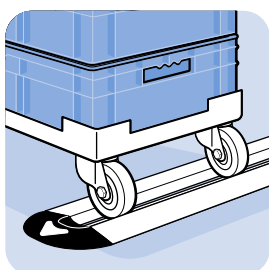
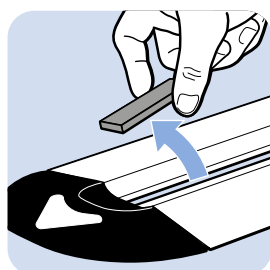
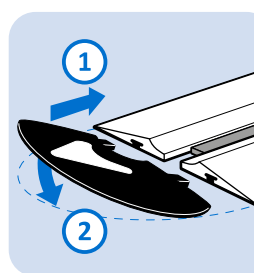
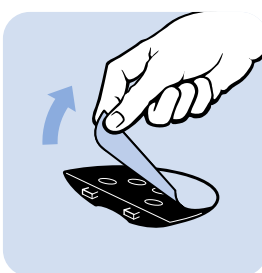
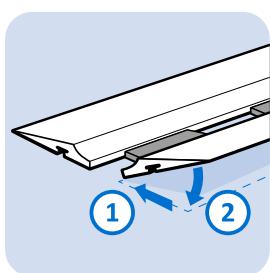
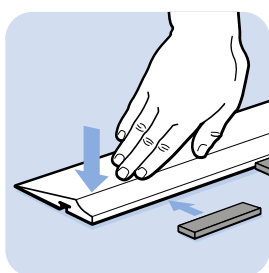

END CAP XL FOR PARKING RAIL HIGH / HIGH (SET)

ENDKAPPE XL FÜR PARKSCHIENE HOCH / HOCH (SET)

Model	XL version, for wheel diameter > 100 mm	Ausführung	XL-Ausführung, für Raddurchmesser > 100 mm
Description	One-piece XL end caps, no spacers required for large wheel diameters; self-adhesive, screwable with optional screw-on set; Yellow position markings with signal effect to indicate the position of the wheels from floor dollies or material trolleys in the parking rail	Beschreibung	einteilige XL-Endkappen, keine Distanzstücke für große Raddurchmesser notwendig; selbstklebend, anschaubar mit optionalem Anschraubset; gelbe Positionsmarkierungen mit Signalwirkung zur Anzeige der Position der Räder von Bodenrollern oder Materialwägen in der Parkschiene
Material	End caps: Plastic PA, glass ball reinforced Position markings: Plastic PET Screw-on set (optional) screw: Steel Screw-on set (optional) plastic anchor: Plastic	Material	Endkappen: Kunststoff PA, glaskugelverstärkt Positionsmarkierungen: Kunststoff PET Anschraubset (optional) Schraube: Stahl Anschraubset (optional) Dübel: Kunststoff
Surface	Screw-on set (optional) screw: Zinc Plated	Oberfläche	Anschraubset (optional) Schraube: verzinkt
Color	End caps: black Position markings: yellow ≈ RAL 1003 Screw-on set (optional) plastic anchor: Yellow	Farbe	Endkappen: schwarz Positionsmarkierungen: gelb ≈ RAL 1003 Anschraubset (optional) Dübel: gelb
Set	2 XL end caps 2 position markings	Set	2 XL Endkappen 2 Positionsmarkierungen
Assembly Set	1 screw-on set (optional): 4 board screws, 4 plastic anchors, 2 position markings	Montageset	1 Anschraubset (optional): 4 Schrauben, 4 Dübel, 2 Positionsmarkierungen
Fastening	Self-adhesive surface on the backside	Befestigung	mit rückseitiger Selbstklebefläche
Pack Quantity	1 set (= 2 pieces)	Liefereinheit	1 Set (= 2 Stück)
Tip	Compatible parking rail high / high (set) for light to medium weights see 02081AHH.0400, Compatible position marking as replacement see 02084S.15	Hinweis	passende Parkschiene hoch / hoch (Set) für leichte bis mittlere Gewichte siehe 02081AHH.0400, passende Positionsmarkierung als Ersatz siehe 02084S.15

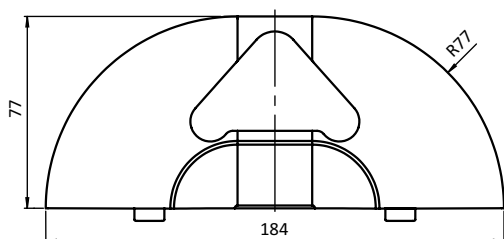

End Cap XL for Parking Rail High / High (Set) Endkappe XL für Parkschiene hoch / hoch (Set)	for Wheel Diameter für Raddurchmesser	Weight [g] Gewicht [g]	Part # Teil-Nr.
	> 100 mm	100.0	02084HHXS01
Screw-on Set End Cap for Parking Rail <i>Anschraubset Endkappe für Parkschiene</i>		47.0	02084R01

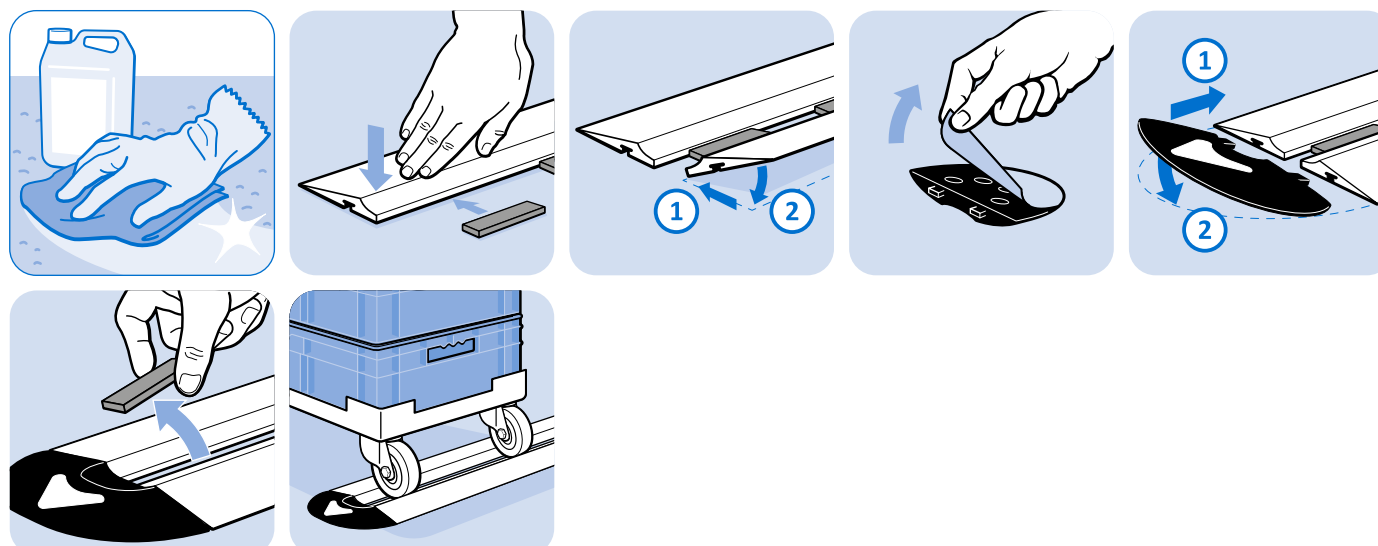

**POSITION MARKING END CAP
 FOR PARKING RAIL**

**POSITIONSMARKIERUNG ENDKAPPE
 FÜR PARKSCHIENE**

Model	Self-adhesive	Ausführung	<i>selbstklebend</i>
Description	To cover the screw holes of end caps for parking rail; Yellow position markings with signal effect to indicate the position of the wheels from floor dollies or material trolleys in the parking rail; Included in the end cap sets, here separately available as replacement	Beschreibung	<i>zum Abdecken der Anschraubbohrungen von Endkappen für Parkschiene; gelbe Positionsmarkierungen mit Signalwirkung zur Anzeige der Position der Räder von Bodenrollern oder Materialwägen in der Parkschiene; enthalten in den Endkappen Sets, hier separat als Ersatz erhältlich</i>
Material	Plastic PET	Material	<i>Kunststoff PET</i>
Color	Yellow ≈ RAL 1003	Farbe	<i>gelb ≈ RAL 1003</i>
Fastening	Self-adhesive surface on the backside	Befestigung	<i>mit rückseitiger Selbstklebefläche</i>
Pack Quantity	1 piece	Liefereinheit	<i>1 Stück</i>

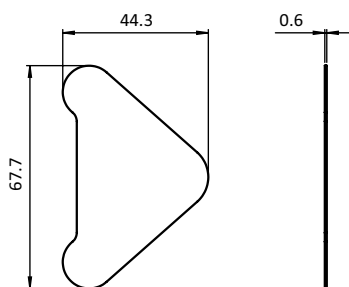

Position Marking End Cap for Parking Rail
 Positionsmarkierung Endkappe für Parkschiene

Weight [g]
 Gewicht [g]

Part #
 Teil-Nr.

2.0

02084S.15



simply
practical

FATH®

COMPONENTS



GUIDING RAILS FIFO (SET) FÜHRUNGSSCHIENEN FIFO (SET)

MODULAR, FLOATING INSTALLATION
BRUCHFESTE EINFÜHRUNGSKAPPEN AUS
ALU-DRUCKGUSS

**BUILD FIFO STATION BASED ON NEEDS WHILE ALSO SAVING SPACE WITH FATH'S GUIDING RAILS FIFO
FIFO-BAHNHOF BEDARFSGERECHT UND PLATZSPAREND KONSTRUIEREN MIT DEN FATH FÜHRUNGS-
SCHIENEN FIFO**

Ingenious Lean product for efficient and structured material provision

- Modular system – scalable when necessary
- Extra wide, break-proof infeed caps
- Profile slot in the guiding rail for inexpensive enclosures
- Floating installation without screwed joints
- Space-saving thanks to one-sided rail guide

- **FLOATING INSTALLATION**
- **EASY SLIDE-IN**

Das smarte Lean-Produkt für die effiziente und strukturierte Materialbereitstellung

- *Modulares System – jederzeit skalierbar*
- *Bruchfeste, extra breite Einführungskappen*
- *Obenliegende Profilnut für kostengünstige Umhausung*
- *Schwimmende Verlegung ohne Verschraubung*
- *Platzsparend durch einseitige Schienenführung*

- **SCHWIMMENDE VERLEGUNG**
- **LEICHTES EINFÄDELN**
- **BRUCHFESTE EINFÜHRUNGSKAPPEN**

INNOVATIVE: EXTRA WIDE INFEED CAPS TO SLIDE IN FLOOR ROLLERS EASILY INNOVATIV: EXTRA BREITE EINFÜHRUNGSKAPPEN FÜR EINFACHES EINFÄDELN DER BODENROLLER

FATH has redesigned the infeed caps to ensure even greater efficiency when handling floor rollers. The extremely wide opening in the infeed caps acts like a funnel and helps facilitate the loading of the FIFO station. Wheels can be effortlessly slid into the rails even when the dollies are completely hidden from view. The infeed caps are mounted at the start and end of each track. This allows operators to implement the FIFO concept (first-in, first-out) perfectly, ensuring an optimized in-house flow of goods.

Yet another invaluable extra: FATH's infeed caps for FIFO stations are aluminum die-casted which makes them unbreakable, unlike conventional plastic caps.

Für noch mehr Effizienz beim Handling der Bodenroller hat FATH die Einführungskappen neu gestaltet. Die besonders breit konstruierte Öffnung der Einführungskappen wirkt wie ein Trichter und erleichtert das Beschicken des FIFO-Bahnhofs enorm. Auch wenn die Rollen unter den Kisten gar nicht zu sehen sind, lassen sie sich mühelos in die Schiene einfädeln. Die Einführungskappen werden am vorderen und hinteren Ende jeder Spur montiert. So lässt sich das FIFO-Prinzip (First-In-First-Out) perfekt umsetzen – für einen optimierten internen Warenfluss.

Noch ein starkes Plus: Die FATH Einführungskappen für den FIFO-Bahnhof werden im Alu-Druckgussverfahren hergestellt und sind im Gegensatz zu herkömmlichen Kunststoffkappen bruchfest.



MODULAR SYSTEM: THE LENGTH AND WIDTH OF THE FIFO STATIONS ARE ADJUSTABLE AND ADAPTABLE MODULARES SYSTEM: LÄNGE UND BREITE DES FIFO-BAHNHOFS FLEXIBEL ANPASSBAR

Thanks to a modular design concept, FIFO stations can be adapted precisely to your requirements and extended at any time. FATH's FIFO Guiding Rails are screwed directly onto the infeed caps with connecting plates. This connection element guarantees stability and determines the track width. The number of tracks can be selected based on requirements.

Individual guiding rails are joined together with a lengthwise connector to achieve the desired track length. FIFO Guiding Rails are available in the standard lengths 1200, 1800 and 2400 mm or in the exact length, you require upon request.

Dank modularer Konzeption kann der FIFO-Bahnhof exakt an die Anforderungen angepasst und jederzeit erweitert werden. Die FIFO Führungsschienen werden mit Verbindungsblechen direkt an den Einführungskappen miteinander verschraubt. Dieses Verbindungselement gewährleistet die Stabilität und gibt die Spurbreite vor. Die Anzahl der Spuren ist bedarfsgerecht wählbar.

Um die gewünschte Spurlänge zu erreichen, werden die einzelnen Führungsschienen mit Hilfe eines Längsverbinders zusammengefügt. Erhältlich sind die Führungsschienen FIFO in den Standardlängen 1200, 1800 und 2400 mm sowie auf Anfrage in der von Ihnen benötigten spezifischen Länge.



RAPID, EASY INSTALLATION WITH NO BOLTING TO THE FLOOR SCHNELLE UND EINFACHE MONTAGE – OHNE VERSCHRAUBUNG MIT DEM BODEN

FATH's FIFO Guiding Rails feature a floating installation design. FIFO stations do not need to be bolted to the floor to ensure they rest securely, protecting warehouse floors. The rails are held by the dead load of the floor rollers. A bolted connection to the floor is available as an option for special requirements; drilling patterns are already integrated into the infeed caps.

Die FATH Führungsschienen FIFO werden schwimmend verlegt. Der FIFO-Bahnhof muss nicht mit dem Boden verschraubt werden, um sicher aufzuliegen, das schont den Hallenboden. Gehalten werden die Schienen vom Eigengewicht der Bodenroller. Für besondere Anforderungen ist eine Verschraubung mit dem Boden optional möglich, die Bohrungen sind bereits in die Einführungskappen integriert.



SPACE-SAVING, ONE-SIDED RAIL GUIDE PLATZSPARENDE, EINSEITIGE SCHIENENFÜHRUNG

One guiding rail per track is sufficient to hold floor rollers firmly in position. You can freely choose which side the floor rollers is guided through. Just three guiding rails are required for three tracks, for example. This reduces costs, saves space and provides additional flexibility.

Für das sichere Platzieren der Bodenroller reicht eine Führungsschiene je Spur aus. Auf welcher Seite der Bodenroller geführt wird, ist frei wählbar. Für drei Spuren werden beispielsweise nur drei Führungsschienen benötigt. Das senkt die Kosten, spart Platz und bietet zusätzliche Flexibilität.



1

2

3

4

5

6

7

8



**UNIQUE ON THE MARKET: RECTANGULAR CONNECTIONS
ENABLE COST-EFFECTIVE ENCLOSURES**
**EINZIGARTIG AM MARKT: RECHTECKIGE VERBINDUNGEN
ERMÖGLICHEN KOSTENGÜNSTIGE UMHAUSUNG**

The 8 mm profile slot incorporated into the FIFO Guiding Rails can be used to effortlessly mount structures with all standard 40 x 40 mm profiles, such as enclosures to indicate tracks. A post for signs is simply positioned at a 90° angle from above and securely inserted into the slot. Machine protection enclosures can also be effortlessly integrated. Thanks to the practical rectangular connections, such housing can be implemented significantly faster and at a far lower cost than with conventional rails.

Durch die in den FIFO Führungsschienen eingearbeitete 8er Profilnut lassen sich Aufbauten mit allen gängigen 40 x 40 mm Profilen problemlos montieren, beispielsweise Umhausungen zur Kennzeichnung der Spuren. Ein Pfosten für die Beschilderung wird einfach von oben im 90° Winkel aufgesetzt und sicher in der Nut verankert. Auch die Integration an Maschinen-Schutzumhausungen ist unkompliziert möglich. Durch die praktische rechtwinklige Verbindung lassen sich solche Vorrichtungen um ein Vielfaches kostengünstiger und deutlich schneller realisieren als bei herkömmlichen Systemen.

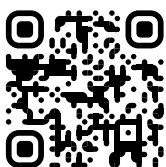

You would like to know more about the FATH Guiding Rails FIFO (Set)?

guiding-rail.fath24.com

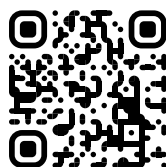

Sie möchten die FATH Führungsschienen FIFO (Set) kennen lernen?

fuehrungsschiene.fath24.de

GUIDING RAIL FIFO (SET)

Model Aluminum, anodized

Description For guiding floor dollies on one side in FIFO stations, with a wheel width of up to 40 mm with 2 slots at the top, bottom and sides; to extend two guiding rails, connect them face to face with connecting strip in the slots; sign posts can be mounted in the slot from above

Material Aluminum

Surface Anodized

Pack Quantity 1 set (= 4 pieces)

Tip For cut: To order, please replace "xxxx" in the part number by the required length in mm, e.g. "0350" for 350 mm or "2000" for 2000 mm
 Compatible connecting strip see 096060S02
 Compatible infeed cap for guiding rail FIFO (set) see 02082CCS01
 Compatible cover profiles see 092080

FÜHRUNGSSCHIENE FIFO (SET)

Ausführung Aluminium, eloxiert

Beschreibung zum einseitigen Führen von Bodenrollern in FIFO-Bahnhöfen, mit einer Radbreite von bis 40 mm; mit jeweils 2 Nuten oben, unten und seitlich; zum Verlängern zwei Führungsschienen stirnseitig mit Streckenverbindern in den Nuten verbinden; Montage von Beschilderungspfeosten in die Nut von oben möglich

Material Aluminium

Oberfläche eloxiert

Liefeinheit 1 Set (= 4 Stück)

Hinweis für Zuschnitt: bitte ersetzen Sie "xxxx" in der Teil-Nr. mit der gewünschten Länge in mm, z.B. "0350" für 350 mm oder "2000" für 2000 mm
 passende Streckenverbinder siehe 096060S02
 passende Einführungskappe für Führungsschiene FIFO (Set) siehe 02082CCS01
 passende Abdeckprofile siehe 092080

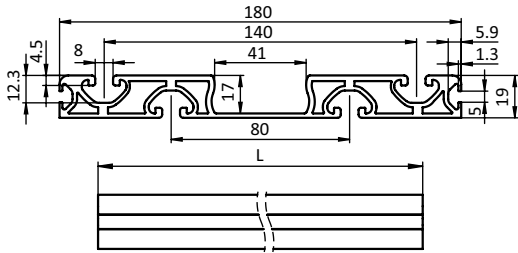

Guiding Rail FIFO (Set) Führungsschiene FIFO (Set)	L [mm]	Weight [g] Gewicht [g]	Profile Profil	Part # Teil-Nr.
	1200.0	3850.0	I	02082P.1200
	1800.0	5774.0	I	02082P.1800
	2400.0	7699.0	I	02082P.2400
			I	02082P.xxxx

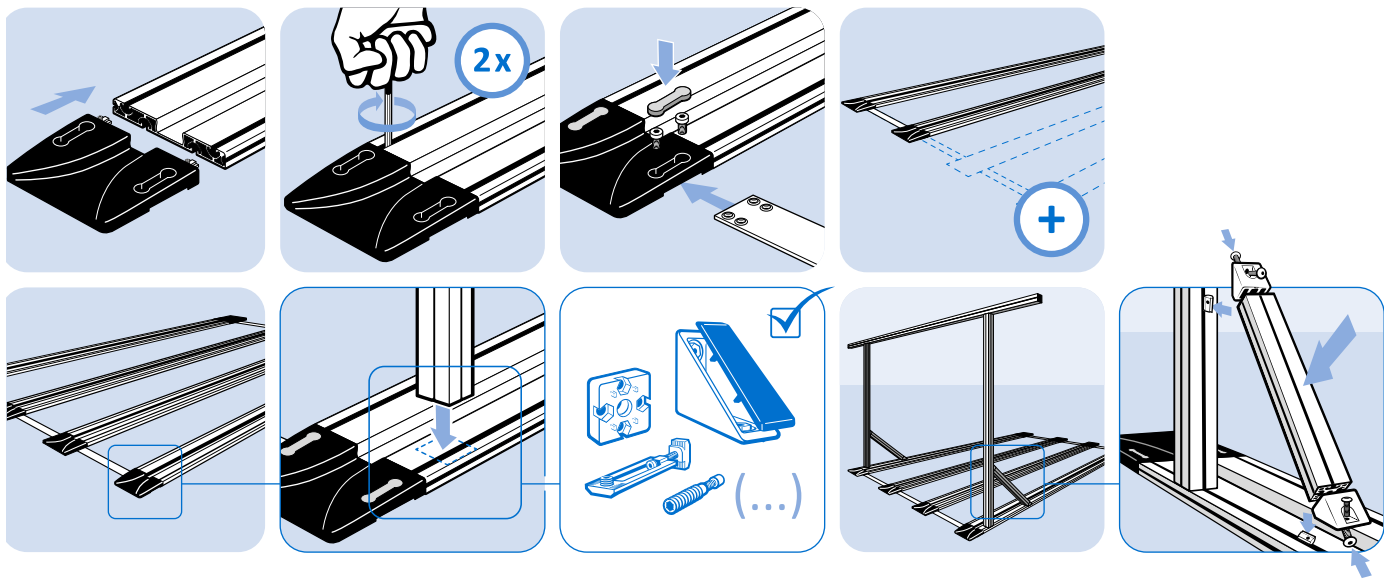

INFEEED CAP FOR GUIDING RAIL FIFO (SET)

EINFÜHRUNGSKAPPE FÜR FÜHRUNGSSCHIENE FIFO (SET)

<p>Model Aluminum die-cast</p> <p>Description For easier loading and unloading of a FIFO stations with floor dollys; Robust design, mounting directly in the slot of guiding rails FIFO with enclosed hexagon socket set screws Yellow screw cover with signal effect to indicate the infeed position for the wheels of floor dollys</p> <p>Material Infeed Caps: Aluminum die-cast Screw Covers: Plastic PC Hexagon socket set screws: Steel</p> <p>Surface Hexagon socket set screws: Zinc plated</p> <p>Color Screw Covers: Yellow ≈ RAL 1003</p> <p>Set 8 infeed caps 16 screw covers 16 hexagon socket set screws ISO 4027 - M6 x 8</p> <p>Fastening From the front, using M6 countersunk screws</p> <p>Pack Quantity 1 set</p> <p>Tip Compatible guiding rail FIFO see 02082P.1200 Compatible connecting element for guiding rail FIFO (set) see 02082D Compatible screw cover infeed cap for guiding rail FIFO see 02082S.15</p>	<p>Ausführung Aluminiumdruckguss</p> <p>Beschreibung zur einfacheren Beschickung und Entladung von FIFO-Bahnhöfen mit Bodenrollern; robuste Ausführung, mit beiliegenden Gewindestiften direkt in der Nut von Führungsschienen FIFO anschraubbar gelbe Schraubenabdeckung mit Signalwirkung zur Anzeige der Einführungsposition für die Räder von Bodenrollern</p> <p>Material Einführungskappen: Aluminiumdruckguss Schraubenabdeckungen: Kunststoff PC Gewindestifte: Stahl</p> <p>Oberfläche Gewindestifte: verzinkt</p> <p>Farbe Schraubenabdeckungen: gelb ≈ RAL 1003</p> <p>Set 8 Einführungskappen 16 Schraubenabdeckungen 16 Gewindestifte ISO 4027 - M6 x 8</p> <p>Befestigung vorderseitig mit Senkschrauben M6</p> <p>Liefereinheit 1 Set</p> <p>Hinweis passende Führungsschiene FIFO siehe 02082P.1200 passendes Verbindungsblech für Führungsschiene FIFO (Set) siehe 02082D passende Schraubenabdeckung Einführungskappe für Führungsschiene FIFO als Ersatz siehe 02082S.15</p>
--	--

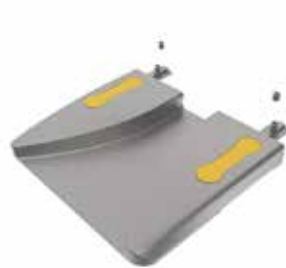
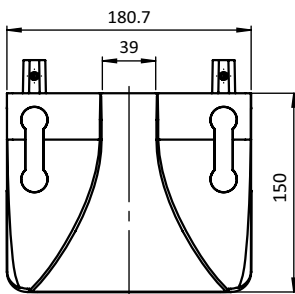

Infeed Cap for Guiding Rail FIFO (Set)
Einführungskappe für Führungsschiene FIFO (Set)

Weight [g]
Gewicht [g]

3.348

Part #
Teil-Nr.

02082CCS01

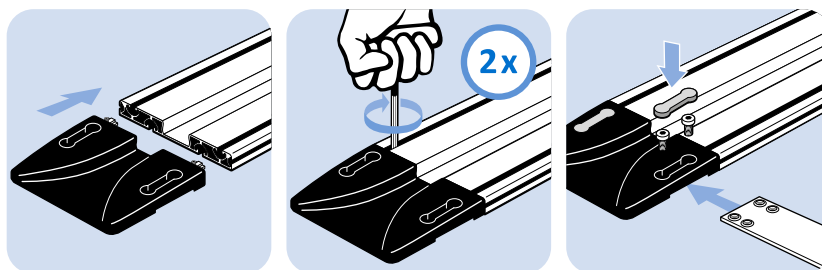

SCREW COVER INFEED CAP FOR GUIDING RAIL FIFO

SCHRAUBENABDECKUNG EINFÜHRUNGSKAPPE FÜR FÜHRUNGSSCHIENE FIFO

Model	Self-adhesive	Ausführung	selbstklebend
Description	To cover the screw holes of infeed caps for guiding rail FIFO; Yellow screw cover with signal effect to indicate the infeed position for the wheels of floor dollies; Included in the infeed cap set, here separately available as replacement	Beschreibung	zum Abdecken der Anschraubbohrung von Einführungskappen für Führungsschiene FIFO; gelbe Schraubenabdeckung mit Signalwirkung zur Anzeige der Einführungsposition für die Räder von Bodenrollern; enthalten im Einführungskappen Set, hier separat als Ersatz erhältlich
Material	Plastic PC	Material	Kunststoff PC
Color	Yellow ≈ RAL 1003	Farbe	gelb ≈ RAL 1003
Fastening	Self-adhesive surface on the backside	Befestigung	mit rückseitiger Selbstklebefläche
Pack Quantity	1 set (= 20 pieces)	Liefereinheit	1 Set (= 20 Stück)

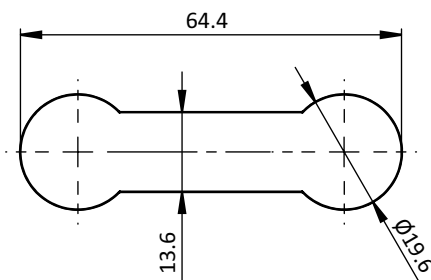

Screw Cover Infeed Cap for Guiding Rail FIFO
 Schraubenabdeckung Einführungskappe für Führungsschiene FIFO

Weight [g]
 Gewicht [g]

Part #
 Teil-Nr.

7.5

02082S.15



CONNECTING ELEMENT FOR GUIDING RAIL FIFO (SET) VERBINDUNGSBLECH FÜR FÜHRUNGSSCHIENE FIFO (SET)

<p>Model Stainless Steel</p> <p>Description For parallel connection of two guiding rails FIFO, as spacer for aligning the track; To be screwed on infeed caps with enclosed screws</p> <p>Material Stainless Steel</p> <p>Set 2 connecting elements 8 screws DIN 7991 (ISO 10642) - M6 x 16</p> <p>Pack Quantity 1 set</p> <p>Tip Compatible guiding rail FIFO see 02082P.1200 Compatible infeed cap for guiding rail FIFO (set) see 02082CCS01</p>	<p>Ausführung Edelstahl</p> <p>Beschreibung zur parallelen Verbindung von zwei Führungsschienen FIFO, als Abstandhalter zum Ausrichten der Spur; mit beiliegenden Schrauben an Einführungskappen anschraubbar</p> <p>Material Edelstahl</p> <p>Set 2 Verbindungsbleche 8 Schrauben DIN 7991 (ISO 10642) - M6 x 16</p> <p>Liefereinheit 1 Set</p> <p>Hinweis passende Führungsschiene FIFO siehe 02082P.1200 passende Einführungskappe für Führungsschiene FIFO (Set) siehe 02082CCS01</p>
---	---

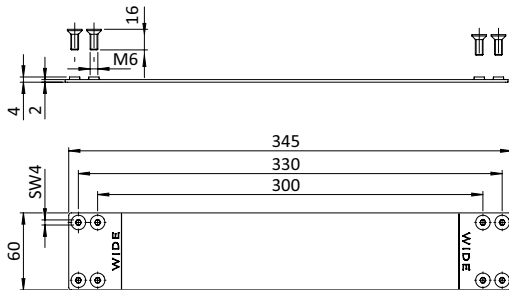

Connecting Element for Guiding Rail FIFO (Set)
Verbindungsblech für Führungsschiene FIFO (Set)

Weight [g]
Gewicht [g]

Part #
Teil-Nr.

692.2

02082D

CONNECTING STRIP 140 I, SLOT 8

STRECKENVERBINDER 140 I, NUT 8

Model	Steel	Ausführung	Stahl
Description	End-to-end connection of two aluminum profiles without machining	Beschreibung	zur stirnseitigen Verbindung von zwei Aluminiumprofilen ohne Profilbearbeitung
Material	Steel, zinc plated	Material	Stahl, verzinkt
Set	1 connecting strip 140 - slot 8 4 screws DIN 914 - M8 x 10	Set	1 Streckenverbinder 140 - Nut 8 4 Schrauben DIN 914 - M8 x 10
Pack Quantity	10 pieces	Lieferinheit	10 Stück

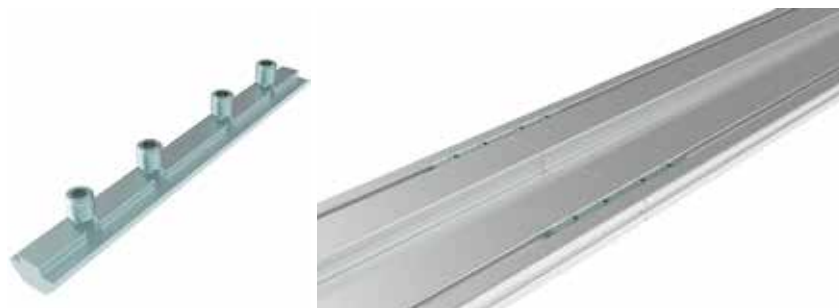
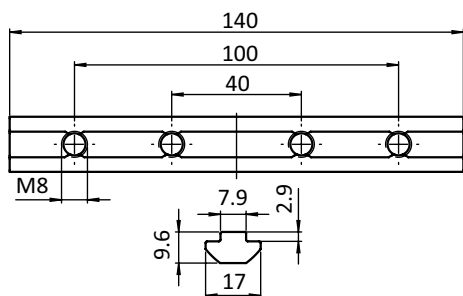

Connecting Strip 140 I, Slot 8 Streckenverbinder 140 I, Nut 8	Slot Nut	L [mm]	Size Größe	Weight [g] Gewicht [g]	Profile Profil	Part # Teil-Nr.
	8	140.0	M8	121.0	I	096060S02

- 1
- 2
- 3
- 4
- 5
- 6
- 7
- 8

COVER PROFILE SLOT 8 - 4.5

ABDECKPROFIL NUT 8 - 4,5

Model	Plastic PP, slot 8	Ausführung	Kunststoff PP, Nut 8
Description	To cover T-Slots with 8 mm width and a 4.5 mm profile web	Beschreibung	zum Abdecken von Nuten mit Breite 8 mm und Steghöhe 4,5 mm
Material	Plastic PP	Material	Kunststoff PP
Color	Black, yellow, gray, natural, alu color	Farbe	schwarz, gelb, grau, natur, alufarbig
Pack Quantity	200 meters (100 pieces at 2 m)	Liefereinheit	200 Meter (100 Stück à 2 m)
Specials	Other colors on request	Extras	weitere Farben auf Anfrage
Tip	Please note: You are ordering in meters!	Hinweis	Bitte beachten: Sie bestellen in Meter!

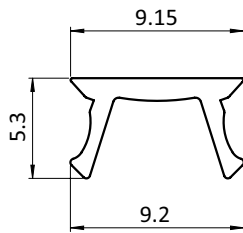

Cover Profile Slot 8 - 4.5
 Abdeckprofil Nut 8 - 4,5

	Color Farbe	Slot Nut	Weight [g/m] Gewicht [g/m]	Profile Profil	Part # Teil-Nr.
	Yellow ≈ RAL 1018 <i>gelb</i>	8	16.0	I	092081
	Gray ≈ RAL 7042 <i>grau</i>	8	16.0	I	092080S02
	Alu color coated <i>alufarbig geprägt</i>	8	16.0	I	092080A
	Black <i>schwarz</i>	8	16.0	I	092080
ESD electrostatical discharging ESD elektrostatisch entladend	Black <i>schwarz</i>	8	16.0	I	092080S03

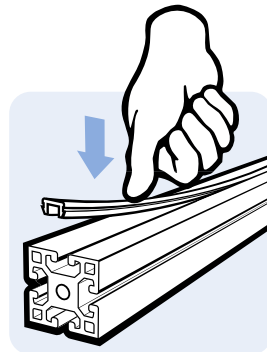

AUTOMATIC CONNECTOR STEEL

AUTOMATIKVERBINDER STAHL

Model	Zinc plated	Ausführung	verzinkt
Description	To connect two aluminum profiles fast and solid, assembly without machining; self-cutting thread	Beschreibung	zur schnellen und stabilen Verbindung von zwei Aluminiumprofilen ohne Profilbearbeitung; selbstschneidendes Gewinde
Material	Steel	Material	Stahl
Surface	Zinc plated	Oberfläche	verzinkt
Pack Quantity	100 pieces	Liefereinheit	100 Stück
Tip	* Compatible cover cap see 099GA081K	Hinweis	* passende Abdeckkappe siehe 099GA081K

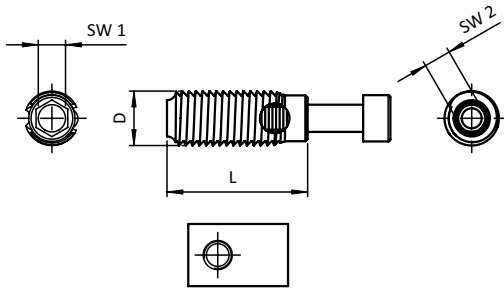

Automatic Connector Steel <i>Automatikverbinder Stahl</i>	Slot Nut	L [mm]	D [mm]	Profile Width Profilbreite	SW1	SW2	Screw Schraube	Weight [g] Gewicht [g]	Profile Profil	Part # Teil-Nr.
Cutting sleeve <i>Schneidhülse</i>	8	31.0	12.0	40		6		13.0	I	*099GS081
With assembly set, incl. screw and T-slot nut <i>inkl. Montageset mit Schraube und Nutstein</i>	8	31.0	12.0	40	5	6	M6 x 40	33.0	I	*099G081

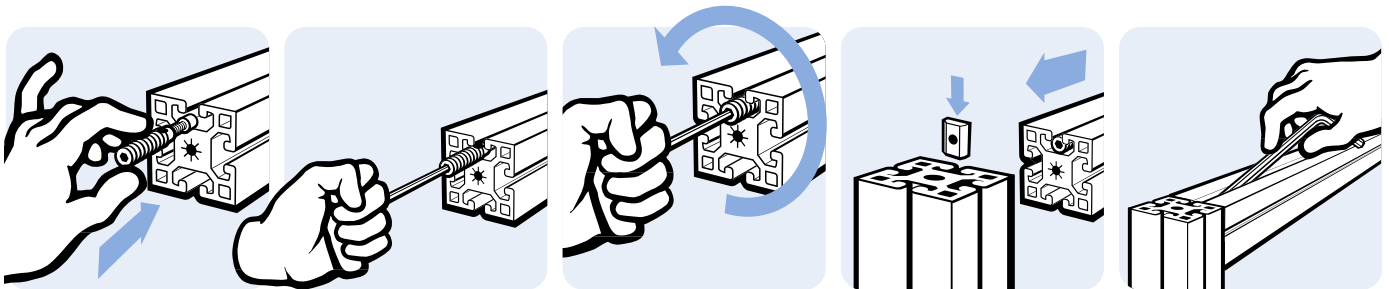

AUTOMATIC DOUBLE CONNECTOR I, SLOT 8 (SET)

AUTOMATIK-DOPPELVERBINDER I, NUT 8 (SET)

Model	Zinc plated / plain	Ausführung	verzinkt / blank
Description	To connect two aluminum profiles fast and solid, assembly without machining; self-cutting thread	Beschreibung	zur schnellen und stabilen Verbindung von zwei Aluminiumprofilen ohne Profilbearbeitung; selbstschneidendes Gewinde
Material	Zinc plated / plain	Material	verzinkt / blank
Surface	Zinc plated	Oberfläche	verzinkt
Pack Quantity	100 pieces	Liefereinheit	100 Stück
Tip	* Compatible cover cap see 099GA081K	Hinweis	* passende Abdeckkappe siehe 099GA081K



Automatic Double Connector I, Slot 8 (Set) <i>Automatik-Doppelverbinder I, Nut 8 (Set)</i>	Slot <i>Nut</i>	L [mm]	D [mm]	Profile Width <i>Profilbreite</i>	Screw <i>Schraube</i>	A [mm]	SW 1	SW 2	Weight [g] <i>Gewicht [g]</i>	Profile <i>Profil</i>	Part # <i>Teil-Nr.</i>
	8	31.0	12.0	40	M6 x 40	26.4	6	5	48.0	I	099G081D40
	8	31.0	12.0	80	M6 x 40	66.4	6	5	62.0	I	099G081D80

PLATE CONNECTOR I ZN 40 (SET)

Model	Zinc die-cast, slot 8
Description	To tee connect two aluminum profiles
Material	Plate Connector: Zinc die-cast Assembly set: Steel
Surface	Plate Connector: Plain / alu color Assembly set: Zinc plated
Assembly Set 1	1 self-tapping screw SF7 x 25, 1 double T-slot nut - Nut 8 - M8, 2 shaft screws M8
Assembly Set 2	2 self-tapping screws SF7 x 25, 1 double T-slot nut - Nut 8 - M8, 2 shaft screws M8
Assembly Set 3	2 self-tapping screws SF7 x 25, 2 double T-slot nut - Nut 8 - M8, 4 shaft screws M8
Pack Quantity	10 pieces

PLATTENVERBINDER I ZN 40 (SET)

Ausführung	Zinkdruckguss, Nut 8
Beschreibung	zum Herstellen einer T-Verbindung zwischen zwei Aluminiumprofilen
Material	Plattenverbinder: Zinkdruckguss Montageset: Stahl
Oberfläche	Plattenverbinder: blank / alufarbig pulverbeschichtet Montageset: verzinkt
Montageset 1	1 Selbstfurchende Schraube SF7 x 25, 1 Doppelnutenstein - Nut 8 - M8, 2 Schaftschrauben M8
Montageset 2	2 Selbstfurchende Schrauben SF7 x 25, 1 Doppelnutenstein - Nut 8 - M8, 2 Schaftschrauben M8
Montageset 3	2 Selbstfurchende Schrauben SF7 x 25, 2 Doppelnutenstein - Nut 8 - M8, 4 Schaftschrauben M8
Liefereinheit	10 Stück

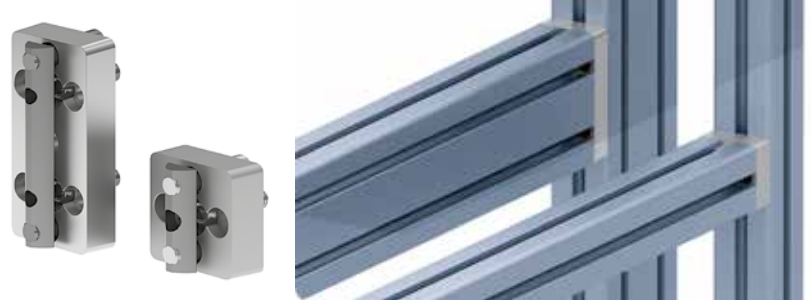
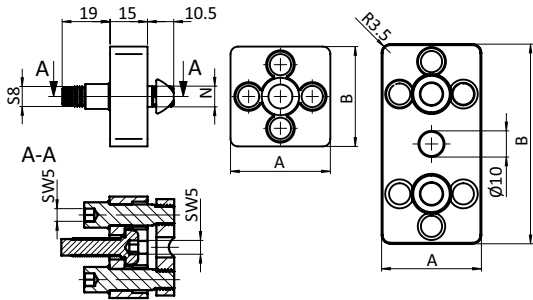

Plate Connector I ZN 40 (Set) Plattenverbinder I ZN 40 (Set)	N	A x B [mm]	Weight [g] Gewicht [g]	Profile Profil	Part # Teil-Nr.
Plain, with assembly set 1 <i>blank, inkl. Montageset 1</i>	8	40 x 40	135.0	I	099E40400808RS01
Plain, with assembly set 2 <i>blank, inkl. Montageset 2</i>	8	40 x 80	242.0	I	099E40800808RS01
Plain, with assembly set 3 <i>blank, inkl. Montageset 3</i>	8	40 x 80	266.0	I	099E40800808RS02
Alu Color, with assembly set 1 <i>alufarbig, inkl. Montageset 1</i>	8	40 x 40	135.0	I	099E40400808AS01
Alu Color, with assembly set 2 <i>alufarbig, inkl. Montageset 2</i>	8	40 x 80	242.0	I	099E40800808AS01
Alu Color, with assembly set 3 <i>alufarbig, inkl. Montageset 3</i>	8	40 x 80	266.0	I	099E40800808AS02



ZINC CONNECTION ANGLE 40 FLAT

ZINKWINKEL 40 FLACH

Model	Zinc die-cast	Ausführung	Zinkdruckguss
Description	To connect two aluminum profiles or panels at right angles; the connection angle can be closed with the cover cap	Beschreibung	zur rechtwinkligen Verbindung von Profilen und Flächenelementen; die offene Seite des Winkels kann durch die Abdeckkappe verschlossen werden
Material	Angle: Zinc die-cast Cover cap: Plastic PA, glass fiber reinforced Assembly set: Steel	Material	Winkel: Zinkdruckguss Abdeckkappe: Kunststoff PA, glasfaserverstärkt Montageset: Stahl
Surface	Angle: Plain / alu color powder coated Assembly set: Zinc plated	Oberfläche	Winkel: blank / alufarbig pulverbeschichtet Montageset: verzinkt
Color	Cover cap: Black, gray	Farbe	Abdeckkappe: schwarz, grau
Assembly Set	1 Cover cap - Plastic PA - black, 2 T-slot nuts - slot 8 - M8, 2 Screws ISO 7380 - M8 x 16	Montageset	1 Abdeckkappe - Kunststoff PA - schwarz, 2 Nutensteine - Nut 8 - M8, 2 Schrauben ISO 7380 - M8 x 16
Pack Quantity	10 pieces	Liefereinheit	10 Stück
Specials	Other surfaces, other colors on request	Extras	weitere Oberflächen, weitere Farben auf Anfrage

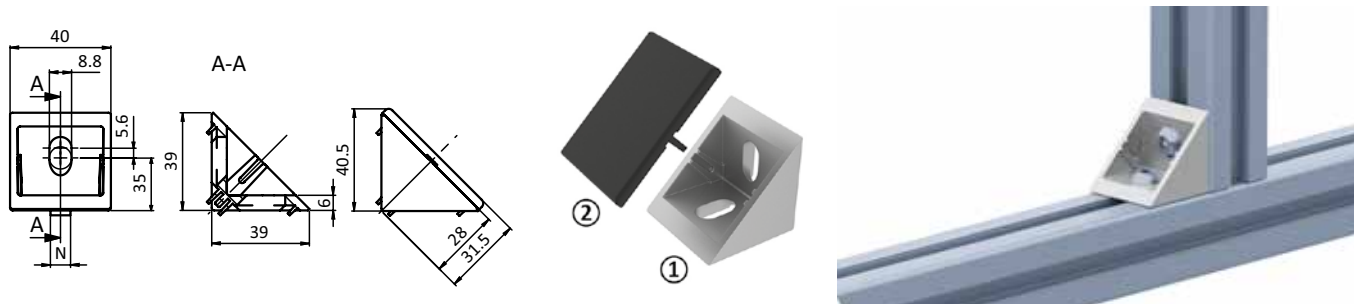
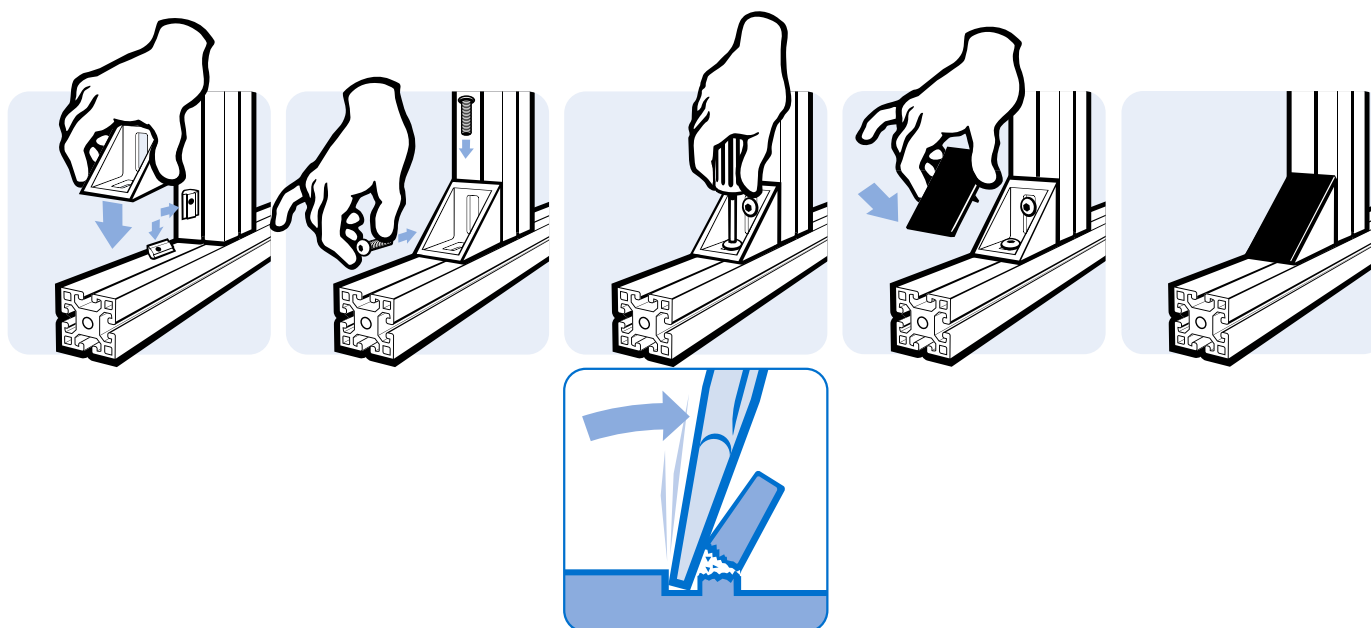

Fig. Abb.	Zinc Connection Angle 40 flat Zinkwinkel 40 flach	N	Weight [g] Gewicht [g]	Profile Profil	Part # Teil-Nr.
①	Plain <i>blank</i>	8	84.0		093W401N08R
①	Alu color <i>alufarbig</i>	8	88.0		093W401N08
②	Cover cap Black <i>Abdeckkappe schwarz</i>		8.0		093WA401
②	Cover cap Gray ≈ RAL 7042 <i>Abdeckkappe grau</i>		8.0		093WA401S01
	Alu color with assembly set <i>alufarbig inkl. Montageset</i>	8	135.5	I	093W401N08S03



ZINC CONNECTION ANGLE 40 / 80 FLAT

ZINKWINKEL 40 / 80 FLACH

Model	Zinc die-cast	Ausführung	Zinkdruckguss
Description	To connect two aluminum profiles or panels at right angles; the connection angle can be closed with the cover cap	Beschreibung	zur rechtwinkligen Verbindung von Profilen und Flächenelementen; die offene Seite des Winkels kann durch die Abdeckkappe verschlossen werden
Material	Angle: Zinc die-cast Cover cap: Plastic PA, glass fiber reinforced Assembly set: Steel	Material	Winkel: Zinkdruckguss Abdeckkappe: Kunststoff PA, glasfaserverstärkt Montageset: Stahl
Surface	Angle: Plain / alu color powder coated Assembly set: Zinc plated	Oberfläche	Winkel: blank / alufarbig pulverbeschichtet Montageset: verzinkt
Color	Cover cap: Black	Farbe	Abdeckkappe: schwarz
Assembly Set	1 Cover cap - Plastic PA - black, 4 T-slot nuts - slot 8 - M8, 4 Screws ISO 7380 - M8 x 16	Montageset	1 Abdeckkappe - Kunststoff PA - schwarz, 4 Nutensteine - Nut 8 - M8, 4 Schrauben ISO 7380 - M8 x 16
Pack Quantity	10 pieces	Liefereinheit	10 Stück
Specials	Other surfaces, other colors on request	Extras	weitere Oberflächen, weitere Farben auf Anfrage

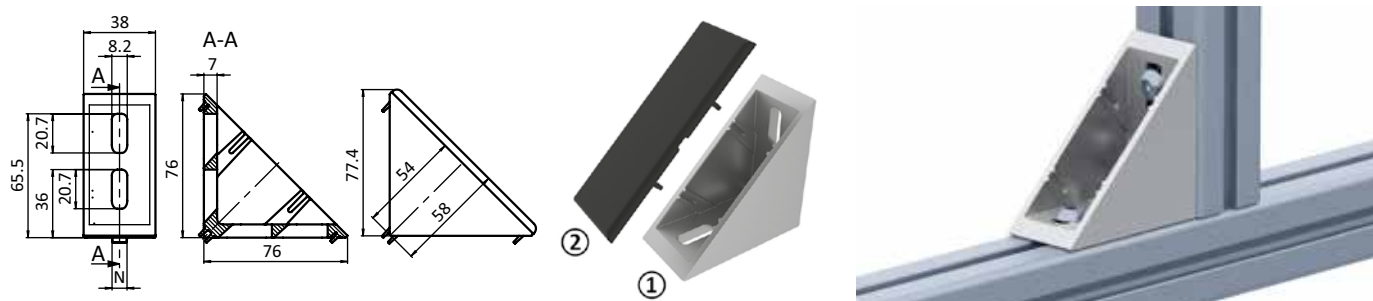
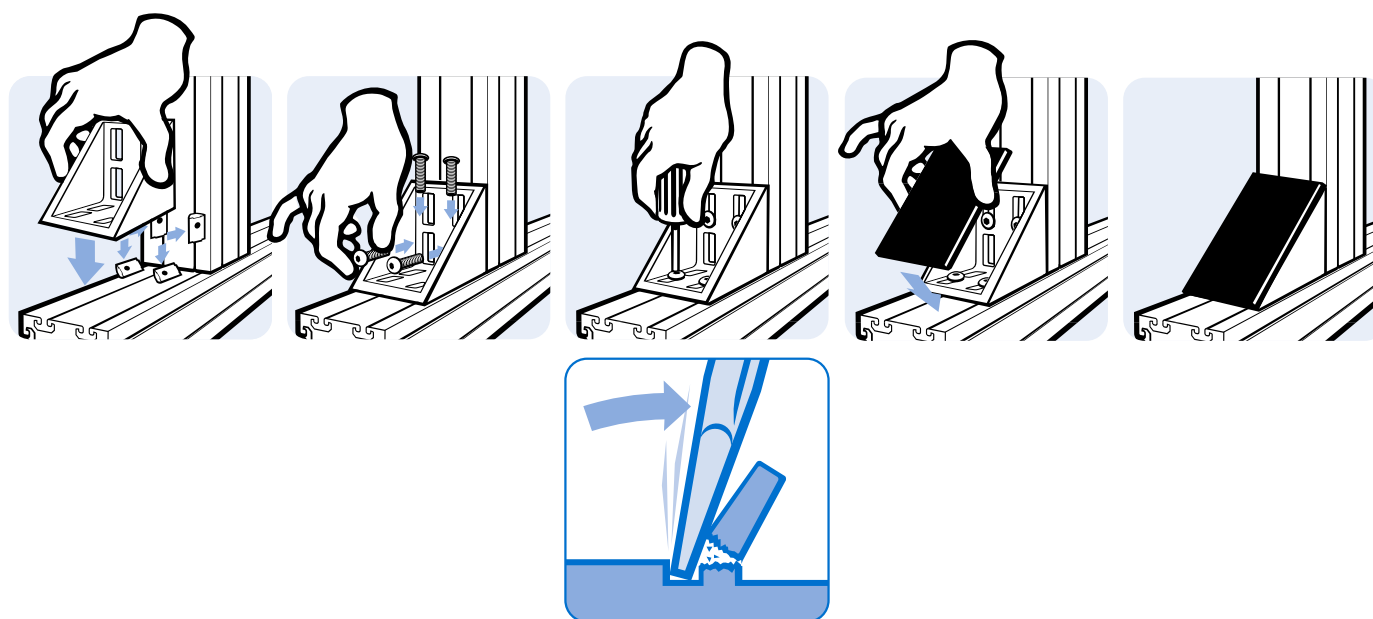

Fig. Abb.	Zinc Connection Angle 40 / 80 flat Zinkwinkel 40 / 80 flach	N	Weight [g] Gewicht [g]	Profile Profil	Part # Teil-Nr.
①	Plain <i>blank</i>	8	269.0		093W802N08R
①	Alu color <i>alufarbig</i>	8	270.0		093W802N08
②	Cover cap <i>Abdeckkappe</i>		17.2		093WA802
	incl. assembly set <i>inkl. Montageset</i>	8	361.0	I	093W802N08S02



MILLING CONNECTOR I, SLOT 8

FRÄSVERBINDER I, NUT 8

Model	Steel, slot 8	Ausführung	Stahl, Nut 8
Description	To connect two aluminum profiles fast and solid; assembly without machining	Beschreibung	zur schnellen und stabilen Verbindung von zwei Aluminiumprofilen; Montage ohne Profilbearbeitung
Material	Steel	Material	Stahl
Set	1 milling connector, 1 screw DIN 912 - M5 x 18, 1 hammer nut	Set	1 Fräsverbinder, 1 Schraube DIN 912 - M5 x 18, 1 Hammermutter
Pack Quantity	10 pieces	Liefereinheit	10 Stück

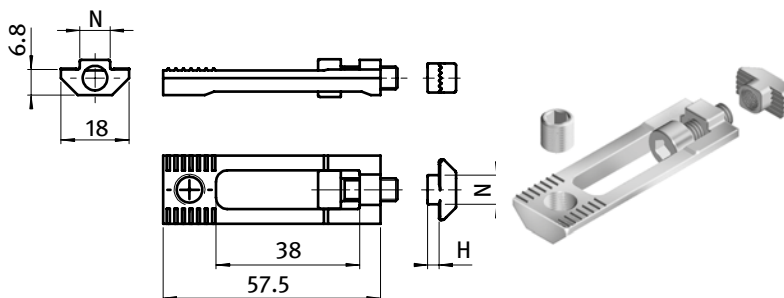

Milling Connector I, Slot 8 Fräsverbinder I, Nut 8	H [mm]	N	Weight [g] Gewicht [g]	Profile Profil	Part # Teil-Nr.
Set	3.0	8	37.3	I	099D0840M0530

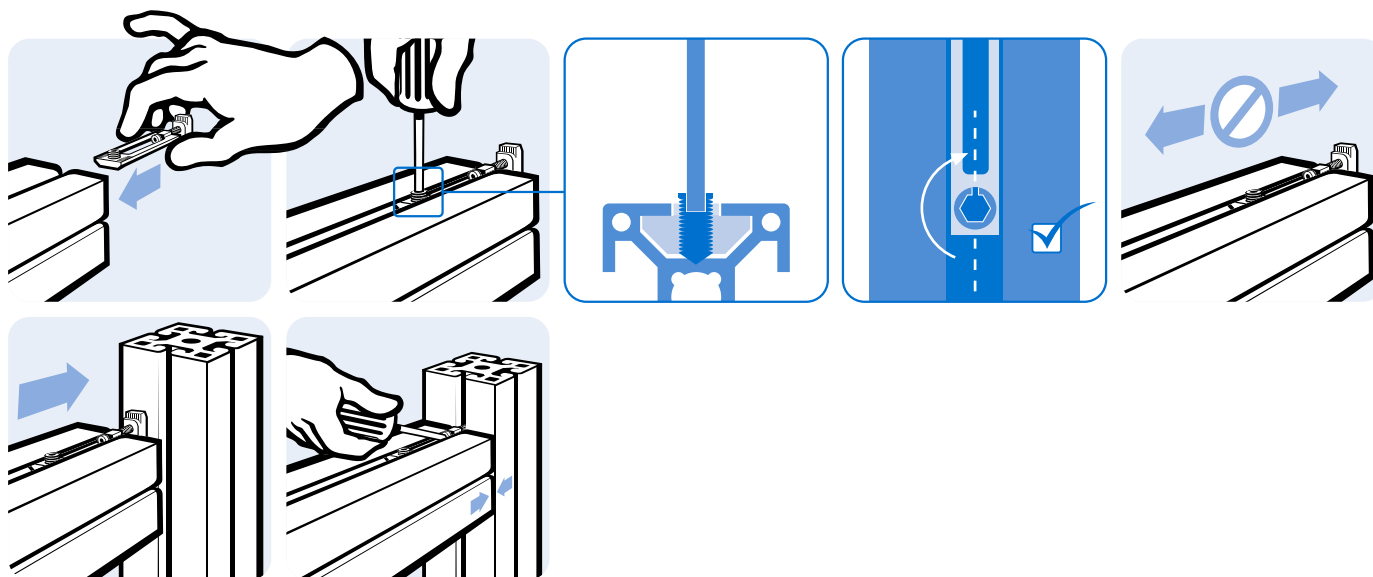

ROLL-IN T-SLOT NUT 13.5 X 7.2 MM WITH SPRING LOADED BALL

NUTENSTEIN 13,5 X 7,2 MM, EINSCHWENKBAR MIT FEDERKUGEL

Model	Slot 8, self-aligning with spring loaded ball, # b steel / stainless steel	Ausführung	Nut 8, mit Führungssteg und Federkugel, Stahl / Edelstahl
Description	Self-aligning roll-in T-slot nut with spring loaded ball	Beschreibung	einschwenkbarer Nutenstein mit Führungssteg und Federkugel
Material	T-slot nut: Zinc plated steel / stainless steel SS304 / SS303 Rod: Steel, plain, without thread Ball: Stainless steel	Material	Nutenstein: Stahl, verzinkt / Edelstahl 1.4301 / 1.4305 Profil: Stahl, blank, ohne Gewinde Kugel: Edelstahl
Pack Quantity	100 pieces	Liefereinheit	100 Stück
Specials	ESD electrostatical discharging, different lengths with multiple threads in different sizes available on request	Extras	ESD elektrostatisch entladend, verschiedene Längen mit mehreren Gewinden in unterschiedlichen Größen auf Anfrage

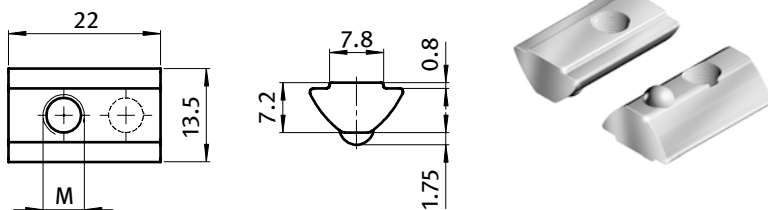

Roll-in T-slot Nut 13.5 x 7.2 mm with Spring Loaded Ball
Nutenstein 13,5 x 7,2 mm, einschwenkbar mit Federkugel

	Size Größe	Weight [g] Gewicht [g]	Profile Profil	Part # Teil-Nr.
Steel <i>Stahl</i>	M3	10.9	I	096023
	M4	10.8	I	096024
	M5	10.5	I	096025
	M6	9.9	I	096026
	M8	9.0	I	096028





ADAPTER PLATE D28

ADAPTERPLATTE D28

Model	For tubular frame profiles	Ausführung	für Rundrohrprofile
Description	To connect tubular frame profiles with slot 8 or 10 aluminum profiles	Beschreibung	zur Verbindung von Rundrohrprofilen mit Aluminiumprofilen Nut 8 oder Nut 10
Material	Adapter plates: Aluminum die-cast Centering piece: Zinc die-cast	Material	Adapterplatte: Aluminiumdruckguss Nutfixierung: Zinkdruckguss
Surface	Plain	Oberfläche	blank
Set	1 adapter plate, 2 locating pins for slot 8 and 10	Set	1 Adapterplatte, 2 Nutfixierungen für Nut 8 und Nut 10
Fastening	with pan-head-screw ISO 7380 - M8	Befestigung	mit Linsenkopfschrauben ISO 7380 - M8
Pack Quantity	10 pieces	Liefereinheit	10 Stück
Tip	Compatible connector see 099RV2890LS01, 099RV28KS01, 099RV2845S01 - 099RV2890QS01 * Cut bush for the reduction of the $\varnothing 10.2$ mm core hole to thread size M8 see 09308801	Hinweis	passender Verbinder siehe 099RV2890LS01, 099RV28KS01, 099RV2845S01 - 099RV2890QS01 * Schneidhülse zur Reduzierung des Kernlochs $\varnothing 10,2$ mm auf Gewindegröße M8 siehe 09308801

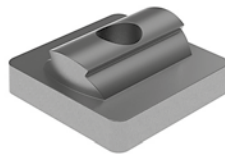
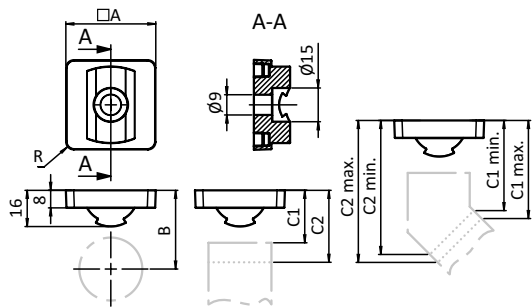

Adapter Plate D28 Adapterplatte D28	N	R [mm]	A [mm]	Weight [g] Gewicht [g]	Part # Teil-Nr.
ESD electrostatical discharging ESD elektrostatisch entladend	8 / 10	4.0	40.0	29.0	099RVAP40S01
	8 / 10	3.0	45.0	33.0	*099RVAP45S01

T-CONNECTOR PLATE D28

T-VERBINDERPLATTE D28

<p>Model For tubular frame profiles</p> <p>Description To connect a tubular frame profile with $\varnothing 28$ mm outer diameter with an aluminum profile at right angles; screw connection to the core hole of the $\varnothing 28$ mm profile or to the threaded sleeve for D28 M8 for $\varnothing 28$ mm tubular profiles</p> <p>Material Steel</p> <p>Surface Zinc plated</p> <p>Fastening With countersunk screws 1x M8 and 2x M6</p> <p>Pack Quantity 10 pieces</p> <p>Tip Compatible threaded sleeve D28 M8 see 099RV28AS02</p>	<p>Ausführung für Rundrohrprofile</p> <p>Beschreibung zur rechtwinkligen Verbindung von einem Rundrohrprofil mit Aussendurchmesser $\varnothing 28$ mm mit einem Aluminiumprofil; Verschraubung im Kernloch M8 des Rundrohrprofils $\varnothing 28$ mm, oder in der Gewindehülse D28 M8 für Rundrohrprofile $\varnothing 28$ mm</p> <p>Material Stahl</p> <p>Oberfläche verzinkt</p> <p>Befestigung mit Senkkopfschrauben 1x M8 und 2x M6</p> <p>Liefereinheit 10 Stück</p> <p>Hinweis passende Gewindehülse D28 M8 siehe 099RV28AS02</p>
--	---

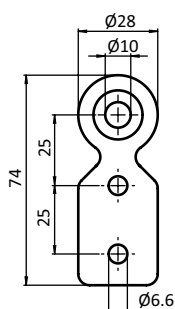

T-connector Plate D28
 T-Verbinderplatte D28

Weight [g]
 Gewicht [g]

Part #
 Teil-Nr.

52.3

093VAD28V



ROLLER TRACK XST R28

ROLLENSCHIENE XST R28

Model	Assembled ready for use	Ausführung	fertig montiert
Description	Economical, resilient and smooth running roller track XST R28, without flange as lateral guiding	Beschreibung	preiswerte, belastbare und lauffruhige Rollenschiene XST R28, ohne Spurkranz als seitliche Führung
Material	Roller track profile XST: Steel Standard roller: Plastic PP ESD electrostatically discharging roller: Plastic PP, electrostatically discharging Axle: Steel	Material	Rollenschiene-Profil XST: Stahl Standard Rolle: Kunststoff PP ESD elektrostatisch entladende Rolle: Kunststoff PP, elektrostatisch entladend Achse: Stahl
Color	Black, gray	Farbe	schwarz, grau
Pack Quantity	12 piece at 2000 mm	Liefereinheit	12 Stück à 2000 mm
Specials	Other colors on request	Extras	weitere Farben auf Anfrage

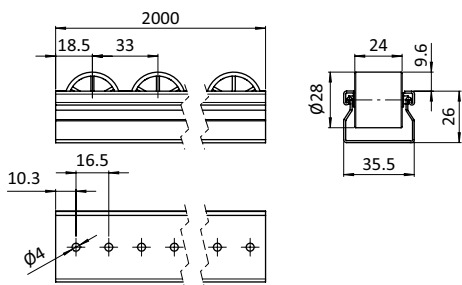

Roller Track XST R28 <i>Rollenschiene XST R28</i>	ESD	Color of Roller <i>Farbe Rolle</i>	Weight [g/m] <i>Gewicht [g/m]</i>	Part # <i>Teil-Nr.</i>
		Gray ≈ RAL 7042 <i>grau</i>	823.0	6XPR2872.2000
	ESD	Black <i>schwarz</i>	886.0	6XPR2891ESD.2000

ROLLER TRACK XST R28 MIT SPURKRANZ

ROLLENSCHIENE XST R28 WITH FLANGE

Model	Assembled ready for use	Ausführung	fertig montiert
Description	Economical, resilient and smooth running roller track XST R28, with flange as lateral guiding	Beschreibung	preiswerte, belastbare und laufruhige Rollenschiene XST R28, mit Spurkranz als seitliche Führung
Material	Roller track profile XST: Steel Standard roller: Plastic PP ESD electrostatically discharging roller: Plastic PP, electrostatically discharging Axle: Steel	Material	Rollenschiene-Profil XST: Stahl Standard Rolle: Kunststoff PP ESD elektrostatisch entladende Rolle: Kunststoff PP, elektrostatisch entladend Achse: Stahl
Color	Black, gray	Farbe	schwarz, grau
Pack Quantity	1 piece at 2000 mm; Cut min. 100 mm - max. 4500 mm	Liefeinheit	1 Stück à 2000 mm; Zuschnitt min. 100 mm - max. 4500 mm
Specials	Other colors on request	Extras	weitere Farben auf Anfrage

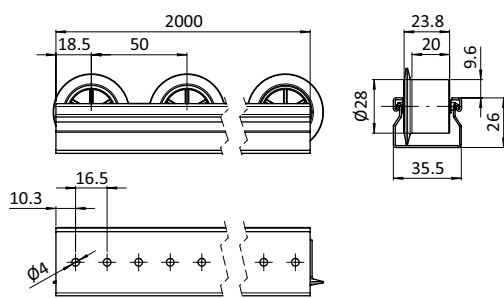

Roller Track XST R28 mit Spurkranz Rollenschiene XST R28 with Flange	ESD	Color of Roller Farbe Rolle	Weight [g/m] Gewicht [g/m]	Part # Teil-Nr.
		Gray ≈ RAL 7042 grau	775.0	6XPR28F72.2000
	ESD	Black schwarz	815.0	6XPR28F91ESD.2000



ROLLER TRACK XST H26

ROLLENSCHIENE XST H26

Model	Assembled ready for use	Ausführung	fertig montiert
Description	Economical, resilient and smooth running roller track XST H26	Beschreibung	preiswerte, belastbare und laufruhige Rollenschiene XST H26
Material	Roller track profile XST: Steel Standard roller: Plastic PP ESD electrostatically discharging roller: Plastic PP, electrostatically discharging Axle: Steel	Material	Rollenschiene-Profil XST: Stahl Standard Rolle: Kunststoff PP ESD elektrostatisch entladende Rolle: Kunststoff PP, elektrostatisch entladend Achse: Stahl
Color	Black, gray	Farbe	schwarz, grau
Pack Quantity	12 piece at 2000 mm	Liefereinheit	12 Stück à 2000 mm
Specials	Other colors on request	Extras	weitere Farben auf Anfrage

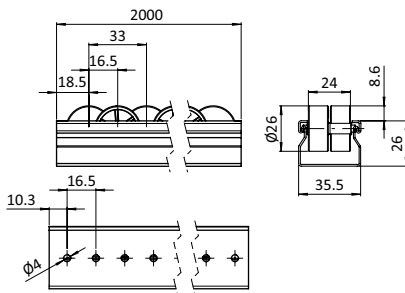

Roller Track XST H26 Rollenschiene XST H26	ESD	Color of Roller Farbe Rolle	Weight [g/m] Gewicht [g/m]	Part # Teil-Nr.
		Gray ≈ RAL 7042 grau	834.0	6XPH2672.2000
	ESD	Black schwarz	882.0	6XPH2691ESD.2000

HOLDING BRACKET ST D28

EINHÄNGEHALTER ST D28

Model	For roller tracks ST	Ausführung	für Rollenschienen ST
Description	To mount roller tracks ST and guiding rails ST central to tubular frame profiles with Ø 28 mm outer diameter, preventing inserts from slipping out	Beschreibung	zum Einhängen von Rollenschienen ST und Führungsschienen ST zentral in ein Rundrohrprofil mit Außendurchmesser Ø 28 mm, verhindert das Herausrutschen von Einsätzen
Material	Steel	Material	Stahl
Surface	Zinc plated	Oberfläche	verzinkt
Fastening	With 3 self-drilling screws DIN 7504 Form N - 3.9 x 16	Befestigung	mit 3 Bohrschrauben DIN 7504 Form N - 3,9 x 16
Pack Quantity	10 pieces	Lieferereinheit	10 Stück
Specials	Other surfaces, other colors on request	Extras	weitere Oberflächen, weitere Farben auf Anfrage



Fig.1 Abb.1	Holding Bracket ST D28 Einhängehalter ST D28	Weight [g] Gewicht [g]	Part # Teil-Nr.
①	Without end stop <i>ohne Anschlag</i>	135.8	062MHD28M
②	With end stop <i>mit Anschlag</i>	156.1	062MHSD28M

VARIABLE HOLDING BRACKET ST D28

VARIABLE HALTER ST D28

Model	For roller tracks ST	Ausführung	für Rollenschienen ST
Description	Transition between roller tracks with varying inclination, to mount roller tracks ST and guiding rails ST central, at different angles, to tubular frame profiles with Ø 28 mm outer diameter, preventing inserts from slipping out	Beschreibung	für Rollenschienenübergang mit wechselndem Gefälle, zum Einhängen von Rollenschienen ST und Führungsschienen St zentral mit variablem Neigungswinkel in ein Rundrohrprofil mit Außendurchmesser Ø 28 mm, verhindert das Herausrutschen von Einsätzen
Material	Steel	Material	Stahl
Surface	Zinc plated	Oberfläche	verzinkt
Fastening	With 3 or 4 self-drilling screws DIN 7504 Form N - 3,9 x 16	Befestigung	mit 3 oder 4 Bohrschrauben DIN 7504 Form N - 3,9 x 16
Pack Quantity	10 pieces	Liefereinheit	10 Stück
Specials	Other surfaces, other colors on request	Extras	weitere Oberflächen, weitere Farben auf Anfrage

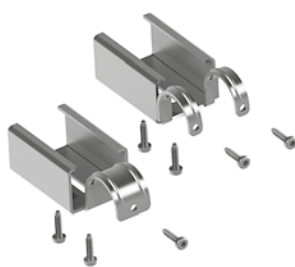
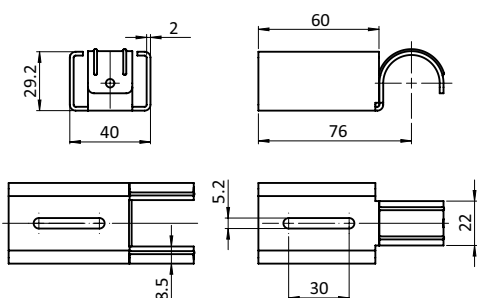
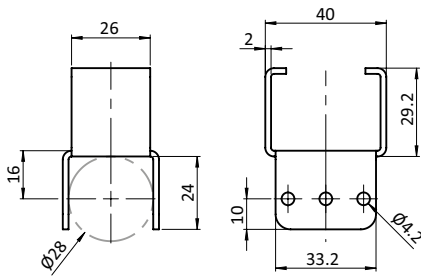

Fig.1 Abb.1	Variable Holding Bracket ST D28 Variabler Halter ST D28	Weight [g] Gewicht [g]	Part # Teil-Nr.
①	Typ M	106.0	062MYMD28M
②	Typ F	103.0	062MYFD28M

MOUNTING BRACKET ST D28

MONTAGEHALTER ST D28

Model	For roller tracks ST	Ausführung	für Rollenschienen ST
Description	To mount and support an roller track ST or a guiding rail ST central on a crossing tubular frame profile with \varnothing 28 mm outer diameter	Beschreibung	zum Einhängen und Abstützen einer kreuzenden Rollenschiene ST oder einer Führungsschiene ST zentral über einem Rundrohrprofil mit Außendurchmesser \varnothing 28 mm
Material	Steel	Material	Stahl
Surface	Zinc plated	Oberfläche	verzinkt
Fastening	with 2 till 6 self-drilling screws DIN 7504 Form N - 3,9 x 16	Befestigung	mit 2 bis 6 Bohrschrauben DIN 7504 Form N - 3,9 x 16
Pack Quantity	10 pieces	Lieferinheit	10 Stück
Specials	Other surfaces, other colors on request	Extras	weitere Oberflächen, weitere Farben auf Anfrage



Mounting Bracket ST D28
 Montagehalter ST D28

Weight [g]
 Gewicht [g]

64.0

Part #
 Teil-Nr.

062MMD28M

02		0203WRA531	86	02013S6701	36	02021E37105TM55	63
0203HF09015	85	0203WRA555	86	02013S6715	36	02021E37105TM63	63
0203HF09031	85	0203WRA563	86	02013S6731	36	02021E37105TM91	63
0203HF09055	85	0209SM01	116	02013S6755	36	02021E37105TM93	63
0203HF09063	85	0209SM02	117	02013S6763	36	02021E50105LA15	58
0203HI05015	83	0209SM03	118	02013S6775	36	02021E50105LA31	58
0203HI05031	83	0209SM04	119	02013S6791	36	02021E50105LA55	58
0203HI05055	83	0209SM05	120	02013S6793	36	02021E50105LA63	58
0203HI05063	83	0209SP01	114	02013S8501	37	02021E50105LA91	58
0203HI07515	84	0209SP02	115	02013S8515	37	02021E50105LA93	58
0203HI07531	84	0209SW01	121	02013S8531	37	02021E50105LM15	60
0203HI07555	84	02011A1/3A15	19	02013S8555	37	02021E50105LM31	60
0203HI07563	84	02011A1/3A31	19	02013S8563	37	02021E50105LM55	60
0203HLO5015	81	02011A1/3A55	19	02013S8575	37	02021E50105LM63	60
0203HLO5031	81	02011A1/3A63	19	02013S8591	37	02021E50105LM91	60
0203HLO5055	81	02011A1/3H15	16	02013S8593	37	02021E50105LM93	60
0203HLO5063	81	02011A1/3H31	16	02013S13501	38	02021E50105TA15	62
0203HLO7515	82	02011A1/3H55	16	02013S13515	38	02021E50105TA31	62
0203HLO7531	82	02011A1/3H63	16	02013S13531	38	02021E50105TA55	62
0203HLO7555	82	02011A1/3M15	22	02013S13555	38	02021E50105TA63	62
0203HLO7563	82	02011A1/3M31	22	02013S13563	38	02021E50105TA91	62
0203HT05015	79	02011A1/3M55	22	02013S13575	38	02021E50105TA93	62
0203HT05031	79	02011A1/3M63	22	02013S13591	38	02021E50105TM15	64
0203HT05055	79	02011A4PA15	20	02013S13593	38	02021E50105TM31	64
0203HT05063	79	02011A4PA31	20	02013T6701	33	02021E50105TM55	64
0203HT07515	80	02011A4PA55	20	02013T6715	33	02021E50105TM63	64
0203HT07531	80	02011A4PA63	20	02013T6731	33	02021E50105TM91	64
0203HT07555	80	02011A4PH15	17	02013T6755	33	02021E50105TM93	64
0203HT07563	80	02011A4PH31	17	02013T6763	33	02021E60100SA15	65
0203SM01	98	02011A4PH55	17	02013T6775	33	02021E60100SA31	65
0203SM02	99	02011A4PH63	17	02013T6791	33	02021E60100SA55	65
0203SM03	100	02011A4PM15	23	02013T6793	33	02021E60100SA63	65
0203SM04	101	02011A4PM31	23	02013T8501	34	02021E60100SA93	65
0203SM05	102	02011A4PM55	23	02013T8515	34	02021E60100SM15	66
0203SM06	103	02011A4PM63	23	02013T8531	34	02021E60100SM31	66
0203SM07	104	02011A5LA15	18	02013T8555	34	02021E60100SM55	66
0203SM08	105	02011A5LA31	18	02013T8563	34	02021E60100SM63	66
0203SP01	93	02011A5LA55	18	02013T8575	34	02021E60100SM93	66
0203SP02	94	02011A5LA63	18	02013T8591	34	02021E60200SA15	65
0203SP03	95	02011A5LH15	15	02013T8593	34	02021E60200SA31	65
0203SP04	96	02011A5LH31	15	02013T13501	35	02021E60200SA55	65
0203SP05	97	02011A5LH55	15	02013T13515	35	02021E60200SA63	65
0203SW01	106	02011A5LH63	15	02013T13531	35	02021E60200SA93	65
0203SW02	107	02011A5LM15	21	02013T13555	35	02021E60200SM15	66
0203SW03	113	02011A5LM31	21	02013T13563	35	02021E60200SM31	66
0203T05015	73	02011A5LM55	21	02013T13575	35	02021E60200SM55	66
0203T05031	73	02011A5LM63	21	02013T13591	35	02021E60200SM63	66
0203T05055	73		24	02013T13593	35	02021E60200SM93	66
0203T05063	73	02011E02	25	02021E37105LA15	57	02021E60300SA15	65
0203T07515	74	02011E03	26	02021E37105LA31	57	02021E60300SA31	65
0203T07531	74	02011E04	27	02021E37105LA55	57	02021E60300SA55	65
0203T07555	74	02011E05	28	02021E37105LA63	57	02021E60300SA63	65
0203T07563	74	02012A1/4A	41	02021E37105LA91	57	02021E60300SA93	65
0203T0501591	73	02012A1/4H	40	02021E37105LA93	57	02021E60300SM15	66
0203T0503193	73	02012A1/4M	42	02021E37105LM15	59	02021E60300SM31	66
0203WRA1/215	89	02012A5A	41	02021E37105LM31	59	02021E60300SM55	66
0203WRA1/231	89	02012A5H	40	02021E37105LM55	59	02021E60300SM63	66
0203WRA1/255	89	02012A5M	42	02021E37105LM63	59	02021E60300SM93	66
0203WRA1/263	89	02012A6A	41	02021E37105LM91	59	02021H20075A01	47
0203WRA1/315	87	02012A6H	40	02021E37105LM93	59	02021H20075M01	52
0203WRA1/331	87	02012A6M	42	02021E37105TA15	61	02021H20100A01	47
0203WRA1/355	87	02012A7A	41	02021E37105TA31	61	02021H20100M01	52
0203WRA1/363	87	02012A7H	40	02021E37105TA55	61	02021H20150A01	47
0203WRA415	88	02012A7M	42	02021E37105TA63	61	02021H20150M01	52
0203WRA431	88	02012ASA	39	02021E37105TA91	61	02021H27075A01	48
0203WRA455	88	02012ECA	41	02021E37105TA93	61	02021H27075M01	53
0203WRA463	88	02012ECH	40	02021E37105TM15	63	02021H27100A01	48
0203WRA515	86	02012ECM	42	02021E37105TM31	63	02021H27100M01	53

02021H27150A01	48	093W401N08S03	180
02021H27150M01	53	093W802N08	181
02021H38075A01	49	093W802N08R	181
02021H38075M01	54	093W802N08S02	181
02021H38100A01	49	093WA401	180
02021H38100M01	54	093WA401S01	180
02021H38150A01	49	093WA802	181
02021H38150M01	54	096023	183
02021H47100A01	50	096024	183
02021H47100M01	55	096025	183
02021H47150A01	50	096026	183
02021H47150M01	55	096028	183
02021H67100A01	51	096060S02	175
02021H67100M01	56	099D0840M0530	182
02021H67200A01	51	099E40400808AS01	179
02021H67200M01	56	099E40400808RS01	179
02065WA315	138	099E40800808AS01	179
02065WA331	138	099E40800808AS02	179
02065WA355	138	099E40800808RS01	179
02065WA375	138	099E40800808RS02	179
02065WA415	137	*099G081	177
02065WA431	137	099G081D40	178
02065WA455	137	099G081D80	178
02065WA475	137	*099GS081	177
02081AHH.0400	159	099RVAP40S01	184
02081AHH.0800	159	*099RVAP45S01	184
02081AHH.1200	159		
02081AHH.2400	159	6M	
02081ALH.0400	158	6MHHM75100D40	142
02081ALH.0800	158	6MHHM75100S40	140
02081ALH.1200	158	6MHHM75100S40IT	144
02081ALH.2400	158		
02081ALL.0400	157	6X	
02081ALL.0800	157	6XPH2672.2000	188
02081ALL.1200	157	6XPH2691ESD.2000	188
02081ALL.2400	157	6XPR28F72.2000	187
02082CCS01	172	6XPR28F91ESD.2000	187
02082D	174	6XPR2872.2000	186
02082P.1200	171	6XPR2891ESD.2000	186
02082P.1800	171		
02082P.2400	171		
02082P.xxxx	171		
02082S.15	173		
02084HHS01	162		
02084HHXLS01	164		
02084LHS01	161		
02084LHXL01	163		
02084LLS01	160		
02084R01	162		
02084R01	164		
02084S.15	165		
06			
062MHD28M	189		
062MHSD28M	189		
062MMD28M	191		
062MYFD28M	190		
062MYMD28M	190		
09			
092080	176		
092080A	176		
092080S02	176		
092080S03	176		
092081	176		
093VAD28V	185		
093W401N08	180		
093W401N08R	180		

2			
2-sides Open Magnetic Label Envelope 37 - 1.5"	59	Magnetic Label Holder 27 - 1.06"	53
2-sides Open Magnetic Label Envelope 50 - 2"	60	Magnetic Label Holder 38 - 1.5"	54
2-sides Open Self-adhesive Label Envelope 37 - 1.5"	57	Magnetic Label Holder 47 - 1.85"	55
2-sides Open Self-adhesive Label Envelope 50 - 2"	58	Magnetic Label Holder 67 - 2.64"	56
A		Magnetic Visual Pocket 1/3 DIN A4 Portrait - 8.3" x 3.9"	22
Adapter Plate D28	184	Magnetic Visual Pocket DIN A4 Portrait - 8.3" x 11.7"	23
Attached Visual Pocket 1/3 DIN A4 Portrait - 8.3" x 3.9"	16	Magnetic Visual Pocket DIN A5 Landscape - 8.3" x 5.8"	21
Attached Visual Pocket DIN A4 Portrait - 8.3" x 11.7"	17	Milling Connector I, Slot 8	182
Attached Visual Pocket DIN A5 Landscape - 8.3" x 5.8"	15	Monitor Support 4-axis, Height Adjustable	139
Automatic Connector Steel	177	Monitor Support 4-axis, Height Adjustable	140
Automatic Double Connector I, Slot 8 (Set)	178	Monitor Support 5-axis, Height Adjustable	141
C		Monitor Support 5-axis, Height Adjustable	142
Caution Forklift Zone Floor Sign	107	Monitor Work Station SIT / STAND 4-axis, Profile Attachment (Set)	143
Connecting Element for Guiding Rail FIFO (Set)	174	Monitor Work Station SIT / STAND 4-axis, Profile Attachment (Set)	144
Connecting Strip 140 I, Slot 8	175	Mounting Bracket ST D28	191
Cover Profile Slot 8 - 4.5	176	N	
D		No Entry Floor Sign	95
Disinfect Hands Sticker	118	No Entry Sticker	115
Drive Slowly Floor Sign	105	No Forklift Traffic Floor Sign	93
E		No Handshake Sticker	114
End Cap for Parking Rail High / High (Set)	162	No Pedestrian Floor Sign	97
End Cap for Parking Rail Low / High (Set)	161	No Smoking Floor Sign	96
End Cap for Parking Rail Low / Low (Set)	160	No Stopping Floor Sign	94
End Cap XL for Parking Rail High / High (Set)	164	O	
End Cap XL for Parking Rail Low / High (Set)	163	Overhanging KANBAN Label Holder	40
F		P	
Face Mask Sticker	116	Parking Rail High / High (Set)	159
Face Protection Sticker	117	Parking Rail Low / High (Set)	158
Floor Marking Foot Shape 90	85	Parking Rail Low / Low (Set)	157
Floor Marking I-shape 50	83	Pedestrian Route Floor Sign	104
Floor Marking I-shape 75	84	Plastic Pin for Visual Pocket	27
Floor Marking L-shape 50	81	Plastic Tie for Visual Pocket	28
Floor Marking L-shape 75	82	Plate Connector I ZN 40 (Set)	179
Floor Marking Tape 50	73	Position Marking End Cap for Parking Rail	165
Floor Marking Tape 75	74	R	
Floor Marking T-shape 50	79	Roller Track XST H26	188
Floor Marking T-shape 75	80	Roller Track XST R28	186
Floor Window 1/2 DIN A4 Landscape - 11.7" x 4.1"	89	Roller Track XST R28 mit Spurkranz	187
Floor Window 1/3 DIN A4 Portrait - 8.3" x 3.9"	87	Roll-in T-slot Nut 13.5 x 7.2 mm with Spring Loaded Ball	183
Floor Window DIN A4 - 8.3" x 11.7"	88	S	
Floor Window DIN A5 - 5.8" x 8.3"	86	Safe Distance Sticker	121
G		Safety Glasses Required Floor Sign	102
Guiding Rail FIFO (Set)	171	Safety Shoes Required Floor Sign	103
H		Safety Vest Required Floor Sign	99
Hard Hat Area Floor Sign	101	Screw Cover Infeed Cap for Guiding Rail FIFO	173
Holding Bracket ST D28	189	Self-adhesive KANBAN Label Holder	41
I		Self-adhesive Label Holder 20 - 0.8"	47
Infeed Cap for Guiding Rail FIFO (Set)	172	Self-adhesive Label Holder 27 - 1.06"	48
K		Self-adhesive Label Holder 38 - 1.5"	49
KANBAN Clip Document Holder 70 x 30 - 2.8" x 1.2"	39	Self-adhesive Label Holder 47 - 1.85"	50
L		Self-adhesive Label Holder 67 - 2.64"	51
Lattice Box Clip for Visual Pocket	26	Self-adhesive Visual Pocket 1/3 DIN A4 Portrait - 8.3" x 3.9"	19
M		Self-adhesive Visual Pocket DIN A4 Portrait - 8.3" x 11.7"	20
Magnetic Document Window DIN A3 - 11.7" x 16.5"	138	Self-adhesive Visual Pocket DIN A5 Landscape - 8.3" x 5.8"	18
Magnetic Document Window DIN A4 - 8.3" x 11.7"	137	Side Open KANBAN Envelope 200 x 67 - 7.9" x 2.6"	36
Magnetic KANBAN Label Holder	42	Side Open KANBAN Envelope 200 x 85 - 7.9" x 3.4"	37
Magnetic Label Holder 20 - 0.8"	52	Side Open KANBAN Envelope 200 x 135 - 7.9" x 5.3"	38
		Side Open Magnetic Label Envelope 60 - 2.4"	66
		Side Open Self-adhesive Label Envelope 60 - 2.4"	65
		SLC Wire Steel Clamp for Visual Pocket	24
		Stop Floor Sign	106
		T	
		T-connector Plate D28	185

Top Open KANBAN Envelope 200 x 67 - 7.9" x 2.6"	33
Top Open KANBAN Envelope 200 x 85 - 7.9" x 3.4"	34
Top Open KANBAN Envelope 200 x 135 - 7.9" x 5.3"	35
Top Open Magnetic Label Envelope 37 - 1.5"	63
Top Open Magnetic Label Envelope 50 - 2"	64
Top Open Self-adhesive Label Envelope 37 - 1.5"	61
Top Open Self-adhesive Label Envelope 50 - 2"	62
Traffic Arrow Floor Sign	100
Traffic Arrow Sticker	120

U

U-loop Steel Clamp for Visual Pocket	25
--------------------------------------	----

V

Variable Holding Bracket ST D28	190
---------------------------------	-----

W

Warning Slippery Surface Floor Sign	113
Wash Hands Sticker	119
Wear Hearing Protection Floor Sign	98

Z

Zinc Connection Angle 40 / 80 flat	181
Zinc Connection Angle 40 flat	180

A	
Abdeckprofil Nut 8 - 4,5	176
Adapterplatte D28	184
Anhänge-Sichttasche 1/3 DIN A4 hoch	16
Anhänge-Sichttasche DIN A4 hoch	17
Anhänge-Sichttasche DIN A5 quer	15
Augenschutz benutzen Bodenschild	102
Automatik-Doppelverbinder I, Nut 8 (Set)	178
Automatikverbinder Stahl	177
B	
Bodenfenster 1/2 DIN A4 quer	89
Bodenfenster 1/3 DIN A4 hoch	87
Bodenfenster DIN A4	88
Bodenfenster DIN A5	86
Bodenmarkierung Fuss-Form 90	85
Bodenmarkierung I-Form 50	83
Bodenmarkierung I-Form 75	84
Bodenmarkierung L-Form 50	81
Bodenmarkierung L-Form 75	82
Bodenmarkierungsband 50	73
Bodenmarkierungsband 75	74
Bodenmarkierung T-Form 50	79
Bodenmarkierung T-Form 75	80
Bügelklemme für Sichttasche	25
E	
Einführungskappe für Führungsschiene FIFO (Set)	172
Einhängehalter ST D28	189
Endkappe für Parkschiene flach / flach (Set)	160
Endkappe für Parkschiene flach / hoch (Set)	161
Endkappe für Parkschiene hoch / hoch (Set)	162
Endkappe XL für Parkschiene flach / hoch (Set)	163
Endkappe XL für Parkschiene hoch / hoch (Set)	164
F	
Fräsverbinder I, Nut 8	182
Führungsschiene FIFO (Set)	171
Für Flurförderzeuge verboten Bodenschild	93
Für Fußgänger verboten Bodenschild	97
Fußgängerweg benutzen Bodenschild	104
Fußschutz benutzen Bodenschild	103
G	
Gehörschutz tragen Bodenschild	98
Gesichtschutz benutzen Aufkleber	117
Gitterbox-Clip für Sichttasche	26
H	
Halteverbot Bodenschild	94
Hände desinfizieren Aufkleber	118
Händeschütteln verboten Aufkleber	114
Hände waschen Aufkleber	119
K	
KANBAN-Clip Dokumentenhalter 70 x 30	39
	24
Kopfschutz benutzen Bodenschild	101
Kunststoffbinder für Sichttasche	28
Kunststoffpiekser für Sichttasche	27
M	
Magnetische KANBAN-Etikettenhalter	42
Magnetischer Einsteckträger 20	52
Magnetischer Einsteckträger 27	53
Magnetischer Einsteckträger 38	54
Magnetischer Einsteckträger 47	55
Magnetischer Einsteckträger 67	56
Magnetisches Dokumentenfenster DIN A3	138
Magnetisches Dokumentenfenster DIN A4	137
Magnetische Sichttasche 1/3 DIN A4 hoch	22
Magnetische Sichttasche DIN A4 hoch	23
Magnetische Sichttasche DIN A5 quer	21
Maske benutzen Aufkleber	116
Monitor Arbeitsplatz SIT / STAND 4 Achsen, Profilverfestigung (Set)	143
Monitor Arbeitsplatz SIT / STAND 4 Achsen, Profilverfestigung (Set)	144
Monitorhalter 4 Achsen, höhenverstellbar	139
Monitorhalter 4 Achsen, höhenverstellbar	140
Monitorhalter 5 Achsen, höhenverstellbar	141
Monitorhalter 5 Achsen, höhenverstellbar	142
Montagehalter ST D28	191
N	
Nutenstein 13,5 x 7,2 mm, einschwenkbar mit Federkugel	183
O	
Oben offene KANBAN Hülle 200 x 67	33
Oben offene KANBAN Hülle 200 x 85	34
Oben offene KANBAN Hülle 200 x 135	35
Oben offene magnetische Etikettenhülle 37	63
Oben offene magnetische Etikettenhülle 50	64
Oben offene selbstklebende Etikettenhülle 37	61
Oben offene selbstklebende Etikettenhülle 50	62
P	
Parkschiene flach / flach (Set)	157
Parkschiene flach / hoch (Set)	158
Parkschiene hoch / hoch (Set)	159
Plattenverbinder I ZN 40 (Set)	179
Positionsmarkierung Endkappe für Parkschiene	165
R	
Rauchen verboten Bodenschild	96
Richtungshinweis Aufkleber	120
Richtungshinweis Bodenschild	100
Rollenschiene XST H26	188
Rollenschiene XST R28	186
Rollenschiene XST R28 with Flange	187
S	
Schraubenabdeckung Einführungskappe für Führungsschiene FIFO	173
Schritt fahren Bodenschild	105
Seitlich offene KANBAN Hülle 200 x 67	36
Seitlich offene KANBAN Hülle 200 x 85	37
Seitlich offene KANBAN Hülle 200 x 135	38
Seitlich offene magnetische Etikettenhülle 60	66
Seitlich offene selbstklebende Etikettenhülle 60	65
Selbstklebende KANBAN-Etikettenhalter	41
Selbstklebender Einsteckträger 20	47
Selbstklebender Einsteckträger 27	48
Selbstklebender Einsteckträger 38	49
Selbstklebender Einsteckträger 47	50
Selbstklebender Einsteckträger 67	51
Selbstklebende Sichttasche 1/3 DIN A4 hoch	19
Selbstklebende Sichttasche DIN A4 hoch	20
Selbstklebende Sichttasche DIN A5 quer	18
Sicherheitsabstand Aufkleber	121
Stop Bodenschild	106
Streckenverbinder 140 I, Nut 8	175
T	
T-Verbinderplatte D28	185
Ü	
Überhänge-KANBAN-Etikettenhalter	40
V	
Variabler Halter ST D28	190

Verbindungsblech für Führungsschiene FIFO (Set)	174
Verbot der Einfahrt Aufkleber	115
Verbot der Einfahrt Bodenschild	95

W

Warnung vor Flurförderzeugen Bodenschild	107
Warnung vor Rutschgefahr Bodenschild	113
Warnweste tragen Bodenschild	99

Z

Zinkwinkel 40 / 80 flach	181
Zinkwinkel 40 flach	180
Zweiseitig offene magnetische Etikettenhülle 37	59
Zweiseitig offene magnetische Etikettenhülle 50	60
Zweiseitig offene selbstklebende Etikettenhülle 37	57
Zweiseitig offene selbstklebende Etikettenhülle 50	58

FATH GmbH | Catalog LEAN 4.0
Edition 1.3 | EN-DE | Juli 2021

FATH GmbH | Gewerbepark Hügelmühle 31, 91174 Spalt, Germany
P: +49 9175 7909-200 | F: +49 9175 7909-29 | info.de@fath24.com | fath24.com

Managing Directors: Mirko Jan **FATH**, Wido **FATH**
Trade Register: Amtsgericht Nürnberg, Department B, No. 10906
Place of Execution: 91174 Spalt, Germany
Tax No.: 241/115/40086, VAT No.: DE 133 541 653

© **FATH** GmbH

Reprinting or other duplication, including excerpts, is possible only with the express permission of **FATH** GmbH.
We reserve the right to make technical modifications at any time. All indications are without guarantee.
Drawings and models are the intellectual property of **FATH** GmbH.
Our current Terms and Conditions of Sale, Delivery and Payment apply.

*Nachdruck oder sonstige Vervielfältigung, auch auszugsweise, nur mit ausdrücklicher Genehmigung der **FATH** GmbH.
Technische Änderungen vorbehalten. Alle Angaben ohne Gewähr.
Zeichnungen und Modelle sind urheberrechtlich geschützt.
Es gelten unsere aktuellen Allgemeinen Verkaufs-, Lieferungs- und Zahlungsbedingungen.*

Illustrations: Andreas Teindl, Dipl. Designer, Illustrator IO

simply practical

FATH®

COMPONENTS



VISUAL MANAGEMENT VISUAL MANAGEMENT

1 Container Labelings
Behälterkennzeichnungen

2 Shelf Labelings
Regalkennzeichnungen

3 Floor Markings
Bodenmarkierungen

4 Stickers
Aufkleber

5 Inserting Systems
Einstecksysteme

6 Visual Boards
Visual Boards

FATH GmbH
Gewerbepark Hügelmühle 31
91174 Spalt
Germany

P: +49 9175 7909-200
F: +49 9175 7909-29
info.de@fath24.com

FATH Inc.
6533 Hazeltine National Drive,
Suite 3
Orlando, FL 32822
USA

P: +1 407 601-5900
F: +1 407 601-5905
info.us@fath24.com

**FATH Machine Components
Co., Ltd**
Shengang Road No. 2001,
Building 2
201612 Songjiang / Shanghai
PR China

P: +86 21 5774 4520
info.cn@fath24.com

FATH Components Kft.
Gyár u. 2.
2040 Budaörs
Hungary

P: +36 23 880-977
F: +36 23 880-978
info.hu@fath24.com

FATH Components Ltd.
6 Pegasus Court, North Lane
Aldershot
Hampshire
GU12 4QP
Great Britain

P: +44 1252 346610
info.gb@fath24.com

FATH Inc. S.A. de C.V.
Av. Central 230, Int. 140
Los Lermas
67188 Guadalupe, N.L.
Mexico

P: +52 81 3424-1428
info.mx@fath24.com

**FATH do Brasil Componentes
Industriais Ltda**
Rodovia Raposo Tavares, S/N,
Km 22,14 Bloco E - 509 Granja
Viana.
Cotia - SP
06709 - 900
Brazil

P: +55 11 2898-9753
info.br@fath24.com

FATH Components BV
Rudolf Dieselweg 14
5928 RA Venlo
The Netherlands

P: +31 77 333 35 55
F: +31 77 333 35 50
info.nl@fath24.com

MATERIAL FLOW MATERIALFLUSS

7 Material Transport
Materialtransport

8 Material Supply
Materialbereitstellung

Presented by:
Überreicht von:

Best.-Nr. Order No. 000250

